

THE PEARL SNARE DRUM HOOP

2.3 mm of solid steel. Designed specifically for PEARL'S COMMANDER SNARE DRUM. Won't crack or bend and will take all the tension you need. Extra height makes rim shots easier.

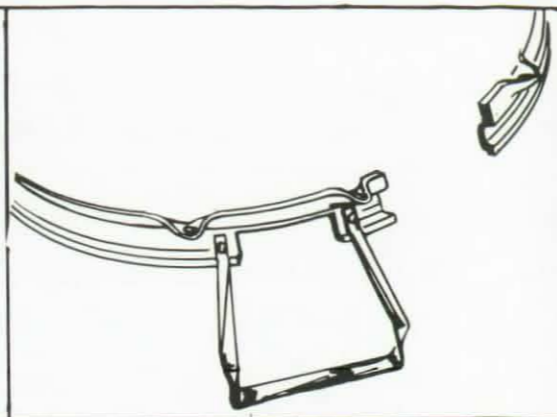

THE PEARL BASS DRUM HOOP

Solid rock maple 1/4" thick, 2 inches wide. The strongest bass drum hoop available for today's marching groups.

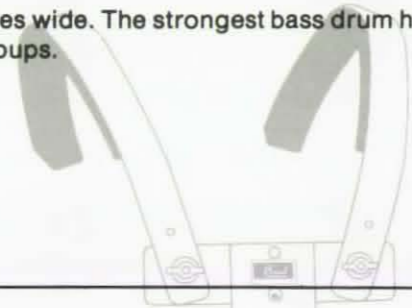

THE PEARL CLAW HOOK

Designed to fit PEARL'S BASS DRUM HOOP. The Claw Hook is reinforced to prevent "Pullout" and curves down further on the inside of the hoop for better hold.



THE PEARL STRAINER

A one sided throw-off designed specifically for the Commander Snare Drum, the Lightning Strainer, keeps the snares under full tension at all times. In the off position, the snares are completely lowered away from the head on both sides. Individual snare adjustment with either cable or gut snares. Only PEARL has it



THE PEARL CASINGS

Pearl has designed completely new, longer length, high tension casings for bass drum and snare drum to distribute stress more equally across the shell. Rugged die cast Chrome Plated for strength and beauty.

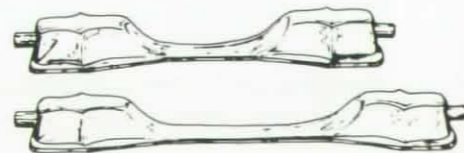

THE PEARL SNARE DRUM SHELL

5 Ply wood shell, cross laminated for superior strength, completely sealed inside and out. Optim-edge, the specially designed bearing edge found only on Pearl Marching Drums, with a specially designed snare bed for ultimate sensitivity.

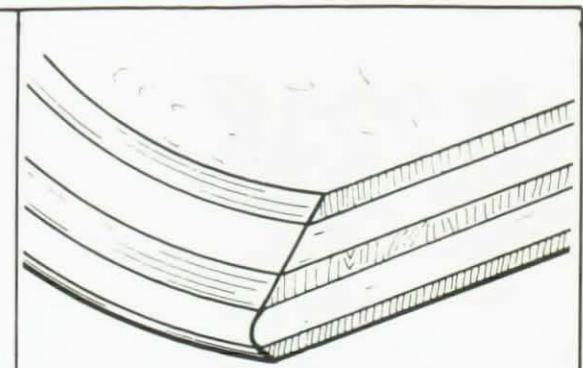

THE PEARL TIMP-TOM SHELL

6 Ply cross laminated maple, thick enough to withstand the roughest treatment, thin enough to provide resonant tone quality.

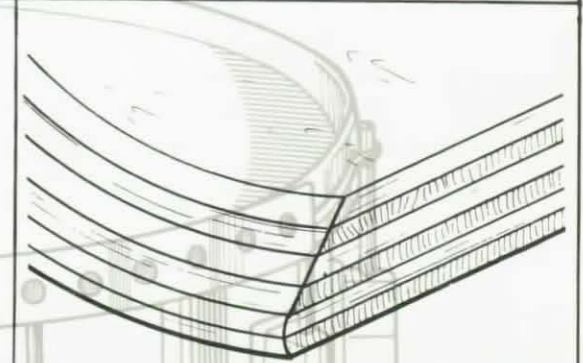
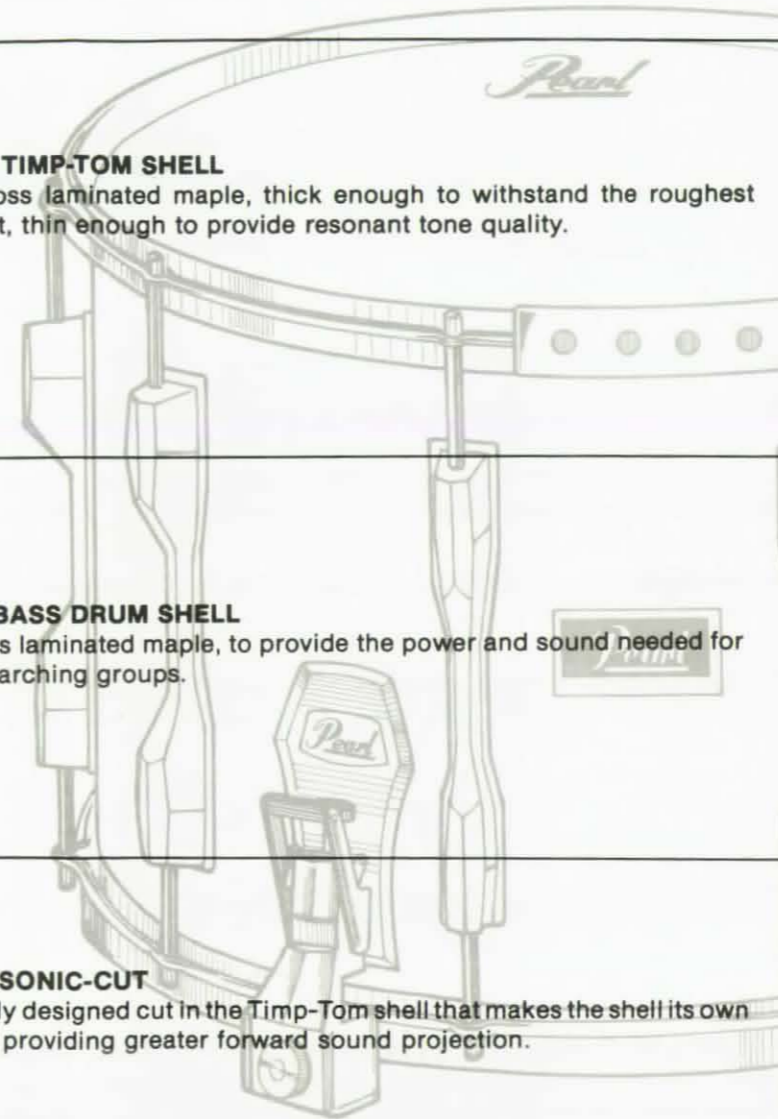

THE PEARL BASS DRUM SHELL

8 Ply cross laminated maple, to provide the power and sound needed for today's marching groups.

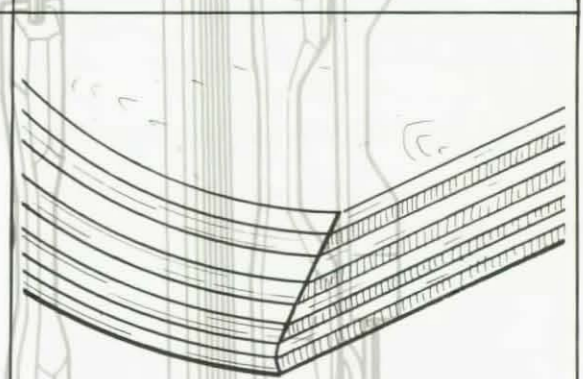

THE PEARL SONIC-CUT

A specially designed cut in the Timp-Tom shell that makes the shell its own reflector, providing greater forward sound projection.

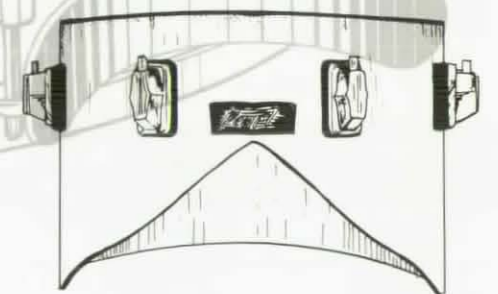

THE PEARL THUNDERHEAD

An extended collar design for Timp-Toms that slopes to a 1- oversize rim to provide booming power, truer pitch and greater projection.

