

# *Pearl*<sup>®</sup>

2 0 1 5

COMBO MARCHING CONCERT

P R I C E L I S T



EFFECTIVE JANUARY 1, 2015

# THE BEST WARRANTY IN THE INDUSTRY!

## COMMITTED TO THE HIGHEST LEVEL OF CUSTOMER SATISFACTION.

The Pearl Lifetime Warranty is a statement of confidence to our customers to the reliability of Pearl products. Pearl drums, stands and hardware are designed and manufactured to the highest standards in quality, style, appearance and playing performance. This lifetime warranty reflects a tradition of excellence and a commitment to superior engineering and craftsmanship dedicated to you, the drummer. The Pearl lifetime warranty is our pledge to you that we will proudly stand behind our product for as long as you own it. Buy it once, play it for life.

*Pearl*  
**LIFETIME**

- Drum Set/Concert wood and metal shells for the Lifetime of the Original Owner.
- Foot pedals, hi-hat stands, cymbals stands, boom cymbal stands, snare drum stands, throne bases, floor-standing tom stands, floor-standing cymbal/tom stands, concert stands, racks and rack accessories, cymbal holders and multi-clamps for the Lifetime of the Original Owner. Some exceptions apply.
- Drum Set claws, tension rods, swivel nuts, spurs, tom brackets, tom holders, strainers, and nuts and bolts for the Lifetime of the Original Owner.
- Rotationally molded cases for the Lifetime of the Original Owner.
- The LIFETIME WARRANTY applies to the aforementioned Pearl products purchased from June 15, 2009.

*Pearl*  
**3 YEARS**

- Marching Wood Shells.

*Pearl*  
**2 YEARS**

- All Pearl Percussion products (except rims, lugs, tuning plates and Taiko heads which have a 1 year warranty).
- All Roadshow drums, stands, pedals, hardware and parts.
- Crystal Beat drums, acrylic shells, lugs, hoops and parts (except OptiMounts which have a LIFETIME WARRANTY)

*Pearl*  
**1 YEAR**

- SoundCheck drums, stands, pedals, hardware, and parts.
- Covered and lacquered finishes on all Pearl drums.
- RH-2000 Remote Hat cable.
- Collar Joint on all Pearl drum thrones.
- Gas Cylinder on the D-3000TC throne.
- Marching claws, tension rods, swivel nuts, strainers, counterhoops, edge-rings and nuts and bolts.
- Marching carriers and marching carrier parts, except as noted below under "Consumables".
- Marching snare, tom and bass drum stands.
- Marching and Concert wood bass hoops (against manufacturer defect)
- Tru-Trac electronic drum pads and rubber pad surfaces.
- E-Pro Metal and Plastic Cymbals.
- R.E.D. BOX electronic drum module, cables, hi-hat controller, and junction boxes.
- THRONE THUMPER and THRONE THUMPER amplifier.
- PRECISION DRUM MONITOR headphones.
- Snare Kits, Bell Kits, Percussion Learning Centers and their corresponding bags and cases.
- All ADAMS products.
- TUNE-BOT electronic drum tuner

## THIS WARRANTY DOESN'T COVER:

- Normal wear and tear.
- Improper assembly.
- Improper follow-up maintenance or repair.
- Installation of non-genuine Pearl parts or components.
- Instruments that have been sold as "B-Stock", sold as second-hand, or resold contrary to US export regulations.
- Instruments that have been altered, modified or have been damaged through misuse, negligence, improper operation or accidents.
- Instruments subjected to abnormal strain, neglect, abuse, modification or exposure to extreme variances in temperature or humidity.
- Instruments whose trademark, name or identification number has been changed or removed.
- Drum hardware and stands plated in Black Chrome, Gold, Satin Chrome, and Black Nickel.
- Drum hardware and stands finished in Black or White Electro-coat.
- Consumables such as but not limited to: heads, sticks, brushes, beaters, springs, straps and buckles, marching slings, cushions and pads for marching carriers, throne tops and cushions, wire snares, cable snares, gut snares, cords/straps, cymbals, drum set, concert and marching bass drum hoops, bass drum hoop protectors, wheels and casters.
- The playing surface on Pearl Percussion Cajons.
- The head on the Pearl Percussion Fun Drum.

## OWNER'S RESPONSIBILITY:

It is important that the owner/user be familiar with the proper maintenance and use of their Pearl instrument. Keep this warranty and proof of purchase in a safe place. Be prepared to provide purchase information to avoid undue difficulties in determining eligibility for warranty protection.

## HOW TO OBTAIN WARRANTY SERVICE:

Warranty service may be obtained by first notifying the Pearl dealer from which the product was originally purchased. Upon notification, the Pearl dealer must obtain Return Authorization from the Pearl Customer Service Department. This number must be written plainly on the outside of the package or the returned shipping carton will be refused. Returned merchandise must be accompanied by a copy of the original sales receipt. All freight to and from Pearl is to be paid by the customer.

## WARRANTY LIMITATIONS:

This Warranty is exclusive and made in lieu of all other warranties, and all implied warranties, including without limitation any warranties of merchantability or of fitness for a particular purpose which are hereby expressly disclaimed. In no event will responsibility be accepted for incidental or consequential damages of any nature whatsoever. Some states do not allow limitation on how long an implied warranty may last. Therefore, the above limitations or exclusions may not apply to you.

This warranty gives you specific legal rights and you may also have other rights which vary from state to state.

Note: This WARRANTY applies to the United States only and may vary in other countries.

# PRODUCT INDEX

|  | Page  |   | Page    |
|--|-------|---|---------|
| WARRANTY .....                               | 2     | MARCHING PEARL CARRIERS & MARCHING STANDS ..... | 28      |
| DRUM SETS                                    |       | CASES & COVERS .....                            | 28      |
| MASTERWORKS .....                            | 4 - 5 | DRUM KEYS .....                                 | 28      |
| REFERENCE .....                              | 6     | MULTI-USE HOLDERS .....                         | 28      |
| REFERENCE PURE .....                         | 7     | STICK AND Mallet BAGS .....                     | 28      |
| MASTERS MCX .....                            | 8     | LALO PAD .....                                  | 28      |
| MASTERS BCX .....                            | 9     | SOUND PROJECTORS FOR SNARE DRUMS .....          | 28      |
| SESSION STUDIO CLASSIC SSC .....             | 10    | SLING ACCESSORIES .....                         | 28      |
| WOOD FIBERGLASS FW .....                     | 11    | Mallet HOLDERS .....                            | 28      |
| CRYSTAL BEAT CRB .....                       | 12    | TONE STRIPS .....                               | 28      |
| VISION BIRCH VBL .....                       | 13    | RIM SHOOTERS .....                              | 28      |
| EXPORT EXL .....                             | 14    | CHAMPIONSHIP CARBONPLY .....                    | 29      |
| EXPORT EXX .....                             | 15    | CHAMPIONSHIP MAPLE CARBONCORE .....             | 29 - 30 |
| ROADSHOW RS .....                            | 16    | CHAMPIONSHIP FFX SNARE DRUMS .....              | 31      |
| RHYTHM TRAVELER & RHYTHM TRAVELER POD .....  | 16    | CHAMPIONSHIP BASS DRUMS .....                   | 32 - 33 |
| ROCKET TOMS .....                            | 16    | CHAMPIONSHIP SONIC-CUT TENORS .....             | 34 - 35 |
| E-PRO POWERED BY EXPORT .....                | 17    | CHAMPIONSHIP SHALLOW CUT TENORS .....           | 36 - 37 |
| E-PRO COCKTAIL KIT .....                     | 18    | CHAMPIONSHIP TRADITIONAL TENORS .....           | 38      |
| TRU-TRAC CONVERSION KITS & ACCESSORIES ..... | 18    | COMPETITOR .....                                | 38      |
| SNARE DRUMS .....                            | 19    | PIPE BAND DRUMS .....                           | 38      |
| HARDWARE .....                               | 20    | REPLACEMENT HOOPS .....                         | 44      |
| ADAPTERS & ACCESSORIES .....                 | 21    | REPLACEMENT HEADS .....                         | 44      |
| DRUM PARTS .....                             | 21    | REPLACEMENT SNARES .....                        | 45      |
| HARDWARE PARTS .....                         | 22    | REPLACEMENT PARTS .....                         | 45      |
| REPLACEMENT HOOPS & HEADS .....              | 23    | CONCERT   |         |
| PEARL  |       | SNARE DRUMS .....                               | 39      |
| PERCUSSION                                   |       | TOMS & BASS DRUMS .....                         | 39      |
| SIGNATURE SERIES CONGAS & BONGOS .....       | 24    | STANDS .....                                    | 39      |
| ELITE SERIES CONGAS & BONGOS .....           | 24    | REPLACEMENT HEADS .....                         | 44      |
| HAVANA SERIES CONGAS & BONGOS .....          | 24    | REPLACEMENT HOOPS .....                         | 44      |
| FOLKLORIC SERIES CONGAS & BONGOS .....       | 24    | REPLACEMENT SNARES .....                        | 45      |
| PRIMERO PRO CONGAS & BONGOS .....            | 24    | REPLACEMENT PARTS .....                         | 45      |
| PRIMERO CONGAS & BONGOS .....                | 24    | ADAMS   |         |
| TRAVEL CONGAS .....                          | 24    | TIMPANI .....                                   | 40 - 41 |
| CAJONS .....                                 | 25    | TIMPANI KEY .....                               | 41      |
| DJEMBES .....                                | 25    | TIMPANI MUFFLER .....                           | 41      |
| FRAME DRUMS .....                            | 25    | TIMPANI BAGS & COVERS .....                     | 41      |
| TIMBALES .....                               | 25    | MARIMBAS .....                                  | 42      |
| STANDS .....                                 | 25    | XYLOPHONES .....                                | 42      |
| HOLDERS & ACCESSORIES .....                  | 25    | VIBRAPHONES .....                               | 42      |
| TRAP TABLES .....                            | 26    | CONCERT BASS DRUMS .....                        | 42      |
| ANARCHY SERIES .....                         | 26    | BELLS & GLOCKENSPIELS .....                     | 43      |
| COWBELLS .....                               | 26    | CHIMES .....                                    | 43      |
| BRAZILIAN PERCUSSION .....                   | 26    | BELL PLATES .....                               | 43      |
| FIELD PERCUSSION .....                       | 26    | UNIVERSITY FRAMES .....                         | 43      |
| BANDA PERCUSSION .....                       | 26    | ENDURANCE FIELD FRAMES .....                    | 43      |
| BAGS .....                                   | 26    | ENDURANCE FIELD FRAME RACK SYSTEM .....         | 43      |
| HAND PERCUSSION .....                        | 27    | ENDURANCE FIELD FRAME ATTACHMENTS .....         | 43      |
| REPLACEMENT PARTS .....                      | 27    | GONG STAND .....                                | 43      |
|  |       | Mallet INSTRUMENT BAGS & COVERS .....           | 43      |
|  |       | REPLACEMENT HEADS .....                         | 44      |
|  |       | ED KITS .....                                   | 44      |
|  |       | MARCHING & CONCERT COLOR CHART .....            | 46      |

## MASTERWORKS:

- CHOICE OF MAPLE, BIRCH, OR AFRICAN MAHOGANY SHELLS
- CHOICE OF SHELL THICKNESS (REFER TO THE SHELL THICKNESS CHARTS)
- CHOICE OF FIBERGLASS INNER PLY
- CHOICE OF SUPER HIGH GLOSS LACQUER FINISHES
- CHOICE OF SUPERHOOP II, DIE CAST HOOPS, FAT TONE HOOPS
- CHOICE BLACK CHROME, GOLD PLATED, OR CHROME PLATED HARDWARE
- GOLDEN RATIO AIR VENTS

## MASTERWORKS CARBONPLY MAPLE:

- 6 PLY 5.4MM MAPLE SHELLS
- CARBON FIBER INSIDE AND OUTSIDE
- CHOICE OF SUPERHOOP II, DIE CAST HOOPS, FAT TONE HOOPS
- CHOICE BLACK CHROME, GOLD PLATED, OR CHROME PLATED HARDWARE
- SAME PRICING AS MASTERWORKS
- GOLDEN RATIO AIR VENTS

## ARTISAN:

- CHOICE OF MAPLE, BIRCH, OR AFRICAN MAHOGANY SHELLS
- CHOICE OF SHELL THICKNESS (REFER TO THE SHELL THICKNESS CHARTS)
- CHOICE OF TAMO, BUBINGA OR EUCALYPTUS OUTER VENEERS
- CHOICE BLACK CHROME, GOLD PLATED, OR CHROME PLATED HARDWARE
- GOLDEN RATIO AIR VENTS

## SNARE DRUMS

| MODEL   | SIZE     | MASTERWORKS | ARTISAN SERIES |
|---------|----------|-------------|----------------|
| MW1040S | 10"x4"   | \$905.00    | \$994.00       |
| MW1055S | 10"x5.5" | 947.00      | 1,036.00       |
| MW1065S | 10"x6.5" | 968.00      | 1,178.00       |
| MW1240S | 12"x4"   | 968.00      | 1,063.00       |
| MW1255S | 12"x5.5" | 1,036.00    | 1,273.00       |
| MW1265S | 12"x6.5" | 1,036.00    | 1,284.00       |
| MW1340S | 13"x4"   | 968.00      | 1,105.00       |
| MW1355S | 13"x5.5" | 968.00      | 1,178.00       |
| MW1365S | 13"x6.5" | 1,089.00    | 1,342.00       |
| MW1450S | 14"x5"   | 1,157.00    | 1,368.00       |
| MW1455S | 14"x5.5" | 1,157.00    | 1,368.00       |
| MW1465S | 14"x6.5" | 1,215.00    | 1,542.00       |
| MW1480S | 14"x8"   | 1,215.00    | 1,542.00       |

## SNARE DRUMS - 20 PLY

| MODEL          | SIZE     | MASTERWORKS | ARTISAN SERIES |
|----------------|----------|-------------|----------------|
| MW1365S 20 PLY | 13"x6.5" | \$1,210.00  | \$1,331.00     |
| MW1450S 20 PLY | 14"x5"   | 1,426.00    | 1,573.00       |
| MW1465S 20 PLY | 14"x6.5" | 1,426.00    | 1,573.00       |

## SNARE DRUMS - ONE PLY MAPLE

| MODEL      | SIZE     | MASTERWORKS | ARTISAN SERIES |
|------------|----------|-------------|----------------|
| MW1450SOMC | 14"x5"   | 2,000.00    | n/a            |
| MW1455SOMC | 14"x5.5" | 2,000.00    | n/a            |
| MW1465SOMC | 14"x6.5" | 2,073.00    | n/a            |

### SNARE DRUM FEATURES:

- BRL-100 BRIDGE LUGS w/SWIVEL FUNCTION (ON SHELLS 6.5"+ DEEP)
- BRL-55/65 BRIDGE LUGS w/SWIVEL FUNCTION (ON SHELLS 5" ~ 6.5" DEEP)
- STL SWIVEL TUBE LUGS (CHROME ONLY) (ADD \$80 PER DRUM FOR TUBE LUGS)
- STL-100 SINGLE SWIVEL LUGS
- TB-50/55/65 TUBE LUGS (ON SHELLS 5", 5.5" & 6.5" DEEP) (ADD \$80 PER DRUM FOR TUBE LUGS)
- CL-05 LUGS (ON SHELLS 3" TO 4" DEEP)
- STAINLESS STEEL TENSION RODS
- SR-017, SR-015 GLADSTONE-STYLE OR SR-020 MULTI-TRACE STRAINER (ON SHELLS 5"+ DEEP)
- SR-018 STRAINER (ON SHELLS 3" TO 4" DEEP)
- "GOLDEN RATIO" AIR VENTS
- PEARL EXCLUSIVE COATED BATTER HEADS BY REMO
- EXCLUSIVE MASTERWORKS BADGE

## SNARE DRUM SHELL THICKNESS ✓ MAPLE ✓ BIRCH ✓ MAHOGANY

| DIAMETER | 1 PLY 7.5MM | 4 PLY 5MM | 6 PLY 7.5MM | 8 PLY 10MM | 10 PLY 12.5MM |
|----------|-------------|-----------|-------------|------------|---------------|
| 10"      | -           | ✓✓✓       | ✓✓✓         | -          | -             |
| 12"      | -           | ✓✓✓       | ✓✓✓         | ✓✓✓        | -             |
| 13"      | -           | ✓✓✓       | ✓✓✓         | ✓✓✓        | -             |
| 14"      | ✓✓✓         | ✓✓✓       | ✓✓✓         | ✓✓✓        | ✓✓✓           |

## BASS DRUMS

| MODEL   | SIZE    | MASTERWORKS | ARTISAN SERIES |
|---------|---------|-------------|----------------|
| MW1810B | 18"x10" | \$2,547.00  | \$3,468.00     |
| MW1811B | 18"x11" | 2,547.00    | 3,468.00       |
| MW1812B | 18"x12" | 2,547.00    | 3,468.00       |
| MW1813B | 18"x13" | 2,547.00    | 3,468.00       |
| MW1814B | 18"x14" | 2,547.00    | 3,468.00       |
| MW1815B | 18"x15" | 2,547.00    | 3,468.00       |
| MW1816B | 18"x16" | 2,547.00    | 3,468.00       |
| MW1817B | 18"x17" | 2,547.00    | 3,468.00       |
| MW1818B | 18"x18" | 2,547.00    | 3,468.00       |
| MW2010B | 20"x10" | 2,673.00    | 3,531.00       |
| MW2011B | 20"x11" | 2,673.00    | 3,531.00       |
| MW2012B | 20"x12" | 2,673.00    | 3,531.00       |
| MW2013B | 20"x13" | 2,673.00    | 3,531.00       |
| MW2014B | 20"x14" | 2,673.00    | 3,531.00       |
| MW2015B | 20"x15" | 2,673.00    | 3,531.00       |
| MW2016B | 20"x16" | 2,673.00    | 3,531.00       |
| MW2017B | 20"x17" | 2,673.00    | 3,531.00       |
| MW2018B | 20"x18" | 2,673.00    | 3,531.00       |
| MW2210B | 22"x10" | 2,857.00    | 3,705.00       |
| MW2211B | 22"x11" | 2,857.00    | 3,705.00       |
| MW2212B | 22"x12" | 2,857.00    | 3,705.00       |
| MW2213B | 22"x13" | 2,857.00    | 3,705.00       |
| MW2214B | 22"x14" | 2,857.00    | 3,705.00       |
| MW2215B | 22"x15" | 2,857.00    | 3,705.00       |
| MW2216B | 22"x16" | 2,857.00    | 3,705.00       |
| MW2217B | 22"x17" | 2,857.00    | 3,705.00       |
| MW2218B | 22"x18" | 2,857.00    | 3,705.00       |
| MW2220B | 22"x20" | 2,857.00    | 3,705.00       |
| MW2410B | 24"x10" | 2,915.00    | 3,821.00       |
| MW2411B | 24"x11" | 2,915.00    | 3,821.00       |
| MW2412B | 24"x12" | 2,915.00    | 3,821.00       |
| MW2413B | 24"x13" | 2,915.00    | 3,821.00       |
| MW2414B | 24"x14" | 2,915.00    | 3,821.00       |
| MW2415B | 24"x15" | 2,915.00    | 3,821.00       |
| MW2416B | 24"x16" | 2,915.00    | 3,821.00       |
| MW2417B | 24"x17" | 2,915.00    | 3,821.00       |
| MW2418B | 24"x18" | 2,915.00    | 3,821.00       |
| MW2610B | 26"x10" | 3,010.00    | 3,947.00       |
| MW2611B | 26"x11" | 3,010.00    | 3,947.00       |
| MW2612B | 26"x12" | 3,010.00    | 3,947.00       |
| MW2613B | 26"x13" | 3,010.00    | 3,947.00       |
| MW2614B | 26"x14" | 3,010.00    | 3,947.00       |
| MW2615B | 26"x15" | 3,010.00    | 3,947.00       |
| MW2616B | 26"x16" | 3,010.00    | 3,947.00       |

### BASS DRUM FEATURES:

- CHOICE OF CL, BRL OR STL LUGS
- CW-300 RECESSED DIE CAST CLAWS w/RUBBER "HOOP SAVERS"
- SP-300 BRIDGE SPURS
- 2" WIDE WOOD HOOPS
- STAINLESS STEEL TENSION RODS
- ORDER WITH OR WITHOUT BB-3 BRACKET
- "GOLDEN RATIO" AIR VENTS
- PEARL EXCLUSIVE REMO COATED POWERSTROKE 4 BATTER HEAD
- PEARL EXCLUSIVE REMO COATED POWERSTROKE 3 RESONATOR HEAD
- EXCLUSIVE MASTERWORKS BADGE



## BASS DRUM SHELL THICKNESS ✓ MAPLE ✓ BIRCH ✓ MAHOGANY

| DIAMETER | 4 PLY 5MM | 6 PLY 7.5MM | 8 PLY 10MM | 10 PLY 12.5MM |
|----------|-----------|-------------|------------|---------------|
| 18"      | ✓✓✓       | ✓✓✓         | ✓✓✓        | ✓✓✓           |
| 20"      | ✓✓✓       | ✓✓✓         | ✓✓✓        | ✓✓✓           |
| 22"      | ✓✓✓       | ✓✓✓         | ✓✓✓        | ✓✓✓           |
| 24"      | ✓✓✓       | ✓✓✓         | ✓✓✓        | ✓✓✓           |
| 26"      | ✓✓✓       | ✓✓✓         | -          | -             |

## TOMS

| MODEL   | SIZE    | MASTERWORKS | ARTISAN SERIES |
|---------|---------|-------------|----------------|
| MW0807T | 8"x7"   | \$973.00    | \$1,084.00     |
| MW0808T | 8"x8"   | 973.00      | 1,084.00       |
| MW1007T | 10"x7"  | 1,068.00    | 1,242.00       |
| MW1008T | 10"x8"  | 1,068.00    | 1,242.00       |
| MW1009T | 10"x9"  | 1,068.00    | 1,242.00       |
| MW1010T | 10"x10" | 1,068.00    | 1,242.00       |
| MW1207T | 12"x7"  | 1,147.00    | 1,368.00       |
| MW1208T | 12"x8"  | 1,147.00    | 1,368.00       |
| MW1209T | 12"x9"  | 1,147.00    | 1,368.00       |
| MW1210T | 12"x10" | 1,147.00    | 1,368.00       |
| MW1211T | 12"x11" | 1,147.00    | 1,368.00       |
| MW1212T | 12"x12" | 1,147.00    | 1,368.00       |
| MW1307T | 13"x7"  | 1,236.00    | 1,547.00       |
| MW1308T | 13"x8"  | 1,236.00    | 1,547.00       |
| MW1309T | 13"x9"  | 1,236.00    | 1,547.00       |
| MW1310T | 13"x10" | 1,236.00    | 1,547.00       |
| MW1311T | 13"x11" | 1,236.00    | 1,547.00       |
| MW1312T | 13"x12" | 1,236.00    | 1,547.00       |
| MW1313T | 13"x13" | 1,236.00    | 1,547.00       |
| MW1407T | 14"x7"  | 1,368.00    | 1,657.00       |
| MW1408T | 14"x8"  | 1,368.00    | 1,657.00       |
| MW1409T | 14"x9"  | 1,368.00    | 1,657.00       |
| MW1410T | 14"x10" | 1,368.00    | 1,657.00       |
| MW1411T | 14"x11" | 1,368.00    | 1,657.00       |
| MW1412T | 14"x12" | 1,368.00    | 1,657.00       |
| MW1413T | 14"x13" | 1,368.00    | 1,657.00       |
| MW1414T | 14"x14" | 1,368.00    | 1,657.00       |
| MW1507T | 15"x7"  | 1,484.00    | 1,815.00       |
| MW1508T | 15"x8"  | 1,484.00    | 1,815.00       |
| MW1509T | 15"x9"  | 1,484.00    | 1,815.00       |
| MW1510T | 15"x10" | 1,484.00    | 1,815.00       |
| MW1511T | 15"x11" | 1,484.00    | 1,815.00       |
| MW1512T | 15"x12" | 1,484.00    | 1,815.00       |
| MW1513T | 15"x13" | 1,484.00    | 1,815.00       |
| MW1514T | 15"x14" | 1,484.00    | 1,815.00       |
| MW1515T | 15"x15" | 1,484.00    | 1,815.00       |
| MW1607T | 16"x7"  | 1,563.00    | 1,968.00       |
| MW1608T | 16"x8"  | 1,563.00    | 1,968.00       |
| MW1609T | 16"x9"  | 1,563.00    | 1,968.00       |
| MW1610T | 16"x10" | 1,563.00    | 1,968.00       |
| MW1611T | 16"x11" | 1,563.00    | 1,968.00       |
| MW1612T | 16"x12" | 1,563.00    | 1,968.00       |
| MW1613T | 16"x13" | 1,563.00    | 1,968.00       |
| MW1614T | 16"x14" | 1,563.00    | 1,968.00       |
| MW1615T | 16"x15" | 1,563.00    | 1,968.00       |
| MW1616T | 16"x16" | 1,563.00    | 1,968.00       |

### TOM FEATURES:

- CHOICE OF CL, BRL OR STL LUGS
- CHOICE OF SUPERHOOP II, DIE CAST OR FAT TONE HOOPS
- STAINLESS STEEL TENSION RODS
- ALUMINUM OPTIMOUNT SUSPENSION SYSTEM
- "GOLDEN RATIO" AIR VENTS
- PEARL EXCLUSIVE COATED BATTER HEADS BY REMO
- EXCLUSIVE MASTERWORKS BADGE

### TOM SHELL THICKNESS

✓ MAPLE ✓ BIRCH ✓ MAHOGANY

| DIAMETER | 4 PLY 5MM | 6 PLY 7.5MM | 8 PLY 10MM | 10 PLY 12.5MM |
|----------|-----------|-------------|------------|---------------|
| 8"       | ✓✓✓       | ✓✓✓         | -          | -             |
| 10"      | ✓✓✓       | ✓✓✓         | ✓✓✓        | -             |
| 12"      | ✓✓✓       | ✓✓✓         | ✓✓✓        | -             |
| 13"      | ✓✓✓       | ✓✓✓         | ✓✓✓        | -             |
| 14"      | ✓✓✓       | ✓✓✓         | ✓✓✓        | ✓✓✓           |
| 15"      | ✓✓✓       | ✓✓✓         | ✓✓✓        | -             |
| 16"      | ✓✓✓       | ✓✓✓         | ✓✓✓        | ✓✓✓           |

## FLOOR TOMS

| MODEL   | SIZE    | MASTERWORKS | ARTISAN SERIES |
|---------|---------|-------------|----------------|
| MW1407F | 14"x7"  | \$1,589.00  | \$1,978.00     |
| MW1408F | 14"x8"  | 1,589.00    | 1,978.00       |
| MW1409F | 14"x9"  | 1,589.00    | 1,978.00       |
| MW1410F | 14"x10" | 1,589.00    | 1,978.00       |
| MW1411F | 14"x11" | 1,589.00    | 1,978.00       |
| MW1412F | 14"x12" | 1,589.00    | 1,978.00       |
| MW1413F | 14"x13" | 1,589.00    | 1,978.00       |
| MW1414F | 14"x14" | 1,589.00    | 1,978.00       |
| MW1507F | 15"x7"  | 1,642.00    | 2,142.00       |
| MW1508F | 15"x8"  | 1,642.00    | 2,142.00       |
| MW1509F | 15"x9"  | 1,642.00    | 2,142.00       |
| MW1510F | 15"x10" | 1,642.00    | 2,142.00       |
| MW1511F | 15"x11" | 1,642.00    | 2,142.00       |
| MW1512F | 15"x12" | 1,642.00    | 2,142.00       |
| MW1513F | 15"x13" | 1,642.00    | 2,142.00       |
| MW1514F | 15"x14" | 1,642.00    | 2,142.00       |
| MW1515F | 15"x15" | 1,642.00    | 2,142.00       |
| MW1607F | 16"x7"  | 1,700.00    | 2,200.00       |
| MW1608F | 16"x8"  | 1,700.00    | 2,200.00       |
| MW1609F | 16"x9"  | 1,700.00    | 2,200.00       |
| MW1610F | 16"x10" | 1,700.00    | 2,200.00       |
| MW1611F | 16"x11" | 1,700.00    | 2,200.00       |
| MW1612F | 16"x12" | 1,700.00    | 2,200.00       |
| MW1613F | 16"x13" | 1,700.00    | 2,200.00       |
| MW1614F | 16"x14" | 1,700.00    | 2,200.00       |
| MW1615F | 16"x15" | 1,700.00    | 2,200.00       |
| MW1616F | 16"x16" | 1,700.00    | 2,200.00       |
| MW1807F | 18"x7"  | 1,936.00    | 2,642.00       |
| MW1808F | 18"x8"  | 1,936.00    | 2,642.00       |
| MW1809F | 18"x9"  | 1,936.00    | 2,642.00       |
| MW1810F | 18"x10" | 1,936.00    | 2,642.00       |
| MW1811F | 18"x11" | 1,936.00    | 2,642.00       |
| MW1812F | 18"x12" | 1,936.00    | 2,642.00       |
| MW1813F | 18"x13" | 1,936.00    | 2,642.00       |
| MW1814F | 18"x14" | 1,936.00    | 2,642.00       |
| MW1815F | 18"x15" | 1,936.00    | 2,642.00       |
| MW1816F | 18"x16" | 1,936.00    | 2,642.00       |
| MW1817F | 18"x17" | 1,936.00    | 2,642.00       |
| MW1818F | 18"x18" | 1,936.00    | 2,642.00       |

### FLOOR TOM FEATURES:

- CHOICE OF CL, BRL OR STL LUGS
- LB-200 BRIDGE LEG BRACKET W/CLAM SHELL SYSTEM
- LG-200 FLOOR TOM LEGS w/AIR SUSPENSION FEET
- EXTRA LONG 27" LEGS (ON FLOOR TOMS 15" AND SHORTER IN DEPTH)
- CHOICE OF SUPERHOOP II, DIE CAST OR FAT TONE HOOPS
- STAINLESS STEEL TENSION RODS
- "GOLDEN RATIO" AIR VENTS
- PEARL EXCLUSIVE COATED BATTER HEADS BY REMO
- EXCLUSIVE MASTERWORKS BADGE



### FLOOR TOM SHELL THICKNESS

✓ MAPLE ✓ BIRCH ✓ MAHOGANY

| DIAMETER | 4 PLY 5MM | 6 PLY 7.5MM | 8 PLY 10MM | 10 PLY 12.5MM |
|----------|-----------|-------------|------------|---------------|
| 14"      | ✓✓✓       | ✓✓✓         | -          | ✓✓✓           |
| 15"      | ✓✓✓       | ✓✓✓         | ✓✓✓        | -             |
| 16"      | ✓✓✓       | ✓✓✓         | ✓✓✓        | ✓✓✓           |
| 18"      | ✓✓✓       | ✓✓✓         | ✓✓✓        | ✓✓✓           |

# RF REFERENCE

SHELL MATERIAL: "BEST OF MASTERWORKS"  
FINISHES: SUPER HIGH GLOSS LACQUER/LACQUER SPARKLES

## SHELL PACKS

**RF 924XP** ..... **\$5,830**

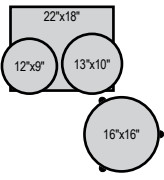

**INCLUDES:**

|           |         |           |
|-----------|---------|-----------|
| RF 2218BX | 22"x18" | BASS      |
| RF 1209T  | 12"x9"  | TOM       |
| RF 1310T  | 13"x10" | TOM       |
| RF 1616F  | 16"x16" | FLOOR TOM |

**RF 924XSP** ..... **\$5,830**

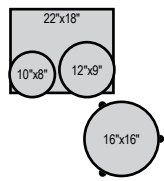

**INCLUDES:**

|           |         |           |
|-----------|---------|-----------|
| RF 2218BX | 22"x18" | BASS      |
| RF 1008T  | 10"x8"  | TOM       |
| RF 1209T  | 12"x9"  | TOM       |
| RF 1616F  | 16"x16" | FLOOR TOM |

**RF 904XP** ..... **\$5,830**

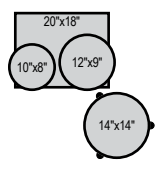

**INCLUDES:**

|           |         |           |
|-----------|---------|-----------|
| RF 2018BX | 20"x18" | BASS      |
| RF 1008T  | 10"x8"  | TOM       |
| RF 1209T  | 12"x9"  | TOM       |
| RF 1414F  | 14"x14" | FLOOR TOM |

## SHELL COMPOSITION

LEGEND: M= MAPLE; B= BIRCH; MH= AFRICAN MAHOGANY

| SNARE DRUMS | PLIES | THICKNESS | OUTSIDE / INSIDE | BEARING EDGE |
|-------------|-------|-----------|------------------|--------------|
| 13"         | 20    | 25MM      | M14 / B6         | 45°          |
| 14"         | 20    | 25MM      | M14 / B6         | 45°          |

| TOMS | PLIES | THICKNESS | OUTSIDE / INSIDE | BEARING EDGE  |
|------|-------|-----------|------------------|---------------|
| 8"   | 6     | 7.5MM     | M4 / B2          | ROUNDED 45°   |
| 10"  | 6     | 7.5MM     | M4 / B2          | ROUNDED 45°   |
| 12"  | 6     | 7.5MM     | M6               | ROUNDED 45°   |
| 13"  | 6     | 7.5MM     | M4 / MH2         | ROUNDED 45°   |
| 14"  | 6     | 7.5MM     | M4 / MH2         | FULLY ROUNDED |
| 15"  | 6     | 7.5MM     | M4 / MH2         | FULLY ROUNDED |
| 16"  | 6     | 7.5MM     | M2 / MH4         | FULLY ROUNDED |

| FLOOR TOMS | PLIES | THICKNESS | OUTSIDE / INSIDE | BEARING EDGE  |
|------------|-------|-----------|------------------|---------------|
| 14"        | 8     | 10MM      | M4 / MH4         | FULLY ROUNDED |
| 15"        | 8     | 10MM      | M4 / MH4         | FULLY ROUNDED |
| 16"        | 8     | 10MM      | M2 / MH6         | FULLY ROUNDED |
| 18"        | 8     | 10MM      | M2 / MH6         | FULLY ROUNDED |

| BASS DRUMS | PLIES | THICKNESS | OUTSIDE / INSIDE | BEARING EDGE  |
|------------|-------|-----------|------------------|---------------|
| 18"        | 6     | 7.5MM     | M2 / MH4         | FULLY ROUNDED |
| 20"        | 6     | 7.5MM     | M2 / MH4         | FULLY ROUNDED |
| 22"        | 8     | 10MM      | M2 / MH6         | FULLY ROUNDED |
| 24"        | 8     | 10MM      | M2 / MH6         | FULLY ROUNDED |

## COMPONENTS

| SNARE DRUMS |          |            |
|-------------|----------|------------|
| RF 1365S    | 13"x6.5" | \$1,250.00 |
| RF 1450S    | 14"x5"   | 1,200.00   |
| RF 1465S    | 14"x6.5" | 1,300.00   |
| RFS 1450    | 14"x5"   | 1,300.00   |
| RFS 1465    | 14"x6.5" | 1,365.00   |
| RFB 1450    | 14"x5"   | 1,650.00   |
| RFB 1465    | 14"x6.5" | 1,830.00   |

| TOMS      |         |          |
|-----------|---------|----------|
| RF 0807T  | 8"x7"   | \$730.00 |
| RF 0808T  | 8"x8"   | 730.00   |
| RF 1007T  | 10"x7"  | 850.00   |
| RF 1008T  | 10"x8"  | 850.00   |
| RF 1009T  | 10"x9"  | 850.00   |
| RF 1010T* | 10"x10" | 850.00   |
| RF 1208T  | 12"x8"  | 880.00   |
| RF 1209T  | 12"x9"  | 880.00   |
| RF 1210T  | 12"x10" | 880.00   |
| RF 1309T* | 13"x9"  | 980.00   |
| RF 1310T  | 13"x10" | 980.00   |
| RF 1311T* | 13"x11" | 980.00   |
| RF 1410T* | 14"x10" | 1,130.00 |
| RF 1411T  | 14"x11" | 1,130.00 |
| RF 1412T  | 14"x12" | 1,130.00 |
| RF 1513T* | 15"x13" | 1,180.00 |
| RF 1514T  | 15"x14" | 1,180.00 |
| RF 1613T  | 16"x13" | 1,280.00 |
| RF 1614T  | 16"x14" | 1,280.00 |

| FLOOR TOMS |         |            |
|------------|---------|------------|
| RF1414F    | 14"x14" | \$1,150.00 |
| RF1616F    | 16"x16" | 1,265.00   |
| RF1816F    | 18"x16" | 1,500.00   |

| BASS DRUMS w/BB-3     |         |            |
|-----------------------|---------|------------|
| RF 1814BB*            | 18"x14" | \$1,900.00 |
| RF 1816BB*            | 18"x16" | 1,900.00   |
| RF 2014BB*            | 20"x14" | 1,965.00   |
| RF 2016BB*            | 20"x16" | 1,965.00   |
| RF 2018BB*            | 20"x18" | 1,980.00   |
| <b>NEW</b> RF 2214BB* | 22"x14" | 2,265.00   |
| RF 2216BB*            | 22"x16" | 2,265.00   |
| RF 2218BB*            | 22"x18" | 2,265.00   |
| RF 2220BB*            | 22"x20" | 2,415.00   |
| <b>NEW</b> RF 2414BB* | 24"x14" | 2,415.00   |
| RF 2416BB*            | 24"x16" | 2,415.00   |
| RF 2418BB*            | 24"x18" | 2,450.00   |

| BASS DRUMS w/o BB-3   |         |            |
|-----------------------|---------|------------|
| RF 1814BX*            | 18"x14" | \$1,900.00 |
| RF 1816BX*            | 18"x16" | 1,900.00   |
| RF 2014BX*            | 20"x14" | 1,965.00   |
| RF 2016BX             | 20"x16" | 1,965.00   |
| RF 2018BX*            | 20"x18" | 1,980.00   |
| <b>NEW</b> RF 2214BX* | 22"x14" | 2,265.00   |
| RF 2216BX             | 22"x16" | 2,265.00   |
| RF 2218BX             | 22"x18" | 2,265.00   |
| RF 2220BX*            | 22"x20" | 2,415.00   |
| <b>NEW</b> RF 2414BX* | 24"x14" | 2,415.00   |
| RF 2416BX*            | 24"x16" | 2,415.00   |
| RF 2418BX             | 24"x18" | 2,450.00   |

| GONG DRUM w 2 X BB-3 |         |            |
|----------------------|---------|------------|
| RF 2014G*            | 20"x14" | \$1,565.00 |

\*SPECIAL ORDER ONLY  
PLEASE ALLOW 3 TO 5 MONTHS  
FOR DELIVERY

## FINISHES

| LACQUER w/CHROME, BLACK CHROME OR GOLD PLATED DRUM HARDWARE |                    |               |
|---|--------------------|---------------|
| #100  | WINE RED           | SPECIAL ORDER |
| #102  | NATURAL MAPLE      | IN STOCK      |
| #103  | PIANO BLACK        | IN STOCK      |
| #109  | ARCTIC WHITE       | SPECIAL ORDER |
| #126  | EMERALD MIST       | SPECIAL ORDER |
| #128  | VINTAGE SUNBURST   | SPECIAL ORDER |
| #142  | ROOTBEER FADE      | SPECIAL ORDER |
| #143  | TWILIGHT FADE      | SPECIAL ORDER |
| #148  | EMERALD FADE       | SPECIAL ORDER |
| #151  | PLATINUM MIST      | SPECIAL ORDER |
| #152  | ANTIQUÉ GOLD       | SPECIAL ORDER |
| #153  | SUNRISE FADE       | SPECIAL ORDER |
| #154  | MIDNIGHT FADE      | SPECIAL ORDER |
| #155  | SCARLET FADE       | SPECIAL ORDER |
| #197  | RHYTHM BLUE        | SPECIAL ORDER |
| #302  | INCA GOLD BURST    | SPECIAL ORDER |
| #330  | IVORY PEARL        | SPECIAL ORDER |
| #331  | BLACK PEARL        | SPECIAL ORDER |
| #332  | RED PEARL          | SPECIAL ORDER |
| #333  | PURPLE METALLIC    | SPECIAL ORDER |
| #334  | RED METALLIC       | SPECIAL ORDER |
| #335  | BLACK CHERRY       | SPECIAL ORDER |
| <b>NEW</b> #355   | *ANTIQUÉ WALNUT    | SPECIAL ORDER |
| <b>NEW</b> #356   | TANGERINE DREAM    | SPECIAL ORDER |
| #368  | BLACK SILVER BURST | SPECIAL ORDER |
| #376  | ULTRA BLUE FADE    | IN STOCK      |
| #393  | PURPLE CRAZE II    | SPECIAL ORDER |

## FEATURES

- BRL BRIDGE LUGS w/SWIVEL FUNCTION
- LB-200 BRIDGE FT LEG BRACKETS
- LG-200 FLOOR TOM LEGS
- SP-300 SPURS
- MASTERCASED DIE CAST HOOPS
- ALUMINUM OPTIMOUNT TOM HOLDERS
- STAINLESS STEEL TENSION RODS
- MOLDED RUBBER GASKETS
- REMO CLEAR EMPEROR TOM BATTERS
- REMO CLEAR POWERSTROKE3 BD BATTER
- REMO "WINDOW" SNARE BATTER HEAD
- LIFETIME WARRANTY
- CHOICE OF CHROME (C), GOLD PLATED (G) OR BLACK CHROME PLATED (B) DRUM HARDWARE BY SPECIAL ORDER\*

\*NOT AVAILABLE ON REFERENCE BRASS OR STEEL SNARE DRUMS



# RFP REFERENCE PURE

SHELL MATERIAL: EVENPLY MAPLE, BIRCH & AFRICAN MAHOGANY  
FINISHES: SUPER HIGH GLOSS LACQUER/LACQUER SPARKLES

## SHELL PACKS

**RFP 924XP** ..... **\$5,830**

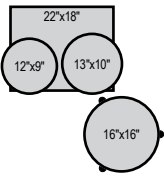

**INCLUDES:**  
**RFP 2218BX** 22"x18" BASS  
**RFP 1209T** 12"x9" TOM  
**RFP 1310T** 13"x10" TOM  
**RFP 1616F** 16"x16" FLOOR TOM

**RFP 924XSP** ..... **\$5,830**

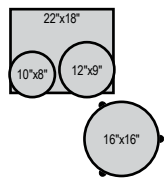

**INCLUDES:**  
**RFP 2218BX** 22"x18" BASS  
**RFP 1008T** 10"x8" TOM  
**RFP 1209T** 12"x9" TOM  
**RFP 1616F** 16"x16" FLOOR TOM

**RFP 904XP** ..... **\$5,830**

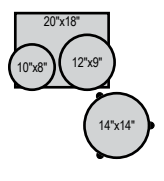

**INCLUDES:**  
**RFP 2018BX** 20"x18" BASS  
**RFP 1008T** 10"x8" TOM  
**RFP 1209T** 12"x9" TOM  
**RFP 1414F** 14"x14" FLOOR TOM

## SHELL COMPOSITION

LEGEND: M= MAPLE; B= BIRCH; MH= AFRICAN MAHOGANY

| SNARE DRUMS | PLIES | THICKNESS | OUTSIDE / INSIDE | BEARING EDGE |
|-------------|-------|-----------|------------------|--------------|
| 13"         | 6     | 5.4MM     | M4 / B2          | 45°          |
| 14"         | 6     | 5.4MM     | M4 / B2          | 45°          |

| TOMS | PLIES | THICKNESS | OUTSIDE / INSIDE | BEARING EDGE  |
|------|-------|-----------|------------------|---------------|
| 8"   | 6     | 5.4MM     | M4 / B2          | ROUNDED 45°   |
| 10"  | 6     | 5.4MM     | M4 / B2          | ROUNDED 45°   |
| 12"  | 6     | 5.4MM     | M6               | ROUNDED 45°   |
| 13"  | 6     | 5.4MM     | M4 / MH2         | ROUNDED 45°   |
| 14"  | 6     | 5.4MM     | M4 / MH2         | FULLY ROUNDED |
| 15"  | 6     | 5.4MM     | M4 / MH2         | FULLY ROUNDED |
| 16"  | 6     | 5.4MM     | M2 / MH4         | FULLY ROUNDED |

| FLOOR TOMS | PLIES | THICKNESS | OUTSIDE / INSIDE | BEARING EDGE  |
|------------|-------|-----------|------------------|---------------|
| 14"        | 8     | 7.2MM     | M4 / MH4         | FULLY ROUNDED |
| 15"        | 8     | 7.2MM     | M4 / MH4         | FULLY ROUNDED |
| 16"        | 8     | 7.2MM     | M2 / MH6         | FULLY ROUNDED |
| 18"        | 8     | 7.2MM     | M2 / MH6         | FULLY ROUNDED |

| BASS DRUMS | PLIES | THICKNESS | OUTSIDE / INSIDE | BEARING EDGE  |
|------------|-------|-----------|------------------|---------------|
| 18"        | 6     | 5.4MM     | M2 / MH4         | FULLY ROUNDED |
| 20"        | 6     | 5.4MM     | M2 / MH4         | FULLY ROUNDED |
| 22"        | 8     | 7.2MM     | M2 / MH6         | FULLY ROUNDED |
| 24"        | 8     | 7.2MM     | M2 / MH6         | FULLY ROUNDED |

## COMPONENTS

| SNARE DRUMS |          |          |
|-------------|----------|----------|
| RFP 1365S/C | 13"x6.5" | \$980.00 |
| RFP 1450S/C | 14"x5"   | 1,050.00 |
| RFP 1465S/C | 14"x6.5" | 1,100.00 |

| TOMS         |         |          |
|--------------|---------|----------|
| RFP 0807T/C  | 8"x7"   | \$730.00 |
| RFP 0808T/C  | 8"x8"   | 730.00   |
| RFP 1007T/C  | 10"x7"  | 850.00   |
| RFP 1008T/C  | 10"x8"  | 850.00   |
| RFP 1009T/C  | 10"x9"  | 850.00   |
| RFP 1010T/C* | 10"x10" | 850.00   |
| RFP 1208T/C  | 12"x8"  | 880.00   |
| RFP 1209T/C  | 12"x9"  | 880.00   |
| RFP 1210T/C  | 12"x10" | 880.00   |
| RFP 1309T/C* | 13"x9"  | 980.00   |
| RFP 1310T/C  | 13"x10" | 980.00   |
| RFP 1311T/C* | 13"x11" | 980.00   |
| RFP 1410T/C* | 14"x10" | 1,130.00 |
| RFP 1411T/C  | 14"x11" | 1,130.00 |
| RFP 1412T/C  | 14"x12" | 1,130.00 |
| RFP 1513T/C* | 15"x13" | 1,180.00 |
| RFP 1514T/C  | 15"x14" | 1,180.00 |
| RFP 1613T/C  | 16"x13" | 1,280.00 |
| RFP 1614T/C  | 16"x14" | 1,280.00 |

| FLOOR TOMS  |         |            |
|-------------|---------|------------|
| RFP 1414F/C | 14"x14" | \$1,150.00 |
| RFP 1616F/C | 16"x16" | 1,265.00   |
| RFP 1816F/C | 18"x16" | 1,500.00   |

| BASS DRUMS w/BB-3        |         |            |
|--------------------------|---------|------------|
| RFP 1814BB/C*            | 18"x14" | \$1,900.00 |
| RFP 1816BB/C*            | 18"x16" | 1,900.00   |
| RFP 2014BB/C*            | 20"x14" | 1,965.00   |
| RFP 2016BB/C*            | 20"x16" | 1,965.00   |
| RFP 2018BB/C*            | 20"x18" | 1,980.00   |
| <b>NEW</b> RFP 2214BB/C* | 22"x14" | 2,265.00   |
| RFP 2216BB/C*            | 22"x16" | 2,265.00   |
| RFP 2218BB/C*            | 22"x18" | 2,265.00   |
| RFP 2220BB/C*            | 22"x20" | 2,415.00   |
| <b>NEW</b> RFP 2414BB/C* | 24"x14" | 2,415.00   |
| RFP 2416BB/C*            | 24"x16" | 2,415.00   |
| RFP 2418BB/C*            | 24"x18" | 2,450.00   |

| BASS DRUMS w/O BB-3      |         |            |
|--------------------------|---------|------------|
| RFP 1814BX/C*            | 18"x14" | \$1,900.00 |
| RFP 1816BX/C*            | 18"x16" | 1,900.00   |
| RFP 2014BX/C*            | 20"x14" | 1,965.00   |
| RFP 2016BX/C*            | 20"x16" | 1,965.00   |
| RFP 2018BX/C*            | 20"x18" | 1,980.00   |
| <b>NEW</b> RFP 2214BX/C  | 22"x14" | 2,265.00   |
| RFP 2216BX/C             | 22"x16" | 2,265.00   |
| RFP 2218BX/C             | 22"x18" | 2,265.00   |
| RFP 2220BX/C*            | 22"x20" | 2,415.00   |
| <b>NEW</b> RFP 2414BX/C* | 24"x14" | 2,415.00   |
| RFP 2416BX/C*            | 24"x16" | 2,415.00   |
| RFP 2418BX/C             | 24"x18" | 2,450.00   |

| GONG DRUM w/ 2 X BB-3 |         |            |
|-----------------------|---------|------------|
| RFP 2014G/C*          | 20"x14" | \$1,565.00 |

\*SPECIAL ORDER ONLY  
PLEASE ALLOW 3 TO 5 MONTHS  
FOR DELIVERY

## FINISHES

| LACQUER w/CHROME PLATED DRUM HARDWARE |  |               |
|---------------------------------------|--|---------------|
| #100 WINE RED                         |  | SPECIAL ORDER |
| #102 NATURAL MAPLE                    |  | IN STOCK      |
| #103 PIANO BLACK                      |  | IN STOCK      |
| #109 ARCTIC WHITE                     |  | SPECIAL ORDER |
| #126 EMERALD MIST                     |  | SPECIAL ORDER |
| #128 VINTAGE SUNBURST                 |  | SPECIAL ORDER |
| #142 ROOTBEER FADE                    |  | SPECIAL ORDER |
| #143 TWILIGHT FADE                    |  | SPECIAL ORDER |
| #148 EMERALD FADE                     |  | SPECIAL ORDER |
| #151 PLATINUM MIST                    |  | SPECIAL ORDER |
| #152 ANTIQUE GOLD                     |  | SPECIAL ORDER |
| #153 SUNRISE FADE                     |  | SPECIAL ORDER |
| #154 MIDNIGHT FADE                    |  | SPECIAL ORDER |
| #155 SCARLET FADE                     |  | SPECIAL ORDER |
| #197 RHYTHM BLUE                      |  | SPECIAL ORDER |
| #302 INCA GOLD BURST                  |  | SPECIAL ORDER |
| #330 IVORY PEARL                      |  | SPECIAL ORDER |
| #331 BLACK PEARL                      |  | SPECIAL ORDER |
| #332 RED PEARL                        |  | SPECIAL ORDER |
| #333 PURPLE METALLIC                  |  | SPECIAL ORDER |
| #334 RED METALLIC                     |  | SPECIAL ORDER |
| #335 BLACK CHERRY                     |  | SPECIAL ORDER |
| #342 VINTAGE TOBACCO BURST            |  | SPECIAL ORDER |
| <b>NEW</b> #356 TANGERINE DREAM       |  | SPECIAL ORDER |
| <b>NEW</b> #355 *ANTIQUE WALNUT       |  | SPECIAL ORDER |
| #368 BLACK SILVER BURST               |  | SPECIAL ORDER |
| #377 SCARLET SPARKLE BURST            |  | IN STOCK      |
| #393 PURPLE CRAZE II                  |  | SPECIAL ORDER |

## FEATURES

- LOW MASS EVEN-PLY SHELLS
- LOW MASS STL SWIVEL TUBE LUGS
- LOW MASS FAT TONE HOOPS
- LB-200 BRIDGE FT LEG BRACKETS
- LG-200 FLOOR TOM LEGS
- SP-300 SPURS
- ALUMINUM OPTIMOUNT TOM HOLDERS
- STAINLESS STEEL TENSION RODS
- MOLDED RUBBER GASKETS
- REMO CLEAR EMPEROR TOM BATTERS
- REMO CLEAR POWERSTROKE3 BD BATTER
- REMO "WINDOW" SNARE BATTER HEAD
- LIFETIME WARRANTY



# MCX MASTERS MAPLE

SHELL MATERIAL: 6 PLY 7.5MM 100% MAPLE  
FINISH: ARTISAN II & SUPER HIGH GLOSS LACQUER

## SHELL PACKS

### MCX 924XP/C ..... \$2,999

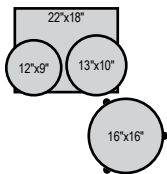

INCLUDES:  
**MCX 2218BX** 22"x18" BASS  
**MCX 1209T** 12"x9" TOM  
**MCX 1310T** 13"x10" TOM  
**MCX 1616F** 16"x16" FLOOR TOM

### MCX 924XSP/C ..... \$2,999

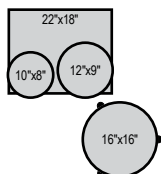

INCLUDES:  
**MCX 2218BX** 22"x18" BASS  
**MCX 1008T** 10"x8" TOM  
**MCX 1209T** 12"x9" TOM  
**MCX 1616F** 16"x16" FLOOR TOM

### MCX 904XP/C ..... \$2,999

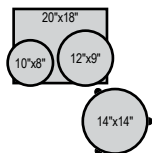

INCLUDES:  
**MCX 2018BX** 20"x18" BASS  
**MCX 1008T** 10"x8" TOM  
**MCX 1209T** 12"x9" TOM  
**MCX 1414F** 14"x14" FLOOR TOM

## COMPONENTS

### SNARE DRUMS

|             |          |          |
|-------------|----------|----------|
| MCX 1455S/C | 14"x5.5" | \$640.00 |
| MCX 1465S/C | 14"x6.5" | 680.00   |

### TOMS w/OPTIMOUNT

|              |         |          |
|--------------|---------|----------|
| MCX 0807T/C  | 8"x7"   | \$490.00 |
| MCX 0808T/C  | 8"x8"   | 490.00   |
| MCX 1007T/C  | 10"x7"  | 590.00   |
| MCX 1008T/C  | 10"x8"  | 590.00   |
| MCX 1009T/C  | 10"x9"  | 590.00   |
| MCX 1010T/C* | 10"x10" | 590.00   |
| MCX 1208T/C* | 12"x8"  | 640.00   |
| MCX 1209T/C  | 12"x9"  | 640.00   |
| MCX 1210T/C  | 12"x10" | 640.00   |
| MCX 1309T/C* | 13"x9"  | 690.00   |
| MCX 1310T/C* | 13"x10" | 690.00   |
| MCX 1311T/C  | 13"x11" | 690.00   |
| MCX 1411T/C  | 14"x11" | 790.00   |
| MCX 1412T/C  | 14"x12" | 790.00   |
| MCX 1513T/C* | 15"x13" | 850.00   |
| MCX 1514T/C  | 15"x14" | 850.00   |
| MCX 1613T/C  | 16"x13" | 940.00   |
| MCX 1614T/C  | 16"x14" | 940.00   |

### FLOOR TOMS

|             |         |          |
|-------------|---------|----------|
| MCX 1414F/C | 14"x14" | \$900.00 |
| MCX 1616F/C | 16"x16" | 1,000.00 |
| MCX 1816F/C | 18"x16" | 1,200.00 |

### BASS DRUMS w/o BB-3

|               |         |            |
|---------------|---------|------------|
| MCX 1814BX/C* | 18"x14" | \$1,540.00 |
| MCX 1816BX/C* | 18"x16" | 1,540.00   |
| MCX 2016BX/C  | 20"x16" | 1,600.00   |
| MCX 2018BX/C  | 20"x18" | 1,600.00   |
| MCX 2216BX/C  | 22"x16" | 1,700.00   |
| MCX 2218BX/C  | 22"x18" | 1,700.00   |
| MCX 2416BX/C* | 24"x16" | 1,800.00   |
| MCX 2418BX/C  | 24"x18" | 1,800.00   |

\*SPECIAL ORDER ONLY  
PLEASE ALLOW 3-5 MONTHS FOR DELIVERY

## FINISHES

### SUPER HIGH-GLOSS & ARTISAN II LACQUER

|                               |                  |
|-------------------------------|------------------|
| #103 PIANO BLACK              | w/CHROME DRUM HW |
| #388 SHAMROCK GREEN           | w/CHROME DRUM HW |
| #800 QUILTED BUBINGA SUNBURST | w/CHROME DRUM HW |
| #807 NATURAL BIRDSEYE MAPLE   | w/CHROME DRUM HW |
| #810 ASH FADE TAMO            | w/CHROME DRUM HW |

## FEATURES

- ARTISAN II LACQUER FINISHES
- 100% MAPLE SHELLS
- 100% MAPLE BASS DRUM HOOPS
- MASTERS BRIDGE LUGS
- MASTERCASED DIE CAST HOOPS ON TOMS
- OPTIMOUNT TOM HOLDERS
- MOLDED RUBBER GASKETS
- REMO HEADS
- LIFETIME WARRANTY





# BCX MASTERS BIRCH

SHELL MATERIAL: 6 PLY 7.5MM 100% BIRCH  
FINISH: ARTISAN II & SUPER HIGH GLOSS LACQUER

## SHELL PACKS

### BCX 924XP/C ..... \$2,499

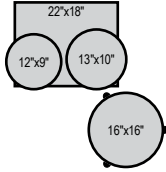

INCLUDES:  
**BCX 2218BX** 22"x18" BASS  
**BCX 1209T** 12"x9" TOM  
**BCX 1310T** 13"x10" TOM  
**BCX 1616F** 16"x16" FLOOR TOM

### BCX 924XSP/C ..... \$2,499

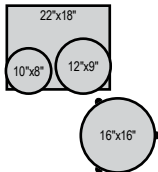

INCLUDES:  
**BCX 2218BX** 22"x18" BASS  
**BCX 1008T** 10"x8" TOM  
**BCX 1209T** 12"x9" TOM  
**BCX 1616F** 16"x16" FLOOR TOM

### BCX 904XP/C ..... \$2,499

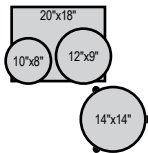

INCLUDES:  
**BCX 2018BX** 20"x18" BASS  
**BCX 1008T** 10"x8" TOM  
**BCX 1209T** 12"x9" TOM  
**BCX 1414F** 14"x14" FLOOR TOM

## COMPONENTS

### SNARE DRUMS

|             |          |          |
|-------------|----------|----------|
| BCX 1455S/C | 14"x5.5" | \$500.00 |
| BCX 1465S/C | 14"x6.5" | 530.00   |

### TOMS w/OPTIMOUNT

|              |         |          |
|--------------|---------|----------|
| BCX 0807T/C  | 8"x7"   | \$430.00 |
| BCX 0808T/C  | 8"x8"   | 430.00   |
| BCX 1007T/C  | 10"x7"  | 465.00   |
| BCX 1008T/C  | 10"x8"  | 465.00   |
| BCX 1009T/C  | 10"x9"  | 465.00   |
| BCX 1010T/C* | 10"x10" | 465.00   |
| BCX 1208T/C* | 12"x8"  | 500.00   |
| BCX 1209T/C  | 12"x9"  | 500.00   |
| BCX 1210T/C  | 12"x10" | 500.00   |
| BCX 1309T/C* | 13"x9"  | 550.00   |
| BCX 1310T/C* | 13"x10" | 550.00   |
| BCX 1311T/C  | 13"x11" | 550.00   |
| BCX 1411T/C  | 14"x11" | 600.00   |
| BCX 1412T/C  | 14"x12" | 600.00   |
| BCX 1513T/C* | 15"x13" | 650.00   |
| BCX 1514T/C  | 15"x14" | 650.00   |
| BCX 1613T/C  | 16"x13" | 730.00   |
| BCX 1614T/C  | 16"x14" | 730.00   |

### FLOOR TOMS

|             |         |          |
|-------------|---------|----------|
| BCX 1414F/C | 14"x14" | \$680.00 |
| BCX 1616F/C | 16"x16" | 765.00   |
| BCX 1816F/C | 18"x16" | 900.00   |

### BASS DRUMS w/o BB-3

|               |         |            |
|---------------|---------|------------|
| BCX 1814BX/C* | 18"x14" | \$1,130.00 |
| BCX 1816BX/C* | 18"x16" | 1,130.00   |
| BCX 2016BX/C  | 20"x16" | 1,165.00   |
| BCX 2018BX/C  | 20"x18" | 1,165.00   |
| BCX 2216BX/C  | 22"x16" | 1,230.00   |
| BCX 2218BX/C  | 22"x18" | 1,230.00   |
| BCX 2416BX/C* | 24"x16" | 1,300.00   |
| BCX 2418BX/C  | 24"x18" | 1,300.00   |

\*SPECIAL ORDER ONLY  
PLEASE ALLOW 3-5 MONTHS FOR DELIVERY

## FINISHES

### SUPER HIGH-GLOSS & ARTISAN II LACQUER

|                            |                  |
|----------------------------|------------------|
| #357 GOLDEN BRONZE GLITTER | w/CHROME DRUM HW |
| #358 SILVER GLITTER        | w/CHROME DRUM HW |
| #818 LAVA BUBINGA          | w/CHROME DRUM HW |

## FEATURES

- ARTISAN II LACQUER FINISHES
- 100% BIRCH SHELLS
- 100% BIRCH BASS DRUM HOOPS
- MASTERS BRIDGE LUGS
- MASTERCAST DIE CAST HOOPS ON TOMS
- OPTIMOUNT TOM HOLDERS
- MOLDED RUBBER GASKETS
- REMO HEADS
- LIFETIME WARRANTY



# SSC SESSION STUDIO CLASSIC

SHELL MATERIAL: 6 PLY 7.5MM BIRCH/KAPUR SHELLS  
FINISH: SUPER HIGH GLOSS LACQUER

## SHELL PACKS

### SSC 924XUP/C ..... \$1,999

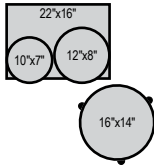

INCLUDES:  
**SSC 2216BX** 22"x16" BASS  
**SSC 1007T** 10"x7" TOM  
**SSC 1208T** 12"x8" TOM  
**SSC 1614F** 16"x14" FLOOR TOM

### SSC 944XUP/C ..... \$1,999

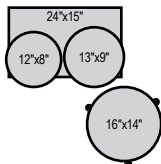

INCLUDES:  
**SSC 2415BX** 24"x15" BASS  
**SSC 1208T** 12"x8" TOM  
**SSC 1309T** 13"x9" TOM  
**SSC 1614F** 16"x14" FLOOR TOM

### SSC 904XUP/C ..... \$1,999

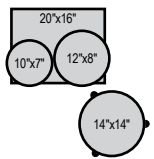

INCLUDES:  
**SSC 2016BX** 20"x16" BASS  
**SSC 1007T** 10"x7" TOM  
**SSC 1208T** 12"x8" TOM  
**SSC 1414F** 14"x14" FLOOR TOM

## COMPONENTS

### SNARE DRUMS

|             |          |          |
|-------------|----------|----------|
| SSC 1455S/C | 14"x5.5" | \$350.00 |
| SSC 1465S/C | 14"x6.5" | 380.00   |

### TOMS w/OPTIMUMT

|             |         |          |
|-------------|---------|----------|
| SSC 1007T/C | 10"x7"  | \$380.00 |
| SSC 1208T/C | 12"x8"  | 415.00   |
| SSC 1309T/C | 13"x9"  | 430.00   |
| SSC 1410T/C | 14"x10" | 465.00   |

### FLOOR TOMS

|              |         |          |
|--------------|---------|----------|
| SSC 1414F/C  | 14"x14" | \$550.00 |
| SSC 1614F/C  | 16"x14" | 615.00   |
| SSC 1616F/C* | 16"x16" | 615.00   |
| SSC 1816F/C* | 18"x16" | 715.00   |

### BASS DRUMS w/o BB-3

|              |         |            |
|--------------|---------|------------|
| SSC 2016BX/C | 20"x16" | \$1,080.00 |
| SSC 2216BX/C | 22"x16" | 1,180.00   |
| SSC 2415BX/C | 24"x15" | 1,250.00   |

\*SPECIAL ORDER - PLEASE ALLOW 3 TO 5 MONTHS FOR DELIVERY

## FINISHES

### SUPER HIGH-GLOSS LACQUER

|  |                  |
|--|------------------|
| #103 PIANO BLACK                       | w/CHROME DRUM HW |
| #106 ANTIQUE IVORY                     | w/CHROME DRUM HW |
| #110 SEQUOIA RED                       | w/CHROME DRUM HW |
| #113 SHEER BLUE                        | w/CHROME DRUM HW |
| <b>NEW</b> #361 VINTAGE COPPER SPARKLE | w/CHROME DRUM HW |
| #389 MATTE LIQUID AMBER                | w/CHROME DRUM HW |

## FEATURES

- 6 PLY BIRCH/KAPUR SHELLS
- WOOD BASS DRUM HOOPS w/MATCHING FINISH
- RECESSED BD CLAWS w/RUBBER LINING
- REMO SNARE DRUM HEADS
- REMO PINSTRIPE TOM BATTER/CLEAR RESO HEADS
- REMO POWERSTROKE BASS DRUM HEADS
- RL-10/20 SESSION LUGS
- LB/LG-40 MASTERS FLOOR TOM BRACKETS & LEGS
- OPTIMUMT TOM HOLDERS
- BEAUTIFUL SUPER HIGH-GLOSS LACQUER FINISHES
- LIFETIME WARRANTY



## SUGGESTED HARDWARE PACK

**HWP-930** 930 SERIES w/UNILOCK TILTERS ..... **\$770**

# NEW LIMITED EDITION FW WOOD FIBERGLASS

SHELL MATERIAL: 6 PLY 7.5MM POPLAR/KAPUR/FIBERGLASS SHELLS  
FINISHES: HIGH GLOSS AND SATIN LACQUER

## SHELL PACKS

**FW 923XP/C** ..... **\$1,759**

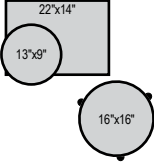

**INCLUDES:**  
**FW 2214BX** 22"x14" BASS  
**FW 1309T** 13"x9" TOM  
**FW 1616F** 16"x16" FLOOR TOM

**FW 943XP/C** ..... **\$1,799**

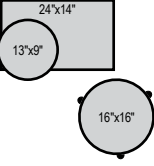

**INCLUDES:**  
**FW 2414BX** 24"x14" BASS  
**FW 1309T** 13"x9" TOM  
**FW 1616T** 16"x16" FLOOR TOM

**FW 903XP/C** ..... **\$1,665**

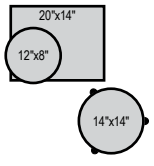

**INCLUDES:**  
**FW 2014BX** 20"x14" BASS  
**FW 1208T** 12"x8" TOM  
**FW 1414F** 14"x14" FLOOR TOM

## COMPONENTS

| TOMS w/OPTIMOUNT |        |          |
|------------------|--------|----------|
| FW 1007T/C*      | 10"x7" | \$400.00 |
| FW 1208T/C*      | 12"x8" | 430.00   |
| FW 1309T/C*      | 13"x9" | 460.00   |

| FLOOR TOMS  |         |          |
|-------------|---------|----------|
| FW 1414F/C* | 14"x14" | \$590.00 |
| FW 1616F/C* | 16"x16" | 660.00   |
| FW 1816F/C* | 18"x16" | 790.00   |

| BASS DRUMS w/o BB-3 BRACKET |         |            |
|-----------------------------|---------|------------|
| FW 2014BX/C*                | 20"x14" | \$1,100.00 |
| FW 2214BX/C*                | 22"x14" | 1,180.00   |
| FW 2414BX/C*                | 24"x14" | 1,260.00   |

\*SPECIAL ORDER - PLEASE ALLOW 3 TO 5 MONTHS FOR DELIVERY

## FINISHES

### PRO LACQUER

|                 |                   |                  |
|-----------------|-------------------|------------------|
| #103            | PIANO BLACK       | W/CHROME DRUM HW |
| #151            | PLATINUM MIST     | W/CHROME DRUM HW |
| #152            | ANTIQUE GOLD      | W/CHROME DRUM HW |
| <i>NEW</i> #327 | SATIN COCOA BURST | W/CHROME DRUM HW |

## FEATURES

- 6 PLY POPLAR/KAPUR/FIBERGLASS SHELLS
- WOOD BASS DRUM HOOPS w/MATCHING FINISH
- RECESSED BD CLAWS w/RUBBER LINING
- REMO SNARE DRUM HEADS
- REMO PINSTRIPE TOM BATTER/CLEAR RESO HEADS
- REMO POWERSTROKE BASS DRUM HEADS (WHITE COATED VENTED FRONT LOGO HEAD)
- RL-10/20 SESSION LUGS
- LB/LG-40 MASTERS FLOOR TOM BRACKETS & LEGS
- OPTIMOUNT TOM HOLDERS
- BEAUTIFUL SUPER HIGH-GLOSS & MATTE LACQUER FINISHES
- LIFETIME WARRANTY



## SUGGESTED HARDWARE PACK

**HWP-930** 930 SERIES w/UNILOCK TILTERS ..... **\$770**

# CRB CRYSTAL BEAT

SHELL MATERIAL: SEAMLESS ACRYLIC SHELLS  
FINISH: CRYSTAL CLEAR

## SHELL PACKS

### CRB 524P/C ..... \$1,799

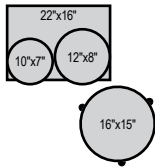

INCLUDES:  
**CRB 2216BX** 22"x16" BASS  
**CRB 1007T** 10"x7" TOM  
**CRB 1208T** 12"x8" TOM  
**CRB 1615F** 16"x15" FLOOR TOM

### CRB 524FP/C ..... \$1,999

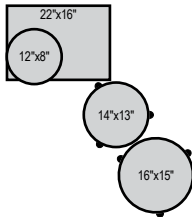

INCLUDES:  
**CRB 2216BX** 22"x16" BASS  
**CRB 1208T** 12"x8" TOM  
**CRB 1413F** 14"x13" FLOOR TOM  
**CRB 1615F** 16"x15" FLOOR TOM

### CRB 525FP/C ..... \$2,165

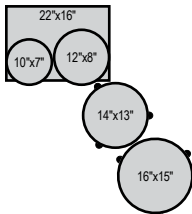

INCLUDES:  
**CRB 2216BX** 22"x16" BASS  
**CRB 1007T** 10"x7" TOM  
**CRB 1208T** 12"x8" TOM  
**CRB 1413F** 14"x13" FLOOR TOM  
**CRB 1615F** 16"x15" FLOOR TOM

### CRB 503P/C ..... \$1,499

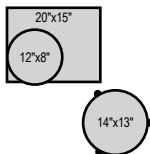

INCLUDES:  
**CRB 2015BX** 20"x15" BASS  
**CRB 1208T** 12"x8" TOM  
**CRB 1413F** 14"x13" FLOOR TOM

## COMPONENTS

### ACRYLIC SHELL FREE FLOATING SNARE DRUMS

|             |          |          |
|-------------|----------|----------|
| CRB 1435/C* | 14"x3.5" | TBA      |
| CRB 1450/C  | 14"x5"   | \$799.00 |
| CRB 1465/C  | 14"x6.5" | 829.00   |
| CRB 1480/C* | 14"x8"   | TBA      |

\*SPECIAL ORDER ONLY - PLEASE ALLOW 3 TO 5 MONTHS FOR DELIVERY.

### ACRYLIC SHELLS FOR FREE FLOATING SNARE DRUM CHASSIS

\*FITS ALL CURRENT AND PAST MODELS

|             | Drum Size |          |
|-------------|-----------|----------|
| CRB 1435SO* | 14"x3.5"  | TBA      |
| CRB 1450SO  | 14"x5"    | \$180.00 |
| CRB 1465SO  | 14"x6.5"  | 199.00   |
| CRB 1480SO* | 14"x8"    | TBA      |

\*SPECIAL ORDER ONLY - PLEASE ALLOW 3 TO 5 MONTHS FOR DELIVERY.

### TOMS w/OPTIMOUNT

|             |        |          |
|-------------|--------|----------|
| CRB 0807T/C | 8"x7"  | \$295.00 |
| CRB 1007T/C | 10"x7" | 325.00   |
| CRB 1208T/C | 12"x8" | 375.00   |
| CRB 1309T/C | 13"x9" | 395.00   |

### FLOOR TOMS

|             |         |          |
|-------------|---------|----------|
| CRB 1413F/C | 14"x13" | \$420.00 |
| CRB 1615F/C | 16"x15" | 485.00   |
| CRB 1816F/C | 18"x16" | 510.00   |

### BASS DRUMS w/O BB-3

|              |         |          |
|--------------|---------|----------|
| CRB 2015BX/C | 20"x15" | \$770.00 |
| CRB 2216BX/C | 22"x16" | 810.00   |

## FINISHES

### CRYSTAL CLEAR

|      |                 |                  |
|------|-----------------|------------------|
| #730 | ULTRA CLEAR     | w/CHROME DRUM HW |
| #731 | RUBY RED        | w/CHROME DRUM HW |
| #732 | TANGERINE GLASS | w/CHROME DRUM HW |

## FEATURES

- SEAMLESS ACRYLIC SHELLS
- 6MM TOM AND SNARE DRUM SHELLS
- 7MM BASS DRUM SHELLS
- ACRYLIC BASS DRUM HOOPS w/MATCHING FINISH
- RECESSED BASS DRUM CLAWS w/RUBBER LINING
- 1.2MM TRIPLE FLANGED HOOPS
- 2 PLY CLEAR TOM BATTER HEADS
- 1 PLY CLEAR TOM RESO HEADS
- 1 PLY CLEAR BASS DRUM HEADS w/SELF-MUFFLING RING
- OPTIMOUNT SUSPENSION SYSTEM
- AIR SUSPENSION FLOOR TOM FEET
- MOLDED RUBBER GASKETS
- TELESCOPING SPURS w/RUBBER OR SPIKE TIP
- BEAUTIFUL CRYSTAL CLEAR FINISHES
- LIMITED 2 YEAR WARRANTY

## SUGGESTED HARDWARE PACK

**HWP-930** 930 SERIES w/UNILOCK TILTERS ..... \$770

# VBL VISION BIRCH LACQUER

SHELL MATERIAL: 6 PLY 7.5MM 100% BIRCH  
FINISH: SUPER HIGH GLOSS LACQUER

## SETS & SHELL PACKS

**VBL 925/C** SHELL PACK & 930 HARDWARE ..... **\$1,899**  
**VBL 925P/C** SHELL PACK ..... **1,359**

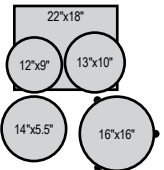

|                    |          |              |                      |
|--------------------|----------|--------------|----------------------|
| <b>SHELL PACK:</b> |          |              | <b>930 HARDWARE:</b> |
| VBL 2218B/C        | 22"x18"  | BASS         | BC-930 BOOM STAND    |
| VBL 1209T/C        | 12"x9"   | TOM          | C-930 CYMBAL STAND   |
| VBL 1310T/C        | 13"x10"  | TOM          | H-930 HI-HAT STAND   |
| VBL 1616F/C        | 16"x16"  | FLOOR TOM    | S-930 SNARE STAND    |
| SS 1455S/C         | 14"x5.5" | SENSITONE    | P-930 PEDAL          |
| TH-900I            | UNI-LOCK | TOM ARMS (2) |                      |

**VBL 925S/C** SHELL PACK & 930 HARDWARE ..... **\$1,899**  
**VBL 925SP/C** SHELL PACK ..... **1,359**

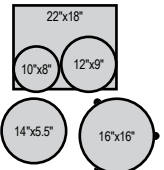

|                    |          |              |                      |
|--------------------|----------|--------------|----------------------|
| <b>SHELL PACK:</b> |          |              | <b>930 HARDWARE:</b> |
| VBL 2218B/C        | 22"x18"  | BASS         | BC-930 BOOM STAND    |
| VBL 1008T/C        | 10"x8"   | TOM          | C-930 CYMBAL STAND   |
| VBL 1209T/C        | 12"x9"   | TOM          | H-930 HI-HAT STAND   |
| VBL 1616F/C        | 16"x16"  | FLOOR TOM    | S-930 SNARE STAND    |
| SS 1455S/C         | 14"x5.5" | SENSITONE    | P-930 PEDAL          |
| TH-900I            | UNI-LOCK | TOM ARMS (2) |                      |

**VBL 905/C** SHELL PACK & 930 HARDWARE ..... **\$1,899**  
**VBL 905P/C** SHELL PACK ..... **1,359**

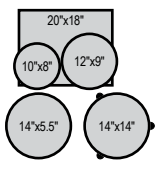

|                    |          |              |                      |
|--------------------|----------|--------------|----------------------|
| <b>SHELL PACK:</b> |          |              | <b>930 HARDWARE:</b> |
| VBL 2018B/C        | 20"x18"  | BASS         | BC-930 BOOM STAND    |
| VBL 1008T/C        | 10"x8"   | TOM          | C-930 CYMBAL STAND   |
| VBL 1209T/C        | 12"x9"   | TOM          | H-930 HI-HAT STAND   |
| VBL 1414F/C        | 14"x14"  | FLOOR TOM    | S-930 SNARE STAND    |
| SS 1455S/C         | 14"x5.5" | SENSITONE    | P-930 PEDAL          |
| TH-900I            | UNI-LOCK | TOM ARMS (2) |                      |

## SUGGESTED HARDWARE PACK

**HWP-930** 930 SERIES w/UNILOCK TILTERS ..... **\$770**

## COMPONENTS

| SENSITONE SNARE DRUM w/CHROME FINISH |          |          |
|--------------------------------------|----------|----------|
| SS 1455S/C                           | 14"x5.5" | \$250.00 |

| TOMS w/I.S.S. |         |          |
|---------------|---------|----------|
| VBL 0807T/C   | 8"x7"   | \$250.00 |
| VBL 1008T/C   | 10"x8"  | 265.00   |
| VBL 1209T/C   | 12"x9"  | 280.00   |
| VBL 1310T/C   | 13"x10" | 300.00   |
| VBL 1411T/C   | 14"x11" | 330.00   |
| VBL 1613T/C   | 16"x13" | 415.00   |

| FLOOR TOMS  |         |          |
|-------------|---------|----------|
| VBL 1414F/C | 14"x14" | \$380.00 |
| VBL 1616F/C | 16"x16" | 465.00   |
| VBL 1816F/C | 18"x16" | 530.00   |

| BASS DRUMS w/BB-300 BRACKET |         |          |
|-----------------------------|---------|----------|
| VBL 2018B/C                 | 20"x18" | \$780.00 |
| VBL 2218B/C                 | 22"x18" | 830.00   |
| VBL 2418B/C                 | 24"x18" | 915.00   |

## FINISHES

| HIGH GLOSS LACQUER       |                        |  |
|--------------------------|------------------------|--|
| #230 CLEAR BIRCH         | w/CHROME DRUM HARDWARE |  |
| #232 RUBY FADE           | w/CHROME DRUM HARDWARE |  |
| #239 GRAPHITE            | w/CHROME DRUM HARDWARE |  |
| #243 PRUSSIAN BLUE       | w/CHROME DRUM HARDWARE |  |
| #244 NATURAL BLACK BURST | w/CHROME DRUM HARDWARE |  |

## FEATURES

- 6 PLY 7.5MM 100% BIRCH SHELLS
- STEEL SENSITONE SNARE DRUM w/CHROME FINISH
- WOOD BASS DRUM HOOPS w/MATCHING FINISH
- 930 SERIES HARDWARE
- REMO SNARE DRUM HEADS
- REMO PINSTRIPE TOM BATTER/CLEAR RESO HEADS
- REMO POWERSTROKE BASS DRUM HEADS
- REFERENCE-LOOK BRIDGE LUGS w/RUBBER GASKETS
- REFERENCE-LOOK FLOOR TOM LEG BRACKETS & LEGS
- REFERENCE-LOOK RECESSED BD CLAWS w/RUBBER LINING
- BRIDGE-TYPE BASS BRACKET
- 900 SERIES UNI-LOCK (INFINITELY ADJUSTABLE) TOM HOLDERS
- I.S.S. TOM MOUNTING SYSTEM
- BEAUTIFUL SUPER HIGH-GLOSS LACQUER FINISHES
- LIFETIME WARRANTY



# EXL EXPORT LACQUER

SHELL MATERIAL: 6 PLY 7.5MM POPLAR / ASIAN MAHOGANY  
FINISH: HIGH GLOSS LACQUER

## SETS & ADD-ON PACKS

NEW

**EXL 725/C** 5 PC. SET w/830 HW ..... **\$1,249**

**EXL 725P/C** SHELL PACK ..... **799**

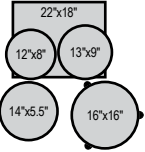

**DRUMS**  
EXL 2218B/C 22"x18" BASS  
EXL 1208T/C 12"x8" TOM  
EXL 1309T/C 13"x9" TOM  
EXL 1616F/C 16"x16" FLOOR TOM  
EXL 1455S/C 14"x5.5" SNARE  
TH-701 GEAR TOM ARMS x 2

**830 HARDWARE**  
BC-830 BOOM STAND  
C-830 CYMBAL STAND  
H-830 HI-HAT STAND  
S-830 SNARE STAND  
P-930 PEDAL

NEW

**EXL 725/C** 5 PC. SET w/830 HW ..... **\$1,249**

**EXL 725SP/C** SHELL PACK ..... **799**

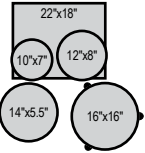

**DRUMS**  
EXL 2218B/C 22"x18" BASS  
EXL 1007T/C 10"x7" TOM  
EXL 1208T/C 12"x8" TOM  
EXL 1616F/C 16"x16" FLOOR TOM  
EXL 1455S/C 14"x5.5" SNARE  
TH-701 GEAR TOM ARMS x 2

**830 HARDWARE**  
BC-830 BOOM STAND  
C-830 CYMBAL STAND  
H-830 HI-HAT STAND  
S-830 SNARE STAND  
P-930 PEDAL

NEW

**EXL 705/C** 5 PC. SET w/830 HW ..... **\$1,249**

**EXL 705P/C** SHELL PACK ..... **799**

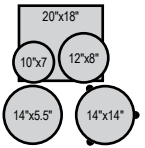

**DRUMS**  
EXL 2018B/C 20"x18" BASS  
EXL 1007T/C 10"x7" TOM  
EXL 1208T/C 12"x8" TOM  
EXL 1414F/C 14"x14" FLOOR TOM  
EXL 1455S/C 14"x5.5" SNARE  
TH-701 GEAR TOM ARMS x 2

**830 HARDWARE**  
BC-830 BOOM STAND  
C-830 CYMBAL STAND  
H-830 HI-HAT STAND  
S-830 SNARE STAND  
P-930 PEDAL

## ADD-ON PACKS

**EXL 8P/C** EXL-0807T/C 8"x7" w/TH-70S & ADP-20 ..... **\$180**

**EXL 10P/C** EXL-1007T/C 10"x7" w/TH-70S & ADP-20 ..... **200**

## COMPONENTS

| SNARE DRUM  |          |          |
|-------------|----------|----------|
| EXL 1455S/C | 14"x5.5" | \$200.00 |

| TOMS w/I.S.S. |        |          |
|---------------|--------|----------|
| EXL 1208T/C   | 12"x8" | \$180.00 |
| EXL 1309T/C   | 13"x9" | 200.00   |

| FLOOR TOMS  |         |          |
|-------------|---------|----------|
| EXL 1414F/C | 14"x14" | \$265.00 |
| EXL 1616F/C | 16"x16" | 300.00   |
| EXL 1816F/C | 18"x16" | 350.00   |

| BASS DRUMS w/BB-70 |         |          |
|--------------------|---------|----------|
| EXL 2018B/C        | 20"x18" | \$465.00 |
| EXL 2218B/C        | 22"x18" | 500.00   |
| EXL 2418B/C        | 24"x18" | 530.00   |

## FINISHES

| HIGH GLOSS LACQUER FINISHES |  |                  |
|-----------------------------|--|------------------|
| #246 NATURAL CHERRY         |  | w/CHROME DRUM HW |
| #248 BLACK SMOKE            |  | w/CHROME DRUM HW |
| #249 HONEY AMBER            |  | w/CHROME DRUM HW |
| NEW #255 NIGHTSHADE LACQUER |  | w/CHROME DRUM HW |

## FEATURES

- 6 PLY 7.5MM POPLAR/ASIAN MAHOGANY SHELLS
- OPTI-LOC SUSPENSION SYSTEM
- REMO SNARE DRUM HEADS
- REMO CLEAR TOM HEADS
- REMO POWERSTROKE BASS DRUM HEADS
- MATCHING WOOD SNARE DRUM
- WOOD BASS DRUM HOOPS
- LIFETIME WARRANTY



# EXX EXPORT

SHELL MATERIAL: 6 PLY 7.5 POPLAR/ASIAN MAHOGANY  
FINISH: PEARL EXCLUSIVE COVERED FINISHES

## SETS

### EXX 725/C 5 PC. SET w/830 HARDWARE ..... \$1,099

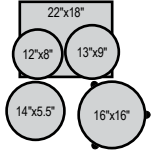

|               |                   |                      |              |
|---------------|-------------------|----------------------|--------------|
| <b>DRUMS:</b> |                   | <b>830 HARDWARE:</b> |              |
| EXX 2218B/C   | 22"x18" BASS      | BC-830               | BOOM STAND   |
| EXX 1208T/C   | 12"x8" TOM        | C-830                | CYMBAL STAND |
| EXX 1309T/C   | 13"x9" TOM        | H-830                | HI-HAT STAND |
| EXX 1616F/C   | 16"x16" FLOOR TOM | S-830                | SNARE STAND  |
| EXX 1455S/C   | 14"x5.5" SNARE    | P-930                | PEDAL        |
| TH-701        | GEAR TOM ARMS x 2 |                      |              |

### EXX 725S/C 5 PC. SET w/830 HARDWARE ..... \$1,099

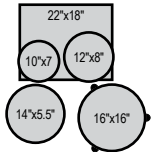

|               |                   |                      |              |
|---------------|-------------------|----------------------|--------------|
| <b>DRUMS:</b> |                   | <b>830 HARDWARE:</b> |              |
| EXX 2218B/C   | 22"x18" BASS      | BC-830               | BOOM STAND   |
| EXX 1007T/C   | 10"x7" TOM        | C-830                | CYMBAL STAND |
| EXX 1208T/C   | 12"x8" TOM        | H-830                | HI-HAT STAND |
| EXX 1616F/C   | 16"x16" FLOOR TOM | S-830                | SNARE STAND  |
| EXX 1455S/C   | 14"x5.5" SNARE    | P-930                | PEDAL        |
| TH-701        | GEAR TOM ARMS x 2 |                      |              |

### EXX 705/C 5 PC. SET w/830 HARDWARE ..... \$1,099

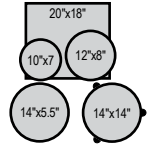

|               |                   |                      |              |
|---------------|-------------------|----------------------|--------------|
| <b>DRUMS:</b> |                   | <b>830 HARDWARE:</b> |              |
| EXX 2018B/C   | 20"x18" BASS      | BC-830               | BOOM STAND   |
| EXX 1007T/C   | 10"x7" TOM        | C-830                | CYMBAL STAND |
| EXX 1208T/C   | 12"x8" TOM        | H-830                | HI-HAT STAND |
| EXX 1414F/C   | 14"x14" FLOOR TOM | S-830                | SNARE STAND  |
| EXX 1455S/C   | 14"x5.5" SNARE    | P-930                | PEDAL        |
| TH-701        | GEAR TOM ARMS x 2 |                      |              |

## COMPONENTS

| SNARE DRUM  |          |          |
|-------------|----------|----------|
| EXX 1455S/C | 14"x5.5" | \$180.00 |

| TOMS w/OPTI-LOC |        |          |
|-----------------|--------|----------|
| EXX 1208T/C     | 12"x8" | \$170.00 |
| EXX 1309T/C     | 13"x9" | 180.00   |

| FLOOR TOMS  |         |          |
|-------------|---------|----------|
| EXX 1414F/C | 14"x14" | \$220.00 |
| EXX 1616F/C | 16"x16" | 250.00   |
| EXX 1816F/C | 18"x16" | 280.00   |

| BASS DRUMS w/BB-70 |         |          |
|--------------------|---------|----------|
| EXX 2018B/C        | 20"x18" | \$420.00 |
| EXX 2218B/C        | 22"x18" | 450.00   |
| EXX 2418B/C        | 24"x18" | 480.00   |

## FINISHES

| COVERED         |                       |                  |
|-----------------|-----------------------|------------------|
| #21             | SMOKEY CHROME         | w/CHROME DRUM HW |
| #31             | JET BLACK             | w/CHROME DRUM HW |
| #33             | PURE WHITE            | w/CHROME DRUM HW |
| #91             | RED WINE              | w/CHROME DRUM HW |
| #702            | ELECTRIC BLUE SPARKLE | w/CHROME DRUM HW |
| <i>NEW</i> #708 | GRINDSTONE SPARKLE    | w/CHROME DRUM HW |

## FEATURES

- 6 PLY 7.5MM POPLAR / ASIAN MAHOGANY SHELLS
- OPTI-LOC SUSPENSION TOM HOLDER
- MATCHING WOOD SNARE DRUM
- WOOD BASS DRUM HOOPS
- REMO SNARE DRUM HEADS
- REMO CLEAR TOM HEADS
- REMO POWERSTROKE BASS DRUM HEADS
- LIFETIME WARRANTY



## ADD-ON PACKS

|                  |  |              |
|------------------|--|--------------|
| <b>EXX 8P/C</b>  | EXX-0807T/C 8"x7" w/TH-70S & ADP-20 .....  | <b>\$170</b> |
| <b>EXX 10P/C</b> | EXX-1007T/C 10"x7" w/TH-70S & ADP-20 ..... | <b>180</b>   |

# RS ROADSHOW

SHELL MATERIAL: 9 PLY 7MM POPLAR  
FINISH: PEARL EXCLUSIVE COVERED FINISHES

## COMPLETE SETS w/CYMBALS

## FINISHES

### EXCLUSIVE COVERED FINISHES

|                        |                  |
|------------------------|------------------|
| #31 JET BLACK          | w/CHROME DRUM HW |
| #91 WINE RED           | w/CHROME DRUM HW |
| #706 CHARCOAL METALLIC | w/CHROME DRUM HW |
| #707 BRONZE METALLIC   | w/CHROME DRUM HW |

## FEATURES

- 9 PLY 7MM POPLAR SHELLS
- DOUBLE-BRACED HARDWARE
- 1.2MM TRIPLE FLANGED HOOPS
- 1 PLY COATED SNARE DRUM HEAD
- 1 PLY CLEAR TOM HEADS
- 1 PLY CLEAR BASS DRUM HEADS w/SELF-MUFFLING RING
- MATCHING WOOD SNARE DRUM
- 16" CRASH-RIDE CYMBAL
- 14" HYBRID HI-HATS
- MAPLE DRUM STICKS (2 PR)
- PROFESSIONAL STICK BAG
- PEARL DRUM POSTER
- LIMITED 2 YEAR WARRANTY

### RS 525SC/C

5 PC. SET ..... **\$749**

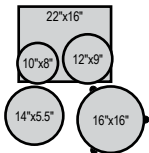

| DRUMS      |                   | HARDWARE & CYMBALS   |  |
|------------|-------------------|----------------------|--|
| RS 2216B/C | 22"x16" BASS      | CYMBAL STAND         |  |
| RS 1008T/C | 10"x8" TOM        | HI-HAT STAND         |  |
| RS 1209T/C | 12"x9" TOM        | SNARE STAND          |  |
| RS 1616F/C | 16"x16" FLOOR TOM | PEDAL                |  |
| RS 1455S/C | 14"x5.5" SNARE    | THRONE               |  |
|            |                   | TOM HOLDERS x 2      |  |
|            |                   | 16" BRASS CRASH-RIDE |  |
|            |                   | 14" HYBRID HI-HATS   |  |
|            |                   | DRUM STICKS (2PR)    |  |
|            |                   | STICK BAG            |  |

### RS 525WFC/C

5 PC. SET ..... **\$839**

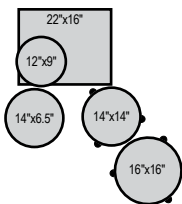

| DRUMS      |                   | HARDWARE & CYMBALS   |  |
|------------|-------------------|----------------------|--|
| RS 2216B/C | 22"x16" BASS      | CYMBAL STAND         |  |
| RS 1209T/C | 12"x9" TOM        | HI-HAT STAND         |  |
| RS 1414F/C | 14"x14" FLOOR TOM | SNARE STAND x 2      |  |
| RS 1616F/C | 16"x16" FLOOR TOM | PEDAL                |  |
| RS 1465S/C | 14"x6.5" SNARE    | THRONE               |  |
|            |                   | 16" BRASS CRASH-RIDE |  |
|            |                   | 14" HYBRID HI-HATS   |  |
|            |                   | DRUM STICKS (2PR)    |  |
|            |                   | STICK BAG            |  |

### RS 505C/C

5 PC. SET ..... **\$749**

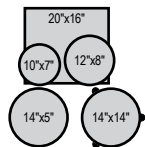

| DRUMS      |                   | HARDWARE & CYMBALS   |  |
|------------|-------------------|----------------------|--|
| RS 2016B/C | 20"x16" BASS      | CYMBAL STAND         |  |
| RS 1007T/C | 10"x7" TOM        | HI-HAT STAND         |  |
| RS 1208T/C | 12"x8" TOM        | SNARE STAND          |  |
| RS 1414F/C | 14"x14" FLOOR TOM | PEDAL                |  |
| RS 1450S/C | 14"x5" SNARE      | THRONE               |  |
|            |                   | TOM HOLDERS x 2      |  |
|            |                   | 16" BRASS CRASH-RIDE |  |
|            |                   | 14" HYBRID HI-HATS   |  |
|            |                   | DRUM STICKS (2PR)    |  |
|            |                   | STICK BAG            |  |

### RS 584C/C

4 PC. SET ..... **\$649**

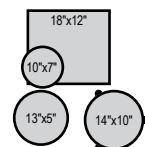

| DRUMS      |                   | HARDWARE & CYMBALS   |  |
|------------|-------------------|----------------------|--|
| RS 1812B/C | 18"x12" BASS      | BOOM CYMBAL HOLDER   |  |
| RS 1007T/C | 10"x7" TOM        | HI-HAT STAND         |  |
| RS 1410F/C | 14"x14" FLOOR TOM | SNARE STAND          |  |
| RS 1350S/C | 13"x5" SNARE      | PEDAL                |  |
|            |                   | THRONE               |  |
|            |                   | TOM HOLDER           |  |
|            |                   | 16" BRASS CRASH-RIDE |  |
|            |                   | 14" HYBRID HI-HATS   |  |
|            |                   | DRUM STICKS (2PR)    |  |
|            |                   | STICK BAG            |  |

## RT RHYTHM TRAVELER

**RT 705HBCMH 31** ..... **\$832.00**

- 20"x8" BASS
- 10"x5" TOM
- 12"x5" TOM
- 14"x5" TOM
- 13"x5" SNARE
- 16" BRASS CYMBAL
- 13" BRASS HI-HATS (PR.)
- PLASTIC RIDE CYMBAL
- 13" PLASTIC HI-HATS (PR.)
- CYMBAL PADS x 2 / HH PAD x 1
- CYMBAL STAND
- SNARE STAND
- HI-HAT STAND
- PEDAL
- TOM ARMS
- SHORT TOM ARM w/CLAMP
- PLASTIC & MESH HEADS
- #31 JET BLACK FINISH



## RHYTHM TRAVELER POD

**RT 565** ..... **\$832.00**

- 16"x13" BASS
- 8"x3.5" TOM
- 10"x4" TOM
- 12"x5" TOM
- 12"x5" SNARE
- 13" BRASS CYMBAL
- 13" BRASS HI-HATS (PR.)
- MESH HEADS
- 2-PLY PROTONE HEADS
- CYMBAL HOLDER
- HI-HAT STAND
- PEDAL
- TOM ARMS
- #31 JET BLACK FINISH
- #33 PURE WHITE FINISH
- #91 RED WINE FINISH



## ROCKET TOMS ALUMINUM SHELLS

|          |                   |          |
|----------|-------------------|----------|
| AL-0612  | 6"x12"            | \$179.00 |
| AL-0615  | 6"x15"            | 209.00   |
| AL-0618  | 6"x18"            | 219.00   |
| AL-0621  | 6"x21"            | 239.00   |
| ALX-1215 | 12" & 15" w/T-890 | 599.00   |
| ALX-1821 | 18" & 21" w/T-890 | 639.00   |

COLORS: #103 PIANO BLACK & #109 ARCTIC WHITE





# ePRO POWERED BY EXPORT

THE REAL LOOK, THE REAL FEEL, AND THE REAL SOUNDS OF REAL DRUMS



## EPEXX SETS

## FINISHES

HIGH GLOSS COVERING

- #21 SMOKEY CHROME
- #31 JET BLACK
- #33 PURE WHITE
- #91 RED WINE
- #702 ELECTRIC BLUE SPARKLE
- NEW** #708 GRINDSTONE SPARKLE

ALL DRUMS FEATURE CHROME HARDWARE



### EPEXX 725/C

5 PC. SET w/ePRO CONVERSION KIT, 830 HARDWARE & PLASTIC CYMBALS ..... **\$4,608**

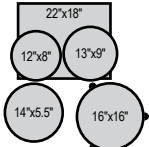

THRONE NOT INCLUDED

#### DRUMS:

- EXX 2218B/C 22"x18" BASS
- EXX 1208T/C 12"x8" TOM
- EXX 1309T/C 13"x9" TOM
- EXX 1616F/C 16"x16" FLOOR TOM
- EXX 1455S/C 14"x5.5" SNARE

#### 830 HARDWARE:

- BC-830 BOOM STAND
- C-830 CYMBAL STAND
- H-830 HI-HAT STAND
- S-830 SNARE STAND
- P-930 PEDAL
- TH-701 TOM ARMS x 2
- UX-80 UNIVERSAL CLAMP x 1
- AX-25L ADAPTER W/REVOLVING CLAMPS

#### TRU-TRAC ELECTRONIC DRUMHEADS:

- TTP-B BASS
- TTP-12 TOM
- TTP-13 TOM
- TTP-16 FLOOR TOM
- TTP-14 SNARE

#### ELECTRONICS:

- RBM-20MUL R.E.D. BOX DRUM MODULE
- RDMM R.E.D. BOX MOUNTING BRACKET
- EPS-1UL R.E.D. BOX POWER SUPPLY
- EHH-2 TRU-TRAC HI-HAT CYMBALS
- EP-02P TRU-TRAC PLASTIC CYMBAL SET
- CH-10 CABLE BUNDLE
- NDA-1 JUNCTION BOX X 5

### EPEXX 725S/C

5 PC. SET w/ePRO CONVERSION KIT, 830 HARDWARE & PLASTIC CYMBALS ..... **\$4,608**

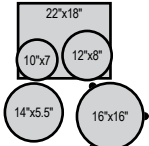

THRONE NOT INCLUDED

#### DRUMS:

- EXX 2218B/C 22"x18" BASS
- EXX 1007T/C 10"x7" TOM
- EXX 1208T/C 12"x8" TOM
- EXX 1616F/C 16"x16" FLOOR TOM
- EXX 1455S/C 14"x5.5" SNARE

#### 830 HARDWARE:

- BC-830 BOOM STAND
- C-830 CYMBAL STAND
- H-830 HI-HAT STAND
- S-830 SNARE STAND
- P-930 PEDAL
- TH-701 TOM ARMS x 2
- UX-80 UNIVERSAL CLAMP x 1
- AX-25L ADAPTER W/REVOLVING CLAMPS

#### TRU-TRAC ELECTRONIC DRUMHEADS:

- TTP-B BASS
- TTP-10 TOM
- TTP-12 TOM
- TTP-16 FLOOR TOM
- TTP-14 SNARE

#### ELECTRONICS:

- RBM-20MUL R.E.D. BOX DRUM MODULE
- RDMM R.E.D. BOX MOUNTING BRACKET
- EPS-1UL R.E.D. BOX POWER SUPPLY
- EHH-2 TRU-TRAC HI-HAT CYMBALS
- EP-02P TRU-TRAC PLASTIC CYMBAL SET
- CH-10 CABLE BUNDLE
- NDA-1 JUNCTION BOX X 5

## EPEXL SETS

## FINISHES

HIGH GLOSS LACQUER

- #246 NATURAL CHERRY
- #248 BLACK SMOKE
- #249 HONEY AMBER
- NEW** #255 NIGHTSHADE LACQUER

ALL DRUMS FEATURE CHROME HARDWARE



### EPEXL 725/C

5 PC. SET w/ePRO CONVERSION KIT, 830 HARDWARE & PLASTIC CYMBALS ..... **\$4,758**

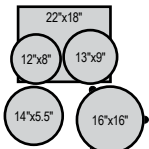

THRONE NOT INCLUDED

#### DRUMS:

- EXL 2218B/C 22"x18" BASS
- EXL 1208T/C 12"x8" TOM
- EXL 1309T/C 13"x9" TOM
- EXL 1616F/C 16"x16" FLOOR TOM
- EXL 1455S/C 14"x5.5" SNARE

#### 830 HARDWARE:

- BC-830 BOOM STAND
- C-830 CYMBAL STAND
- H-830 HI-HAT STAND
- S-830 SNARE STAND
- P-930 PEDAL
- TH-701 TOM ARMS x 2
- UX-80 UNIVERSAL CLAMP x 1
- AX-25L ADAPTER W/REVOLVING CLAMPS

#### TRU-TRAC ELECTRONIC DRUMHEADS:

- TTP-B BASS
- TTP-12 TOM
- TTP-13 TOM
- TTP-16 FLOOR TOM
- TTP-14 SNARE

#### ELECTRONICS:

- RBM-20MUL R.E.D. BOX DRUM MODULE
- RDMM R.E.D. BOX MOUNTING BRACKET
- EPS-1UL R.E.D. BOX POWER SUPPLY
- EHH-2 TRU-TRAC HI-HAT CYMBALS
- EP-02P TRU-TRAC PLASTIC CYMBAL SET
- CH-10 CABLE BUNDLE
- NDA-1 JUNCTION BOX X 5

### EPEXL 725S/C

5 PC. SET w/ePRO CONVERSION KIT, 830 HARDWARE & PLASTIC CYMBALS ..... **\$4,758**

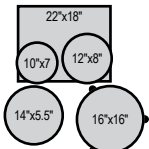

THRONE NOT INCLUDED

#### DRUMS:

- EXL 2218B/C 22"x18" BASS
- EXL 1007T/C 10"x7" TOM
- EXL 1208T/C 12"x8" TOM
- EXL 1616F/C 16"x16" FLOOR TOM
- EXL 1455S/C 14"x5.5" SNARE

#### 830 HARDWARE:

- BC-830 BOOM STAND
- C-830 CYMBAL STAND
- H-830 HI-HAT STAND
- S-830 SNARE STAND
- P-930 PEDAL
- TH-701 TOM ARMS x 2
- UX-80 UNIVERSAL CLAMP x 1
- AX-25L ADAPTER W/REVOLVING CLAMPS

#### TRU-TRAC ELECTRONIC DRUMHEADS:

- TTP-B BASS
- TTP-10 TOM
- TTP-12 TOM
- TTP-16 FLOOR TOM
- TTP-14 SNARE

#### ELECTRONICS:

- RBM-20MUL R.E.D. BOX DRUM MODULE
- RDMM R.E.D. BOX MOUNTING BRACKET
- EPS-1UL R.E.D. BOX POWER SUPPLY
- EHH-2 TRU-TRAC HI-HAT CYMBALS
- EP-02P TRU-TRAC PLASTIC CYMBAL SET
- CH-10 CABLE BUNDLE
- NDA-1 JUNCTION BOX X 5

# EPRO COCKTAIL KIT, TRU-TRAC CONVERSION KITS AND ACCESSORIES

## NEW EPRO COCKTAIL KIT



### EPCTK1424/SC ..... \$3,299

- THE FIRST MULTI-ZONE ELECTRONIC COCKTAIL KIT
- INCLUDES 7 PROGRAMMABLE TRIGGERS w/ACCESS TO 1000 SOUNDS
- DUAL LAYERING CAPABILITY
- COMPLETE WITH ELIMINATOR CHAIN PEDAL
- CUSTOM WRAPPED DELMAR FINISHES

### INCLUDES

- RBM20MUL R.E.D. BOX MODULE
- RDMM R.E.D. BOX MOUNTING BRK.
- DB25 AUDIO HARNESS x 2
- EPC14T 14" PLASTIC 3-ZONE RIDE CYMBAL
- TTPBD TRU-TRAC BASS DRUM PAD
- TTP10 10" TRU-TRAC PAD
- TTP14 14" TRU-TRAC PAD
- UX80 UNIVERSAL CLAMP x 2
- UX80L UNIVERSAL CLAMP
- TH930S TOM HOLDER
- P2002C ELIMINATOR CHAIN PEDAL
- PS85 PEDAL STABILIZER
- BC-830 BOOM CYMBAL STAND

## TRU-TRAC PACK FULL CONVERSION KITS



### WITH PLASTIC CYMBALS

### EPADRBMP ..... \$3,509

12"/13"/14"/16"/BASS TRU-TRAC HEADS

### EPADRBMSP ..... \$3,509

10"/12"/14"/16"/BASS TRU-TRAC HEADS

### EACH KIT INCLUDES

- RBM20MUL R.E.D. BOX MODULE
- RDMM R.E.D. BOX MOUNTING BRK.
- CH10 CABLE BUNDLE
- AX25L MULTI-CLAMP
- EP02P TRU-TRAC PLASTIC CYMBAL SET
- EHH2 TRU-TRAC PLASTIC HI-HAT CYMBALS (PR)
- NDA-1 NO DRILL ADAPTER x 5
- 52MM TENSION RODS x 30
- 63MM TENSION RODS x 30
- NP485 VELCRO TAPE x 10
- BDMTP HOLE POSITION TEMPLATE
- BDPTP PAPER RULER
- HPC6 HOLE PUNCH
- BDC FOAM BASS DRUM CUSHION

## TRU-TRAC ELECTRONIC DRUMHEAD CONVERSION KITS



### TRU-TRAC ELECTRONIC DRUMHEADS

### EPAD-25 ..... \$1,749

12"/13"/14"/16"/BASS TRU-TRAC HEADS

### EPADRBMSP ..... \$1,749

10"/12"/14"/16"/BASS TRU-TRAC HEADS

### EACH KIT INCLUDES

- CABLES
- NO DRILL ADAPTERS
- TENSION RODS
- TEMPLATES
- TRU-TRAC PADS

## TRU-TRAC HI-HAT



### EHH-2 ..... \$199

TRU-TRAC HI-HATS MOUNT TO VIRTUALLY ANY HI-HAT STAND FOR A NATURAL PLAYING EXPERIENCE. WHEN COMBINED WITH THE R.E.D. BOX MODULE, IT PRODUCES SOUNDS FROM OPEN TO CLOSED, HALF OPEN AND THREE QUARTER POSITIONS PLUS CHICK AND SPLASH. IT'S THE PERFECT UPGRADE TO E-PRO LIVE AND TRU-TRAC PAD CONVERSION KITS.  
SOFTWARE UPDATE REQUIRED - AVAILABLE FREE AT REDBOXSOUNDSHOP.COM

### INCLUDES

- TOP AND BOTTOM CYMBALS
- FSR SENSING UNIT
- SPRING
- SOFTWARE UPDATE

## TRU-TRAC COMPONENTS

|           |   |          |
|-----------|---|----------|
| TTP-B     | BASS TRU-TRAC ELECTRONIC DRUMHEAD - FOR ALL BASS DRUM SIZES ..... | \$249.00 |
| TTP-10    | 10" TRU-TRAC ELECTRONIC DRUMHEAD - DUAL ZONE .....                | 319.00   |
| TTP-12    | 12" TRU-TRAC ELECTRONIC DRUMHEAD - DUAL ZONE .....                | 369.00   |
| TTP-13    | 13" TRU-TRAC ELECTRONIC DRUMHEAD - DUAL ZONE .....                | 379.00   |
| TTP-14    | 14" TRU-TRAC ELECTRONIC DRUMHEAD - DUAL ZONE .....                | 399.00   |
| TTP-16    | 16" TRU-TRAC ELECTRONIC DRUMHEAD - DUAL ZONE .....                | 479.00   |
| EP02P     | PLASTIC CYMBAL SET: EPC-14T 14" RIDE, EPC-12D 12" CRASH .....     | 279.00   |
| RBM-20MUL | R.E.D. BOX MODULE .....   | 999.00   |

## ELECTRONIC ACCESSORIES

|         |  |          |
|---------|--|----------|
| THMP-1  | THRONE THUMPER - FEEL THE BEAT THROUGH YOUR THRONE, 200 WATT BASH AMPLIFIER INCLUDED ..... | \$499.00 |
| PDM-250 | PRECISION DRUM MONITORS - REFERENCE HEADPHONES .....                                       | 299.00   |
| DR-2000 | DRUMOMETER MODEL II - DEVELOPS SPEED, ACCURACY AND TECHNIQUE .....                         | 199.99   |
| TB-001  | TUNE-BOT - FAST, ACCURATE AND EFFECTIVE ACOUSTIC DRUM TUNER .....                          | 149.95   |
| RDMM    | R.E.D. BOX MODULE MOUNT - WITH 7/8" DIAMETER POST.....                                     | 10.00    |

# SNARE DRUMS

## TASK-SPECIFIC FREE FLOATING SNARE DRUMS

|            |          |  |          |
|------------|----------|--|----------|
| FTSS-1435  | 14"x3.5" | STAINLESS STEEL - 1MM, DIE CAST HOOPS, SS TENSION RODS, SR-160F STRAINER, BRUSHED FINISH                     | \$765.00 |
| FTBR-1450  | 14"x5"   | BRASS - 1MM, DIE CAST HOOPS, SS TENSION RODS, SR-160F STRAINER, BRUSHED FINISH                               | 899.00   |
| FTPB-1465  | 14"x6.5" | PHOSPHOR BRONZE - 1.2MM, DIE CAST HOOPS, SS TENSION RODS, SR-160F STRAINER, BRUSHED FINISH                   | 1,100.00 |
| FTAL-1480  | 14"x8"   | SEAMLESS ALUMINUM - 1.2MM, DIE CAST HOOPS, SS TENSION RODS, SR-160F STRAINER, BRUSHED FINISH                 | 1,030.00 |
| FTBB-1435  | 14"x3.5" | BIRCH - 6 PLY 5.4MM, DIE CAST HOOPS, SS TENSION RODS, SR-160F STRAINER, #320 SATIN BIRCH                     | 730.00   |
| FTMM-1450  | 14"x5"   | MAPLE - 6 PLY 7.5MM, DIE CAST HOOPS, SS TENSION RODS, SR-160F STRAINER, #321 SATIN MAPLE                     | 799.00   |
| FTMMH-1465 | 14"x6.5" | MAPLE/AFRICAN MAHOGANY - 6 PLY 7.5MM, DIE CAST HOOPS, SS TENSION RODS, SR-160F, #322 SATIN MAHOGANY ON MAPLE | 830.00   |
| FTMH-1480  | 14"x8"   | AFRICAN MAHOGANY - 8 PLY 10MM, DIE CAST HOOPS, SS TENSION RODS, SR-160F, #324 SATIN RED MAHOGANY             | 1,030.00 |

\*ACRYLIC FREE FLOATING REPLACEMENT SHELLS FOR ALL SIZES - SEE PAGE 11

## SENSITONE SNARE DRUMS

|            |          |   |          |
|------------|----------|---|----------|
| STA-1450S  | 14"x5"   | BEADED STEEL - 1MM, SUPERHOOP II, TB-55 LUGS, SR-150, SN-1420I, CHROME PLATED                             | \$499.00 |
| STA-1465S  | 14"x6.5" | BEADED STEEL - 1MM, SUPERHOOP II, TB-65 LUGS, SR-150, SN-1420I, CHROME PLATED                             | 515.00   |
| STA-1450BR | 14"x5"   | BEADED BRASS - 1MM, SUPERHOOP II, TB-55 LUGS, SR-150, SN-1420I, BLACK NICKEL PLATED                       | 749.00   |
| STA-1465BR | 14"x6.5" | BEADED BRASS - 1MM, SUPERHOOP II, TB-65 LUGS, SR-150, SN-1420I, BLACK NICKEL PLATED                       | 780.00   |
| STA-1450AL | 14"x5"   | BEADED SEAMLESS ALUMINUM - 1.2MM, SH II, TB-55 LUGS, SR-150, SN-1420I, CLEAR LACQUER FINISH               | 599.00   |
| STA-1465AL | 14"x6.5" | BEADED SEAMLESS ALUMINUM - 1.2MM, SH II, TB-65 LUGS, SR-150, SN-1420I, CLEAR LACQUER FINISH               | 615.00   |
| STA-1450FB | 14"x5"   | PREMIUM BEADED BRASS - 1.5MM, SUPERHOOP II, ARL-55 LUGS, SR-150, SN-1420I, PATINA FINISH                  | 965.00   |
| STA-1465FB | 14"x6.5" | PREMIUM BEADED BRASS - 1.5MM, SUPERHOOP II, ARL-65 LUGS, SR-150, SN-1420I, PATINA FINISH                  | 1,049.00 |
| STA-1450PB | 14"x5"   | PREMIUM BEADED PHOSPHOR BRONZE - 1.2MM, SUPERHOOP II, ARL-55 LUGS, SR-150, SN-1420I, CLEAR LACQUER FINISH | 980.00   |
| STA-1465PB | 14"x6.5" | PREMIUM BEADED PHOSPHOR BRONZE - 1.2MM, SUPERHOOP II, ARL-65 LUGS, SR-150, SN-1420I, CLEAR LACQUER FINISH | 1,049.00 |
| STA-1450MM | 14"x5"   | PREMIUM MAPLE - 6 PLY 5.4MM, SUPERHOOP II, ARL-55 LUGS, SR-150, SN-1420I, #321 SATIN MAPLE                | 649.00   |
| STA-1465MM | 14"x6.5" | PREMIUM MAPLE - 6 PLY 5.4MM, SUPERHOOP II, ARL-65 LUGS, SR-150, SN-1420I, #321 SATIN MAPLE                | 699.00   |
| STA-1550MH | 15"x5"   | PREMIUM AFRICAN MAHOGANY - 4 PLY 5MM w/MAPLE RINGS, SH II, ARL-55, SR-150, SN-1420I, #325 SATIN MAHOGANY  | 715.00   |

## HYBRID EXOTIC SNARE DRUMS w/SPIN-TIGHT TENSION RODS (TOP)

|           |          |   |            |
|-----------|----------|---|------------|
| HEP-1450  | 14"x5"   | VECTORCAST - SUPERHOOP II, STL-100 LUGS, SR-1000, SN-1420I  | \$1,215.00 |
| HEP-1465  | 14"x6.5" | VECTORCAST - SUPERHOOP II, STL-100 LUGS, SR-1000, SN-1420I  | 1,299.00   |
| HEAL-1450 | 14"x5"   | CAST ALUMINUM - 3MM, SUPERHOOP II, STL-100 LUGS, SR-1000, SN-1420I, BLACK LACQUER FINISH                        | 1,315.00   |
| HEAL-1465 | 14"x6.5" | CAST ALUMINUM - 3MM, SUPER HOOP II, STL-100 LUGS, SR-1000, SN-1420I, BLACK LACQUER FINISH                       | 1,330.00   |
| HEK-1450  | 14"x5"   | KAPUR/FIBERGLASS - 6 PLY 7.5MM, SUPERHOOP II, STL-100 LUGS, SR-1000, SN-1420I, #308 EBONY LACQUER w/PEARL INLAY | 980.00     |
| HEK-1465  | 14"x6.5" | KAPUR/FIBERGLASS - 6 PLY 7.5MM, SUPERHOOP II, STL-100 LUGS, SR-1000, SN-1420I, #308 EBONY LACQUER w/PEARL INLAY | 999.00     |
| HEK-1480  | 14"x8"   | KAPUR/FIBERGLASS - 6 PLY 7.5MM, SUPERHOOP II, STL-100 LUGS, SR-1000, SN-1420I, #308 EBONY LACQUER w/PEARL INLAY | 1,030.00   |

## SIGNATURE SERIES SNARE DRUMS

|                     |          |   |            |
|---------------------|----------|---|------------|
| <b>NEW</b> CS-1465F | 14"x6.5" | CHAD SMITH - 3MM BRASS/STEEL/BRASS STACKABLE SHELLS, DIE CAST HOOPS, SR-1000F, SS TENSION RODS, CLEAR LACQUER   | \$1,599.00 |
| CS-1450             | 14"x5"   | CHAD SMITH - STEEL, SUPERHOOP II, SR-015, STAINLESS STEEL TENSION RODS, BLACK NICKEL                            | 499.00     |
| OH-1350             | 13"x5"   | OMAR HAKIM - AFRICAN MAHOGANY 6 PLY 7.5MM, SUPERHOOP II, SR-015, SS TENSION RODS, #140 NATURAL MAHOGANY         | 730.00     |
| IP-1465             | 14"x6.5" | IAN PAICE - STEEL, TUBE LUGS, SUPERHOOP II, SR-017, STAINLESS STEEL TENSION RODS, CHROME                        | 660.00     |
| DC-1465             | 14"x6.5" | DENNIS CHAMBERS - MAPLE 4 PLY 5MM, DIE CAST HOOPS, SR-020 x 2, 20 LUGS, SS TENSION RODS, #136 OPAL WHITE        | 1,050.00   |
| JJ-1365             | 13"x6.5" | JOEY JORDISON - STEEL, SR-017, CL-65 LUGS, BLACK LACQUER/BLACK HARDWARE/SLIPKNOT GRAPHICS (WHILE SUPPLIES LAST) | 549.00     |

## REFERENCE SERIES SNARE DRUMS \*C=CHROME /B=BLACK CHROME PLATED /G=GOLD PLATED DRUM HARDWARE

|           |          |   |            |
|-----------|----------|---|------------|
| RF-1365S  | 13"x6.5" | 25MM 20PLY (14 MAPLE + 6 BIRCH) - BRL-65 LUGS, DIE CAST HOOPS, SR-1000 w/SN-1420D SNARES - HW COLOR: C/B/G* | \$1,250.00 |
| RF-1450S  | 14"x5"   | 25MM 20PLY (14 MAPLE + 6 BIRCH) - BRL-55 LUGS, DIE CAST HOOPS, SR-1000 w/SN-1420D SNARES - HW COLOR: C/B/G* | 1,200.00   |
| RF-1465S  | 14"x6.5" | 25MM 20PLY (14 MAPLE + 6 BIRCH) - BRL-65 LUGS, DIE CAST HOOPS, SR-1000 w/SN-1420D SNARES - HW COLOR: C/B/G* | 1,300.00   |
| RFP-1365S | 13"x6.5" | 5.4MM 6PLY (4 MAPLE + 2 BIRCH) - STL-65 LUGS, FAT TONE HOOPS, SR-1000 w/SN-1420D SNARES - CHROME HW ONLY    | 980.00     |
| RFP-1450S | 14"x5"   | 5.4MM 6PLY (4 MAPLE + 2 BIRCH) - STL-55 LUGS, FAT TONE HOOPS, SR-1000 w/SN-1420D SNARES - CHROME HW ONLY    | 1,050.00   |
| RFP-1465S | 14"x6.5" | 5.4MM 6PLY (4 MAPLE + 2 BIRCH) - STL-65 LUGS, FAT TONE HOOPS, SR-1000 w/SN-1420D SNARES - CHROME HW ONLY    | 1,100.00   |
| RFS-1450  | 14"x5"   | CAST STEEL - 3MM, BRL-55 LUGS, DIE CAST HOOPS, SR-1000 w/SN-1420D SNARES - CHROME HW ONLY                   | 1,300.00   |
| RFS-1465  | 14"x6.5" | CAST STEEL - 3MM, BRL-65 LUGS, DIE CAST HOOPS, SR-1000 w/SN-1420D SNARES - CHROME HW ONLY                   | 1,365.00   |
| RFB-1450  | 14"x5"   | BRASS SHELL - 3MM, BRL-55 LUGS, DIE CAST HOOPS, SR-1000 w/SN-1420D SNARES - CHROME HW ONLY                  | 1,650.00   |
| RFB-1465  | 14"x6.5" | BRASS SHELL - 3MM, BRL-65 LUGS, DIE CAST HOOPS, SR-1000 w/SN-1420D SNARES - CHROME HW ONLY                  | 1,830.00   |

## MASTERS SNARE DRUMS

|             |          |   |          |
|-------------|----------|---|----------|
| MCX-1455S/C | 14"x5.5" | 6 PLY 7.5MM MAPLE - DIE CAST HOOPS, CL-55 BRIDGE LUGS, STEEL TENSION RODS, SR-017 STRAINER, S-022N SNARES | \$640.00 |
| MCX-1465S/C | 14"x6.5" | 6 PLY 7.5MM MAPLE - DIE CAST HOOPS, CL-65 BRIDGE LUGS, STEEL TENSION RODS, SR-017 STRAINER, S-022N SNARES | 680.00   |
| BCX-1455S/C | 14"x5.5" | 6 PLY 7.5MM BIRCH - DIE CAST HOOPS, CL-55 BRIDGE LUGS, STEEL TENSION RODS, SR-017 STRAINER, S-022N SNARES | 500.00   |
| BCX-1465S/C | 14"x6.5" | 6 PLY 7.5MM BIRCH - DIE CAST HOOPS, CL-65 BRIDGE LUGS, STEEL TENSION RODS, SR-017 STRAINER, S-022N SNARES | 530.00   |

## SESSION SNARE DRUMS

|             |          |   |          |
|-------------|----------|---|----------|
| SSC-1455S/C | 14"x5.5" | 6 PLY BIRCH/KAPUR - SH II, CL-55 BRIDGE LUGS, SS TENSION RODS, SR-017 STRAINER, S-022N SNARES | \$350.00 |
| SSC-1465S/C | 14"x6.5" | 6 PLY BIRCH/KAPUR - SH II, CL-65 BRIDGE LUGS, SS TENSION RODS, SR-017 STRAINER, S-022N SNARES | 380.00   |

## PICCOLO / POPCORN / EFFECTS SNARE DRUMS

|         |        |  |          |
|---------|--------|--|----------|
| M-1060  | 10"x6" | 6 PLY MAPLE POPCORN SNARE CL-65 LUGS, 1.6MM HOOPS, SR-018 STRAINER, S-032 SNARES, #102 NATURAL MAPLE | \$520.00 |
| M-1270  | 12"x7" | 8 PLY MAPLE CL-100 LUGS, 1.6MM HOOPS, SR-018 STRAINER, S-031N SNARES, #114 LIQUID AMBER              | 680.00   |
| M-1330  | 13"x3" | 6 PLY MAPLE PICCOLO CL-05 LUGS, 1.6MM HOOPS, SR-018, #102 NATURAL MAPLE & #114 LIQUID AMBER          | 450.00   |
| B-1330  | 13"x3" | BRASS PICCOLO CL-05 LUGS, 1.6MM HOOPS, STEEL TENSION RODS, SR-018 STRAINER, S-029N SNARES            | 370.00   |
| S-1330B | 13"x3" | STEEL PICCOLO CL-05 LUGS, 1.6MM HOOPS, SR-018 STRAINER, S-029N SNARES, BLACK LACQUER                 | 280.00   |

## FIRECRACKER SNARE DRUMS

|          |        |   |          |
|----------|--------|---|----------|
| FCS-1050 | 10"x5" | STEEL - CL-50 LUGS, 1.6MM HOOPS, STEEL TENSION RODS, SR-018 STRAINER, S-032 SNARES                | \$230.00 |
| FCP-1250 | 12"x5" | 8 PLY POPLAR - CL-50 LUGS, 1.6MM HOOPS, STEEL TENSION RODS, SR-018, S-031 SNARES, #271 EBONY MIST | 260.00   |

# PEARL HARDWARE

## SINGLE PEDALS

|                          |   |                 |
|--------------------------|---|-----------------|
| <b>P-3000D</b><br>w/CASE | <b>DEMON DIRECT DRIVE</b> w/DUO-DECK CONVERTIBLE SHORT/LONG FOOTBOARD, INDEPENDENT BEATER & FOOTBOARD ANGLE ADJUSTMENTS, NINJA BEARINGS .....   | <b>\$529.00</b> |
| <b>P-3000C</b><br>w/CASE | <b>DEMON CHAIN DRIVE</b> w/DUO-DECK CONVERTIBLE SHORT/LONG FOOTBOARD, INDEPENDENT BEATER & FOOTBOARD ANGLE ADJUSTMENTS, NINJA BEARINGS .....    | <b>529.00</b>   |
| <b>P-2000C</b><br>w/CASE | <b>POWERSHIFTER ELIMINATOR</b> w/DUAL CHAIN DRIVE INTERCHANGEABLE CAM DRIVE SYSTEM, POWERSHIFTER, QUAD-BEATER, TRACTION-CONTROL FOOTBOARD ..... | <b>309.00</b>   |
| <b>P-2000B</b><br>w/CASE | <b>POWERSHIFTER ELIMINATOR</b> w/BELT DRIVE INTERCHANGEABLE CAM DRIVE SYSTEM, POWERSHIFTER, QUAD-BEATER, TRACTION-CONTROL FOOTBOARD .....       | <b>309.00</b>   |
| <b>P-930</b>             | <b>LONGBOARD</b> INTERCHANGEABLE CAM, POWERSHIFTER .....  | <b>149.00</b>   |
| <b>P-830</b>             | <b>LONGBOARD</b> w/RADIUS ROD .....   | <b>129.00</b>   |

## DOUBLE PEDALS - COMPLETE

|                          |   |                   |
|--------------------------|---|-------------------|
| <b>P-3002D</b><br>w/CASE | <b>DEMON DIRECT DRIVE</b> w/DUO-DECK CONVERTIBLE SHORT/LONG FOOTBOARD, Z-LINK ZERO-LATENCY DRIVE SHAFT, INDEPENDENT BEATER & FOOT BOARD ANGLE ADJUSTMENTS, NINJA BEARINGS ..... | <b>\$1,279.00</b> |
| <b>P-3002C</b><br>w/CASE | <b>DEMON CHAIN DRIVE</b> w/DUO-DECK CONVERTIBLE SHORT/LONG FOOTBOARD, Z-LINK ZERO-LATENCY DRIVE SHAFT, INDEPENDENT BEATER & FOOT BOARD ANGLE ADJUSTMENTS, NINJA BEARINGS .....  | <b>1,279.00</b>   |
| <b>P-3002DL</b>          | <b>DEMON DIRECT DRIVE L-FOOTED</b> w/CASE .....   | <b>1,279.00</b>   |
| <b>P-3002CL</b>          | <b>DEMON CHAIN DRIVE L-FOOTED</b> w/CASE .....  | <b>1,279.00</b>   |
| <b>P-2002C</b>           | <b>ELIMINATOR RIGHT-FOOTED</b> w/CASE - CHAIN DRIVE .....   | <b>679.00</b>     |
| <b>P-2002CL</b>          | <b>ELIMINATOR LEFT-FOOTED</b> w/CASE - CHAIN DRIVE .....  | <b>679.00</b>     |
| <b>P-2002B</b>           | <b>ELIMINATOR RIGHT-FOOTED</b> w/CASE - BELT DRIVE .....  | <b>679.00</b>     |
| <b>P-2002BL</b>          | <b>ELIMINATOR LEFT-FOOTED</b> w/CASE - BELT DRIVE .....   | <b>679.00</b>     |
| <b>P-932</b>             | <b>LONGBOARD RIGHT-FOOTED</b> - SINGLE CHAIN .....  | <b>399.00</b>     |
| <b>P-932L</b>            | <b>LONGBOARD LEFT-FOOTED</b> - SINGLE CHAIN .....   | <b>399.00</b>     |

## DOUBLE PEDAL CONVERSION KITS

|                |   |                 |
|----------------|---|-----------------|
| <b>P-3001D</b> | <b>DEMON DIRECT DRIVE R-FOOTED</b> w/CASE .....       | <b>\$899.00</b> |
| <b>P-3001C</b> | <b>DEMON CHAIN DRIVE R-FOOTED</b> w/CASE .....        | <b>899.00</b>   |
| <b>P-2001C</b> | <b>ELIMINATOR R-FOOTED</b> w/CASE - CHAIN DRIVE ..... | <b>499.00</b>   |
| <b>P-2001B</b> | <b>ELIMINATOR R-FOOTED</b> w/CASE - BELT DRIVE .....  | <b>499.00</b>   |
| <b>P-931</b>   | <b>LONGBOARD R-FOOTED</b> - SINGLE CHAIN .....        | <b>319.00</b>   |

## BOOM CYMBAL STANDS

|                |  |                 |
|----------------|--|-----------------|
| <b>BC-2030</b> | <b>GYRO-LOCK TILTER, TRIDENT TRIPOD, REVERSIBLE FOAM/FELT WASHERS, PUSH BUTTON SPIKE/RUBBER FEET "READY" w/TELESCOPIC BOOM ARM, WINGLOC, DETACHABLE TILTER &amp; COUNTERWEIGHT 1 1/8", 7/8", 5/8", 5/8" + 12MM ROD .....</b> | <b>\$379.00</b> |
| <b>BC-1030</b> | <b>GYRO-LOCK TILTER, TRIDENT TRIPOD, REVERSIBLE FOAM/FELT WASHERS, PUSH BUTTON SPIKE/RUBBER FEET "READY" w/WINGLOC 1 1/8", 7/8", 5/8" + 12MM ROD .....</b>   | <b>239.00</b>   |
| <b>BC-930</b>  | <b>UNI-LOCK TILTER, TRIDENT DESIGN TRIPOD 1 1/8", 7/8", 5/8" + 12MM ROD .....</b>  | <b>159.00</b>   |
| <b>BC-830</b>  | <b>UNI-LOCK TILTER DBL BR TRIPOD 1", 7/8", 5/8" + 12MM ROD .....</b>   | <b>119.00</b>   |

## CYMBAL STANDS

|               |   |                 |
|---------------|---|-----------------|
| <b>C-1030</b> | <b>GYRO-LOCK TILTER, TRIDENT TRIPOD, REVERSIBLE FOAM/FELT WASHERS, PUSH BUTTON SPIKE/RUBBER FEET "READY" w/WINGLOC - 1 1/8", 7/8", 5/8" .....</b> | <b>\$229.00</b> |
| <b>C-930</b>  | <b>UNI-LOCK TILTER, TRIDENT DESIGN TRIPOD - 1 1/8", 7/8", 5/8" .....</b>  | <b>139.00</b>   |
| <b>C-830</b>  | <b>UNI-LOCK TILTER DBL BR LEGS - 1", 7/8", 5/8" .....</b>   | <b>99.00</b>    |

## SNARE STANDS

|               |  |                 |
|---------------|--|-----------------|
| <b>S-1030</b> | <b>GYRO-LOCK TILTER, TRIDENT TRIPOD, PUSH BUTTON SPIKE/RUBBER FEET "READY," ALL-FIT BASKET (10"-16") AIR SUSPENSION TIPS 1 1/8", 7/8" - (18.5" ~ 25.98") .....</b> | <b>\$249.00</b> |
| <b>S-930</b>  | <b>UNI-LOCK TILTER, TRIDENT DESIGN TRIPOD, AIR SUSPENSION TIPS, FITS 10"~ 14" DRUMS 1 1/8", 7/8" - (18.11" ~ 25.59") .....</b>                                     | <b>119.00</b>   |
| <b>S-930D</b> | <b>S-930 LOW VERSION - 1 1/8", 7/8" - (14.57" ~ 21.65") .....</b>  | <b>139.00</b>   |
| <b>S-830</b>  | <b>UNI-LOCK TILTER - 1", 7/8" - (16.93" ~ 24.41") .....</b>  | <b>99.00</b>    |

## HI-HAT STANDS

|                |   |                 |
|----------------|---|-----------------|
| <b>H-2000</b>  | <b>ELIMINATOR</b> w/INTERCHANGEABLE CAM SYSTEM SUPERGRIP CLUTCH w/LOCK NUT, PUSH BUTTON SPIKE/RUBBER TIPS, SWIVEL LEGS - 1 1/8", 1" ..... | <b>\$509.00</b> |
| <b>RH-2000</b> | <b>ELIMINATOR REMOTE-HAT</b> w/8 FOOT CABLE, DROP CLUTCH, FOOTBOARD DOCKING STATION .....   | <b>509.00</b>   |
| <b>H-1000</b>  | <b>DIRECT DRIVE</b> w/SPIKE/RUBBER TIPS, ADJUSTABLE FOOTBOARD ANGLE, SWIVEL LEGS - 1 1/8", 1" .....                                       | <b>375.00</b>   |
| <b>H-930</b>   | <b>LONGBOARD</b> - SWIVEL LEGS, ADJ SPRING - 1 1/8", 7/8" .....   | <b>219.00</b>   |
| <b>H-830</b>   | <b>LONGBOARD</b> - SWIVEL LEGS - 1", 7/8" .....   | <b>140.00</b>   |

## ROADSTER THRONES

|                  |   |                 |
|------------------|---|-----------------|
| <b>D-2500BR</b>  | <b>BACKREST THRONE</b> w/MOTORCYCLE-TYPE SEAT, LOCKING SEAT BRACKET, QUICK-RELEASE BACKREST w/ADJUSTABLE LUMBAR SUPPORT, TRIDENT DESIGN TRIPOD - 1 1/8", 7/8" - (19.49" ~ 26.18") ..... | <b>\$499.00</b> |
| <b>D-2500</b>    | <b>MOTORCYCLE-TYPE SEAT</b> - BACKREST READY, LOCKING SEAT BRACKET, TRIDENT DESIGN TRIPOD 1 1/8", 7/8" - (19.49" ~ 26.18") .....  | <b>379.00</b>   |
| <b>D-1000N</b>   | <b>ROUND SEAT</b> w/HI-DENSITY FOAM, LOCKING SEAT BRACKET, NEW TRIDENT DESIGN TRIPOD 1 1/8", 7/8" - (19.49" ~ 26.18") .....   | <b>299.00</b>   |
| <b>D-1000SN</b>  | <b>SHORT D-1000N</b> - 1 1/8", 7/8" - (17.91" ~ 24.61") .....   | <b>299.00</b>   |
| <b>D-1000SPN</b> | <b>SHOCK ABSORBER POST</b> w/ROUND SEAT, LOCKING SEAT BRACKET, TRIDENT DESIGN TRIPOD 1 1/8", 1" - (20.67" ~ 24.8") .....  | <b>299.00</b>   |

## THRONES

|               |   |                 |
|---------------|---|-----------------|
| <b>D-930</b>  | <b>ROUND SEAT</b> - TRIDENT DESIGN TRIPOD, POST w/STOP LOCK - 1 1/8", 7/8" - (18.5" ~ 25.98") ..... | <b>\$169.00</b> |
| <b>D-790</b>  | <b>ROUND SEAT</b> - DOUBLE BRACED TRIPOD, POST w/STOP LOCK 1 1/8", 7/8" - (18.11" ~ 25.98") .....   | <b>119.00</b>   |
| <b>D-730S</b> | <b>ROUND SEAT</b> - SINGLE BRACED TRIPOD, POST w/STOP LOCK 1 1/8", 7/8" - (15.94" ~ 22.83") .....   | <b>109.00</b>   |

## TOM STANDS

|               |   |                 |
|---------------|---|-----------------|
| <b>T-1030</b> | <b>TRIDENT TRIPOD PUSH BUTTON SPIKE/RUBBER FEET "READY" w/(2) NEW GYRO-LOCK TH-1030S &amp; ADP-30 .....</b> | <b>\$389.00</b> |
| <b>T-930</b>  | <b>TRIDENT DESIGN TRIPOD</b> w/(2) TH-900S & ADP-30 .....   | <b>279.00</b>   |
| <b>T-890</b>  | FOR ROCKET & CONCERT TOMS .....   | <b>239.00</b>   |

## TOM / CYMBAL STANDS

|                |   |                 |
|----------------|---|-----------------|
| <b>TC-1030</b> | <b>TRIDENT TRIPOD, PUSH BUTTON SPIKE/RUBBER FEET "READY" w/GYRO-LOCK TH-1030S &amp; CH-1030 .....</b> | <b>\$439.00</b> |
| <b>TC-930</b>  | <b>TRIDENT DESIGN TRIPOD</b> w/TH-900S & CH-930 .....   | <b>309.00</b>   |

## MULTI-FIT BASS DRUM LEGS

|                 |  |                 |
|-----------------|--|-----------------|
| <b>PMBDL3/C</b> | SUSPENDS CONCERT-MARCHING-DRUMSET BASS DRUMS HORIZONTALLY NO DRILLING! HEIGHT & TILT ADJ - SET OF 3 - CHROME PLATED .. | <b>\$332.00</b> |
|-----------------|--|-----------------|

## RACKS

|                 |   |                 |
|-----------------|---|-----------------|
| <b>DR-503</b>   | <b>ICON 3-SIDED RACK w/36" STRAIGHT BARS</b> HEIGHT ADJUSTABLE, (4) PCX-100, (2) PCL-100 .....                          | <b>\$769.00</b> |
| <b>DR-503C</b>  | <b>ICON 3-SIDED RACK w/44" CURVED BARS</b> HEIGHT ADJUSTABLE, (4) PCX-100, (2) PCL-100 .....                            | <b>769.00</b>   |
| <b>DR-501</b>   | <b>ICON FRONT RACK w/36" STRAIGHT BAR</b> HEIGHT ADJUSTABLE, (2) PCX-100, (2) PCL-100 .....                             | <b>359.00</b>   |
| <b>DR-501C</b>  | <b>ICON FRONT RACK w/44" CURVED BAR</b> HEIGHT ADJUSTABLE, (2) PCX-100, (2) PCL-100 .....                               | <b>379.00</b>   |
| <b>DR-501E</b>  | <b>ICON STRAIGHT 36" EXPANSION BAR .....</b>  | <b>199.00</b>   |
| <b>DR-501CE</b> | <b>ICON CURVED 44" EXPANSION BAR .....</b>  | <b>229.00</b>   |
| <b>DR-100L</b>  | <b>ICON SHORT LEG - LEFT</b> - USED TO CONVERT DR-503C RACKS FOR DOUBLE BASS - REQUIRES 1 x DR-100R & 2 x RJ-100 .....  | <b>159.00</b>   |
| <b>DR-100R</b>  | <b>ICON SHORT LEG - RIGHT</b> - USED TO CONVERT DR-503C RACKS FOR DOUBLE BASS - REQUIRES 1 x DR-100L & 2 x RJ-100 ..... | <b>159.00</b>   |
| <b>DR-80</b>    | <b>3-SIDED RACK w/35.9" STRAIGHT BARS, (4) PC-8 .....</b>   | <b>349.00</b>   |
| <b>DR-008</b>   | <b>DR-80 EXPANSION BAR .....</b>  | <b>119.00</b>   |

## RACK ACCESSORIES

|                |   |                |
|----------------|---|----------------|
| <b>RJ-50</b>   | <b>ICON 6" MINI-EXPANSION BAR .....</b>                       | <b>\$99.00</b> |
| <b>RJ-100</b>  | <b>PIPE JOINT</b> USED WITH DR-100L / DR-100R .....           | <b>60.00</b>   |
| <b>PCX-100</b> | <b>PIPE CLAMP</b> w/ADJUSTABLE JAW FOR ICON/DR110/DR210 ..... | <b>49.00</b>   |
| <b>PCX-200</b> | <b>PIPE CLAMP</b> w/TILTING CLAMP & ADJUSTABLE JAW .....      | <b>55.00</b>   |
| <b>PC-8</b>    | <b>PIPE CLAMP</b> FOR DR-80 - FITS 7/8" TUBES .....           | <b>39.00</b>   |
| <b>PCL-100</b> | <b>PIPE CLAMP</b> FITS 1.5" LEG TUBES FOR 7/8" TUBES .....    | <b>29.00</b>   |

## 930 SERIES HARDWARE PACK w/UNI-LOCK TILTERS

|                |  |                 |
|----------------|--|-----------------|
| <b>HWP-930</b> | BC-930, C-930, H-930, S-930, P-930 ..... | <b>\$770.00</b> |
|----------------|--|-----------------|

## 830 SERIES HARDWARE PACK w/UNI-LOCK TILTERS

|                |  |                 |
|----------------|--|-----------------|
| <b>HWP-830</b> | BC-830, C-830, H-830, S-830, P-930 ..... | <b>\$599.00</b> |
|----------------|--|-----------------|

## ADAPTERS & ACCESSORIES

### BOOM CYMBAL HOLDERS

|         |  |                 |
|---------|--|-----------------|
| CH-1030 | GYRO-LOCK TILTER - WINGLOC, BUILT-IN COWBELL ROD, 7/8" DIA. POST w/STOP LOCK ..... | <b>\$149.00</b> |
| CH-930  | UNI-LOCK TILTER - 7/8" DIA POST w/STOP LOCK .....                                  | <b>99.00</b>    |
| CH-830  | UNI-LOCK TILTER - 7/8" DIA POST w/STOP LOCK .....                                  | <b>69.00</b>    |
| CH-70   | GEAR TILTER w/QUICK RELEASE BRKT .....   | <b>69.00</b>    |

### TOM HOLDERS

|          |  |                 |
|----------|--|-----------------|
| TH-1030  | GYRO-LOCK TILTER (14"x4") w/7/8" DIA POST .....    | <b>\$139.00</b> |
| TH-1030I | GYRO-LOCK TILTER (14"x3") w/7/8" DIA POST .....    | <b>139.00</b>   |
| TH-1030S | GYRO-LOCK TILTER (5"x4") w/7/8" DIA POST .....     | <b>139.00</b>   |
| TH-900I  | UNI-LOCK (13"x3") FOR VISION w/7/8" DIA POST ..... | <b>79.00</b>    |
| TH-900S  | UNI-LOCK (4"x4") FOR VISION w/7/8" DIA POST .....  | <b>79.00</b>    |
| TH-88I   | GEAR (13"x3") w/7/8" DIA POST .....                | <b>59.00</b>    |
| TH-88S   | GEAR (4"x4") w/7/8" DIA POST .....                 | <b>59.00</b>    |
| TH-70I   | GEAR (13"x3") w/7/8" DIA POST .....                | <b>49.00</b>    |
| TH-70S   | GEAR (4"x4") w/7/8" DIA POST .....                 | <b>49.00</b>    |

### OPTIMOUNT

|             |   |                 |
|-------------|---|-----------------|
| OPTA-0665/C | 6.5" DEPTH x 6"-16" DIA - ALUMINUM .....    | <b>\$133.00</b> |
| OPTA-0708/C | 7"-8" DEPTH x 6"-16" DIA - ALUMINUM .....   | <b>133.00</b>   |
| OPTA-0910/C | 9"-10" DEPTH x 6"-16" DIA - ALUMINUM .....  | <b>133.00</b>   |
| OPTA-1112/C | 11"-12" DEPTH x 6"-16" DIA - ALUMINUM ..... | <b>133.00</b>   |
| OPTA-1314/C | 13"-14" DEPTH x 6"-16" DIA - ALUMINUM ..... | <b>133.00</b>   |
| OPTA-1516/C | 15"-16" DEPTH x 6"-16" DIA - ALUMINUM ..... | <b>133.00</b>   |
| OPT-0708    | 7"-8" DEPTH x 6"-16" DIA - STEEL .....      | <b>72.00</b>    |
| OPT-0910    | 9"-10" DEPTH x 6"-16" DIA - STEEL .....     | <b>72.00</b>    |
| OPT-1112    | 11"-12" DEPTH x 6"-16" DIA - STEEL .....    | <b>72.00</b>    |
| OPT-1314    | 13"-14" DEPTH x 6"-16" DIA - STEEL .....    | <b>72.00</b>    |
| OPT-1516    | 15"-16" DEPTH x 6"-16" DIA - STEEL .....    | <b>72.00</b>    |
| OPL-0608/C  | OPTI-LOC FOR EXX (ONLY) 6" & 8" DIA .....   | <b>49.00</b>    |
| OPL-1016/C  | OPTI-LOC FOR EXX (ONLY) 10" ~ 16" DIA ..... | <b>49.00</b>    |

### I.S.S.

|             |   |                |
|-------------|---|----------------|
| ISS-0810    | FITS 8"-10" 1.6MM VISION w/BT-300 .....               | <b>\$49.00</b> |
| ISS-1216    | FITS 12"-16" 1.6MM VISION w/BT-300 .....              | <b>49.00</b>   |
| IS-0810SL/C | FITS 8"-10" 2MM STEEL/STAINLESS & SH II w/BT-3 .....  | <b>49.00</b>   |
| IS-1216SL/C | FITS 12"-16" 2MM STEEL/STAINLESS & SH II w/BT-3 ..... | <b>49.00</b>   |

### ADAPTERS

|        |   |                |
|--------|---|----------------|
| ADP-20 | 2 QUICK RELEASE CLAMPS FITS 5/8"-1 1/8" .....                     | <b>\$49.00</b> |
| ADP-30 | 3 QUICK RELEASE CLAMPS FITS 3/8"-1 1/4" .....                     | <b>79.00</b>   |
| AX-25  | 2 QUICK RELEASE REVOLVING CLAMPS FITS 1/2"-1 1/8" .....           | <b>58.00</b>   |
| AX-25L | LONG VERSION OF THE AX-25 .....                                   | <b>65.00</b>   |
| AX-28  | FIXED QR CLAMP 5/8"-1 1/8" + REVOLVING QR CLAMP 1/2"-1 1/8" ..... | <b>58.00</b>   |
| UX-80  | QR REVOLVING CLAMP FITS 1/2"-1 1/8" w/13" LONG 7/8" DIA TUBE ..   | <b>72.00</b>   |
| UX-80S | QR REVOLVING CLAMP FITS 1/2"-1 1/8" w/4" LONG 7/8" DIA TUBE ....  | <b>72.00</b>   |

### COWBELL HOLDERS

|        |   |                |
|--------|---|----------------|
| 75H    | HOOP MOUNTED w/NON-MARRING CLAMP SURFACES .....   | <b>\$39.00</b> |
| 75X    | 7/8" DIA POST w/GEAR TILTER .....                 | <b>49.00</b>   |
| CA-130 | NEW HOOP CLAMP SYSTEM - FULLY ADJUSTABLE .....    | <b>49.00</b>   |
| PPS-37 | MULTI-ANGLE "L" ARM w/QUICK RELEASE BRACKET ..... | <b>49.00</b>   |

### BASS PEDAL ACCESSORIES

|       |   |                |
|-------|---|----------------|
| PS-85 | PEDAL STABILIZER FOR DOUBLE PEDALS .....                                    | <b>\$49.00</b> |
| JG-16 | JUNGLE GIG - 16" FT TO BASS DRUM CONVERSION KIT (I.S.S. NOT INCLUDED) ..... | <b>59.00</b>   |

### HI-HAT ACCESSORIES

|         |  |                 |
|---------|--|-----------------|
| CLH-930 | CLOSED HAT w/KNURLED BOOM ARM, UNI-LOCK .....  | <b>\$149.00</b> |
| HA-130  | HI-HAT TO BD ATTACHMENT w/NEW HOOP CLAMP ..... | <b>95.00</b>    |

### SNARE STAND ACCESSORIES

|         |  |                |
|---------|--|----------------|
| SBA-1/3 | SNARE BASKET ADAPTER ACCEPTS 10" DRUMS .....         | <b>\$31.00</b> |
| TX-100  | HEIGHT EXTENDER FOR 7/8" DIA. TUBES - 13" TALL ..... | <b>69.00</b>   |

### ACCESSORY PACKS

|       |   |                |
|-------|---|----------------|
| UGK-1 | UPGRADE KIT w/QUAD BEATER, R-40, NP-210/2, NP-208 ..... | <b>\$62.00</b> |
|-------|---|----------------|

### PRACTICE PADS

|         |   |                 |
|---------|---|-----------------|
| SD-50   | 8" PAD w/STAND - SOFT FEEL .....                          | <b>\$149.00</b> |
| BD-10   | BASS PRACTICE PAD .....                                   | <b>149.00</b>   |
| RP-50   | RUBBER DISK SET 12", 13", 14", 16", BD .....              | <b>259.00</b>   |
| RP-40C  | RUBBER CYMBAL PADS 18/20 RIDE, 14/16 CRASH, 14 HATS ..... | <b>129.00</b>   |
| RPG-14  | 14" TWO-LEVEL RUBBER PRACTICE PAD .....                   | <b>35.00</b>    |
| RT-08PL | 8" REMO TUNEABLE PRACTICE PAD .....                       | <b>51.00</b>    |
| PH-0108 | REPLACEMENT DRUM HEAD FOR RT-08PL ONLY .....              | <b>14.00</b>    |

## DRUM PARTS

### STRAINERS

|          |                                  |                |
|----------|----------------------------------|----------------|
| SR-012   | VERTICAL PULL - COMPLETE .....   | <b>\$46.00</b> |
| SR-700/C | FORUM FZH - COMPLETE .....       | <b>58.00</b>   |
| SR-015   | GLADSTONE TYPE - COMPLETE .....  | <b>58.00</b>   |
| SR-017   | SENSITONE & MCX - COMPLETE ..... | <b>50.00</b>   |
| SR-018   | PICCOLO (COMPLETE) .....         | <b>46.00</b>   |
| SR-020   | MULTI-TRACE (COMPLETE) .....     | <b>69.00</b>   |

|          |  |                |
|----------|--|----------------|
| SR-900   | VISION VML-VBL-VBA-VB (COMPLETE) .....                     | <b>\$84.00</b> |
| SR-1000  | GLIDE-LOCK (COMPLETE) .....                                | <b>189.00</b>  |
| SR-1000F | GLIDE-LOCK FOR FREE FLOATER (COMPLETE) .....               | <b>189.00</b>  |
| SR-160F  | FREE FLOATER 2014 w/CLICK-LOCK TECHNOLOGY (COMPLETE) ..... | <b>81.00</b>   |
| SR-150   | SENSITONE 2014 w/CLICK-LOCK TECHNOLOGY (COMPLETE) .....    | <b>93.00</b>   |

### SNARES

|          |   |                |
|----------|---|----------------|
| SN-1320I | 20 STRAND ULTRASOUND - "I" TYPE FOR 13" w/CORDS ..... | <b>\$23.00</b> |
| SN-1320C | 20 STRAND ULTRASOUND - "C" TYPE FOR 13" w/CORDS ..... | <b>23.00</b>   |
| SN-1320D | 20 STRAND ULTRASOUND - "D" TYPE FOR 13" w/CORDS ..... | <b>23.00</b>   |
| SN-1420I | 20 STRAND ULTRASOUND - "I" TYPE FOR 14" w/CORDS ..... | <b>21.00</b>   |
| SN-1420C | 20 STRAND ULTRASOUND - "C" TYPE FOR 14" w/CORDS ..... | <b>21.00</b>   |
| SN-1420D | 20 STRAND ULTRASOUND - "D" TYPE FOR 14" w/CORDS ..... | <b>21.00</b>   |
| SN-1442I | 42 STRAND ULTRASOUND - "I" TYPE FOR 14" w/CORDS ..... | <b>53.00</b>   |
| SN-1442C | 42 STRAND ULTRASOUND - "C" TYPE FOR 14" w/CORDS ..... | <b>53.00</b>   |
| SN-1442D | 42 STRAND ULTRASOUND - "D" TYPE FOR 14" w/CORDS ..... | <b>53.00</b>   |
| S-022N   | 20 STRAND FOR 14" w/CORDS .....                       | <b>17.00</b>   |
| S-022NU  | 20 STRAND FOR 14" w/CORDS - UNCOATED .....            | <b>17.00</b>   |

|          |   |                |
|----------|---|----------------|
| S-022NG  | 20 STRAND FOR 14" w/CORDS - GOLD PLATED ..... | <b>\$47.00</b> |
| S-022    | 20 STRAND w/STRAPS FOR 14" .....              | <b>15.00</b>   |
| S-029N   | 20 STRAND w/CORDS FOR 13" .....               | <b>17.00</b>   |
| S-030N   | 24 STRAND w/CORDS FOR 14" .....               | <b>21.00</b>   |
| S-031N   | 20 STRAND w/CORDS FOR 12" .....               | <b>17.00</b>   |
| S-032N   | 12 STRAND w/CORDS FOR 10" .....               | <b>16.00</b>   |
| S-033N   | 12 STRAND w/CORDS FOR 12" .....               | <b>16.00</b>   |
| S-040    | 15 STRAND STEEL CABLE w/CORDS FOR 14" .....   | <b>47.00</b>   |
| S-041    | 15 STRAND BRONZE CABLE w/CORDS FOR 14" .....  | <b>53.00</b>   |
| SPS-18/6 | PLASTIC STRAPS (6/PKG) .....                  | <b>4.00</b>    |
| SNC-40/6 | SNARE CORD (6/PKG) .....                      | <b>4.00</b>    |

### BASS DRUM PARTS

|            |                                       |                 |
|------------|---------------------------------------|-----------------|
| SP-300/2   | SPURS FOR MW/RF/RF PURE (PAIR) .....  | <b>\$189.00</b> |
| SP-30/2    | SPURS FOR MCX (PAIR) .....            | <b>126.00</b>   |
| BSP-300C/2 | SPURS FOR VML-VBL-VBA-VB (PAIR) ..... | <b>158.00</b>   |
| BSP-70C/2  | SPURS FOR FORUM FZH (PAIR) .....      | <b>116.00</b>   |
| R-30A/2    | RUBBER TIPS FOR SP-30 (PAIR) .....    | <b>12.00</b>    |
| CW-300     | CLAW FOR MW/RF/RF PURE .....          | <b>15.00</b>    |
| D-054      | CLAW FOR MCX/SSC .....                | <b>8.00</b>     |

|            |   |                |
|------------|---|----------------|
| BDCWAV16   | CHROME CLAW & T-ROD SET FOR ALL VISION (16) .....       | <b>\$99.00</b> |
| BDCWAV16/B | BLACK CLAW & T-ROD SET FOR VBL-VB (16) .....            | <b>99.00</b>   |
| HPP-2      | METAL HOOP PROTECTOR FOR WOOD HOOPS .....               | <b>5.00</b>    |
| NP-347/2   | NON-SLIP HOOP PROTECTOR FOR WOOD HOOPS (2) .....        | <b>5.00</b>    |
| NP-01      | HOOP PROTECTOR FOR METAL HOOPS .....                    | <b>3.00</b>    |
| BB-3       | BD BRACKET w/TWIN 7/8" RECEIVERS .....                  | <b>57.00</b>   |
| BB-70/C    | BD BRACKET w/TWIN 7/8" RECEIVERS FOR FZH - CHROME ..... | <b>40.00</b>   |
| BBC-1      | MASKING PLATE FOR BB-3 .....                            | <b>18.00</b>   |

### RACK TOM & FLOOR TOM PARTS

|          |   |                |
|----------|---|----------------|
| BT-3     | TT BRACKET 7/8" RECEIVER .....                              | <b>\$34.00</b> |
| GK-90    | MASKING PLATE FOR BT-3 w/INSIDE/OUTSIDE PLATES & BOLTS ..   | <b>9.00</b>    |
| LB-200   | LEG BRKT FOR MASTERWORKS/RF/RFP/MASTERS PREMIUM ....        | <b>28.00</b>   |
| LG-200/3 | LEGS (3) FOR MW/RF/RFP/MP w/AIR SUSPENSION FEET - 3/8" DIA  | <b>81.00</b>   |
| LB-40    | LEG BRKT FOR MCX/VMX .....                                  | <b>19.00</b>   |
| LG-40/3  | LEGS (3) FOR MCX/VMX w/AIR SUSPENSION FEET - 3/8" DIA - 21" | <b>55.00</b>   |
| LG-40L/3 | LEGS (3) FOR MCX/VMX EXTRA LONG - 27" .....                 | <b>67.00</b>   |

|            |  |                |
|------------|--|----------------|
| FTB-200/C  | LEG BRKT FOR VBL/VBA/VB .....                    | <b>\$25.00</b> |
| FTL-200C/3 | LEGS FOR VBL/VBA/VB (3) .....                    | <b>36.00</b>   |
| FTB-07/C   | LEG BRKT FOR FORUM FZH .....                     | <b>15.00</b>   |
| FTL-07C/3  | LEGS FITS FTB-07 & LB-15 LEG BRKTS (3) .....     | <b>32.00</b>   |
| R-40/3     | AIR SUSPENSION FEET FITS 3/8" DIA LEGS (3) ..... | <b>19.00</b>   |
| R-5/3      | FEET FITS 3/8" DIA LEGS (3) .....                | <b>7.00</b>    |

# HARDWARE PARTS

## THRONE PARTS

BR-2500A BACKREST & BRACKET FOR D-2500 THRONE ..... \$157.00

## PUSH BUTTON SPIKE/RUBBER FEET

CVT-300/3 FOR BC-2030, BC-1030, C-1030, S-1030, S-1030L,  
T-1030, TC-1030 - SET OF THREE ..... \$131.00

## BOOM / CYMBAL STAND PARTS

TL-2030 GYROLOCK TILTER UNIT FOR BC-2030 & BC-2000 ..... \$99.00  
 WL-200 WINGLOC QUICK RELEASE WINGNUT 8MM THREAD ..... 15.00  
 M-8W/2 WING NUT FOR TILTER W/8MM THREAD (2) ..... 6.00  
 FL-90/2 CYMBAL FELT - LARGE (2) ..... 6.00  
 NP-69/2 PLASTIC SLEEVE FOR TILTER (2) ..... 4.00  
 PR-135 STEEL CUP WASHER ..... 4.00  
 RC-20 REVERSIBLE SEAT CUP W/O-RING ..... 5.00

## BASS PEDAL PARTS

AL-24A TRACTION PLATE w/SCREWS FOR ELIMINATOR PEDALS ..... \$8.00  
 DB-150 DUO-BEAT BEATER w/CONTROL CORE FOR 930 PEDALS ..... 27.00  
 DB-100 DUO-BEAT BEATER ..... 29.00  
 B-200QB QUAD BEATER ..... 41.00  
 B-300F CONTROL CORE BEATER - FELT ..... 52.00  
 B-300W CONTROL CORE BEATER - WOOD ..... 52.00  
 BCA-1 BELT ASSY COMPLETE FOR ELIMINATOR PEDALS ..... 29.00  
 BCA-10 BELT ASSY COMPLETE FOR 1000 SERIES PEDALS ..... 25.00  
 BW-100 BEATER WEIGHT - 3 WEIGHTS IN ONE ..... 16.00  
 CCA-1 CHAIN ASSY FOR 100 SERIES POWER SHIFTER/POWERPRO ..... 12.00  
 CCA-5 CHAIN ASSY FOR ELIMINATOR PEDALS ..... 48.00  
 CCA-10 CHAIN ASSY FOR 1000 SERIES PEDALS ..... 23.00  
 CAMBK ELIMINATOR BLACK CAM - LINEAR ACTION ..... 15.00  
 CAMWT ELIMINATOR WHITE CAM - OVERSIZED LINEAR ACTION ..... 15.00  
 CAMBL ELIMINATOR BLUE CAM - PROGRESSIVE ACTION ..... 15.00  
 CAMRD ELIMINATOR RED CAM - RADICAL ACTION ..... 15.00  
 CAMPL ELIMINATOR PURPLE CAM - AGGRESSIVE ACTION ..... 15.00  
 CAMYL ELIMINATOR YELLOW CAM - INVERSE ACTION ..... 15.00  
 DC-746A TOE STOPPER ASSEMBLY - P-3000 PEDALS ..... 11.00  
 DS-200A DRIVE SHAFT COMPLETE FOR ALL PEARL DOUBLE PEDALS ..... 139.00  
 DS-300A DRIVE SHAFT COMPLETE FOR DEMON DRIVE DBL PEDALS ..... 262.00  
 EPAP-1 PKG: BEATER WEIGHT, PURPLE CAM, YELLOW CAM ..... 34.00  
 KB-508/6 KEY BOLT M5x8MM FOR UNIVERSAL JOINT (6) ..... 5.00  
 KB-610/6 KEY BOLT M6x10MM FOR DRIVE SHAFT (6) ..... 5.00  
 KB-814/3 KEY BOLT M8x14MM FOR BEATER HOLDER LINK (3) ..... 4.00  
 NP-283N/7 TRACTION GRIP DOTS FOR ELIMINATOR PEDALS (7) ..... 5.00  
 OL-300 NINJA BEARING OIL ..... 4.00  
 PS-300 ANCHOR FOR DEMON DRIVE PEDALS (1 PAIR) ..... 17.00  
 SC-363L/12 SCREWS FOR TRACTION PLATE FOR ELIMINATOR PEDALS (4) ..... 9.00  
 SP-31F SPRING w/FELT FOR 900 SERIES PEDALS ..... 6.00  
 SP-64F SPRING w/FELT FOR ELIMINATOR PEDALS ..... 11.00  
 SP-64NF SPRING w/FELT FOR DEMON DRIVE PEDALS ..... 11.00

## PEDAL BAGS

DPB-1 SINGLE DEMON DRIVE PEDAL BAG ..... \$81.00  
 DPB-2 DOUBLE DEMON DRIVE PEDAL BAG ..... 93.00  
 EPB-1 SINGLE ELIMINATOR PEDAL BAG ..... 81.00  
 EPB-2 DOUBLE ELIMINATOR PEDAL BAG ..... 93.00

## HI-HAT STAND PARTS

SGC-300P SUPER GRIP CLUTCH w/RUBBER WASHERS & LOCK NUT ..... \$34.00  
 DCCL-300P DROP CLUTCH w/RUBBER WASHERS & LOCK NUT ..... 42.00  
 CL-300P TRIPLE-LOCK CLUTCH w/RUBBER WASHERS & LOCK NUT ..... 22.00  
 CL-300 TRIPLE-LOCK CLUTCH w/FELT WASHERS & LOCK NUT ..... 25.00  
 HCL-90 STANDARD CLUTCH w/FELT WASHERS ..... 29.00  
 HCL-79 STANDARD CLUTCH w/FELT WASHERS ..... 19.00  
 NP-208 RUBBER CUP WASHER - MINIMAL-CONTACT ..... 4.00  
 NP-210/2 RUBBER CLUTCH WASHERS (2) ..... 4.00  
 FE-17 FELT WASHER ..... 4.00  
 FL-95/2 FELT CLUTCH WASHERS (2) ..... 6.00  
 PR-128 STEEL BOTTOM WASHER ..... 4.00  
 HHC-1 SEAT CUP w/TILTER SCREW & SPRING ..... 6.00  
 ME-145 21" PULL ROD 7MM DIA ..... 6.00  
 ME-145SA 18" PULL ROD 7MM DIA ..... 6.00  
 CCA-5H CHAIN ASSY w/END CONNECTORS FOR H-2000/RH-2000 ..... 34.00  
 CAU-2000 8 FOOT CABLE ASSY FOR RH-2000 ..... 139.00

## WING BOLTS / WING NUTS

UGB-610/2 WING BOLT M6 x 10MM (2) ..... \$5.00  
 UGB-620/2 WING BOLT M6 x 20MM (2) ..... 6.00  
 UGB-815/2 WING BOLT M8 x 15MM (2) ..... 5.00  
 UGB-820/2 WING BOLT M8 x 20MM (2) ..... 5.00  
 UGN-6/2 WING NUT M6 (2) ..... 5.00  
 UGN-8/2 WING NUT M8 (2) ..... 5.00  
 UGN-8L WING NUT M8 LARGE HANDLE ..... 5.00  
 M-8RN/2 KNURLED ROUND NUT M8 (2) ..... 6.00

## DRUM KEYS

KGT-100H GYRO TUNE KEY w/QUICK RELEASE NECK STRAP ..... \$23.00  
 KMF-300 MULTI-FUNCTION KEY FOR DEMON DRIVE PEDALS ..... 11.00  
 K-180 SPIN-TIGHT KEY ALSO FITS STANDARD TENSION RODS ..... 30.00  
 K-80 DRUM KEY ..... 7.00  
 K-030 HIGH TORQUE KEY ..... 12.00

## TENSION RODS / WASHERS / LOCK NUTS

T-055/6 W7/32 x 28MM (1.1") (6/PACK) ..... \$6.00  
 T-060/6 W7/32 x 35MM (1.38") (6/PACK) ..... 6.00  
 T-061/6 W7/32 x 42MM (1.65") (6/PACK) ..... 6.00  
 T-061L/6 W7/32 x 47MM (1.85") (6/PACK) ..... 6.00  
 T-062/6 W7/32 x 52MM (2") (6/PACK) ..... 6.00  
 T-062F/6 W7/32 x 52MM w/CLAWS FOR SINGLE FLANGE HOOPS (6) ..... 23.00  
 T-062L/6 W7/32 x 57MM (2.24") (6/PACK) ..... 6.00  
 T-063L/6 W7/32 x 67MM (2.64") (6/PACK) ..... 6.00  
 T-065 M6 x 90MM (3.5") FOR BASS DRUMS (1) ..... 4.50  
 T-066 M6 x 115MM (4.5") FOR BASS DRUMS (1) ..... 4.00  
 T-066X W7/32 x 110MM (4.33") FOR VML BASS DRUMS (1) ..... 4.00  
 TR-5100 W7/32 x 110MM (4.33") FOR VBL-VBA-VB-FZH-EXX (1) ..... 4.00  
 SPT-5047 W7/32 x 47MM SPIN-TIGHT STAINLESS STEEL (1) ..... 22.00  
 SPT-4SPK SPIN-TIGHT STARTER PACK (SPT-5047 x 1, K-180 KEY x 1) ..... 80.00  
 SPT-6PK SPIN-TIGHT TENSION ROD PACK (SPT-5047 x 6) ..... 84.00  
 SST-5028/6 W7/32 x 28MM (1.1") STAINLESS STEEL (6/PACK) ..... 30.00  
 SST-5035/6 W7/32 x 35MM (1.38") STAINLESS STEEL (6/PACK) ..... 30.00  
 SST-5038/6 W7/32 x 38MM (1.5") STAINLESS STEEL (6/PACK) ..... 30.00  
 SST-5042/6 W7/32 x 42MM (1.65") STAINLESS STEEL (6/PACK) ..... 30.00  
 SST-5047/6 W7/32 x 47MM (1.85") STAINLESS STEEL (6/PACK) ..... 30.00  
 SST-5052/6 W7/32 x 52MM (2") STAINLESS STEEL (6/PACK) ..... 30.00  
 SST-6054 M6 x 54MM (2.12") SS FOR PIPE SNARE DRUMS (1) ..... 6.00  
 SST-6115 M6 x 115MM (4.5") SS FOR BASS DRUMS (1) ..... 11.00  
 NLW-12B/12 NYLON WASHERS BLACK (12/PACK) ..... 6.00  
 MTW-12/12 METAL WASHERS (12/PACK) ..... 4.00  
 S-61/12 M5.8 SWIVEL NUT NICKEL PLATED BRASS (12/PACK) ..... 7.00  
 S-71/12 M6 SWIVEL NUT NICKEL PLATED BRASS (12/PACK) ..... 9.00  
 TL-20/10 TENSION ROD LOCK NUTS (10/PACK) ..... 27.00  
 TNK-10N/10 TENSION KEEPER (10/PACK) ..... 11.00

## LUGS

BRL-100 MW/REFERENCE SMALL (SPACING 39MM) ..... \$19.00  
 BRL-300 MW/REFERENCE LARGE (SPACING 51MM) ..... 20.00  
 BRL-55 MW/REFERENCE FOR 5" & 5.5" SNARE DRUMS (SPACING 51MM) ..... 28.00  
 BRL-65 MW/REFERENCE FOR 6.5" SNARE DRUMS (SPACING 88MM) ..... 32.00  
 ARL-55 ARCH TUBE LUG FOR 5"/5.5" SNARE DRUMS (SPACING 51MM) ..... 30.00  
 ARL-65 ARCH TUBE LUG FOR 6.5" SNARE DRUMS (SPACING 88MM) ..... 41.00  
 STL-55 SWIVEL TUBE LUG FOR MASTERS PREMIUM 5.5" SNARE DRUMS ..... 37.00  
 STL-55L SWIVEL TUBE LUG FOR REFERENCE PURE 5.5" SNARE DRUMS ..... 37.00  
 STL-65 SWIVEL TUBE LUG RF PURE & MASTERS PREMIUM 6.5" SNARE ..... 39.00  
 NEW STL-100 SWIVEL LUG - MW & HYBRID EXOTICS SNARE DRUMS ..... 12.00  
 STL-150 SWIVEL TUBE LUG FOR REFERENCE PURE TOMS ..... 32.00  
 STL-300 SWIVEL TUBE LUG FOR REFERENCE PURE BASS DRUMS ..... 37.00  
 CL-100 MASTERS MCX SMALL (SPACING 39MM) ..... 9.00  
 CL-250 MASTERS MCX LARGE (SPACING 51MM) ..... 12.00  
 CL-05 CLASSIC LUG FOR 3" - 4" SNARE DRUMS (SPACING 20MM) ..... 8.00  
 CL-55 BRIDGE LUG FOR 5" & 5.5" SNARE DRUMS (SPACING 51MM) ..... 12.00  
 CL-65 BRIDGE LUG FOR 6.5" SNARE DRUMS (SPACING 88MM) ..... 13.00  
 TB-40 TUBE LUG FOR 4" SNARE DRUMS (SPACING 33MM) ..... 21.00  
 TB-50 TUBE LUG FOR 5" SNARE DRUMS (SPACING 51MM) ..... 23.00  
 TB-55 TUBE LUG FOR 5.5" SNARE DRUMS (SPACING 63MM) ..... 24.00  
 TB-65 TUBE LUG FOR 6.5" SNARE DRUMS (SPACING 88MM) ..... 27.00  
 TB-80 TUBE LUG FOR 8" SNARE DRUMS (SPACING 127MM) ..... 27.00  
 TLS-55/C VISION FOR 5.5" SNARE DRUMS (SPACING 51MM) ..... 13.00  
 TLT-100/C VISION SMALL (SPACING 39MM) ..... 9.00  
 TLB-300/C VISION LARGE (SPACING 51MM) ..... 13.00  
 NSL-55/C FORUM FZH SNARE DRUM (SPACING 51MM) ..... 8.00  
 NSL-100/C FORUM FZH SMALL (SPACING 24MM) ..... 6.00  
 NSL-300/C FORUM FZH LARGE (SPACING 32MM) ..... 7.00  
 FT-35 FREE FLOATING FOR 3.5" ..... 9.00  
 FT-50 FREE FLOATING FOR 5" ..... 12.00  
 FT-65 FREE FLOATING FOR 6.5" ..... 14.00  
 NEL-55/C EXPORT EXX SNARE DRUM (SPACING 51MM) ..... 8.00  
 NEL-100/C EXPORT EXX SMALL (SPACING 24MM) ..... 5.00  
 NEL-300/C EXPORT EXX LARGE (SPACING 32MM) ..... 7.00

## RUBBER FEET

R-26N/3 D-2500/BR, D-1000N/SN/SPN (3) ..... \$21.00  
 R-22N/3 BC-2030, BC-1030, C-1030, S-1030, S-1030L, T/TC-1030 (3) ..... 21.00  
 R-20N/3 D-930 (3) ..... 21.00  
 R-10/3 C-1000AC, C-1000SC (3) ..... 22.00  
 RB-8 H-930, BC-930, C-930, T-930, TC-930 (1) ..... 11.00  
 RB-9 S-900, S-930, S930D (1) ..... 7.00  
 RB16 S-1030LS, D-730S (1) ..... 7.00  
 RB22 H-830, BC-830, C-830, S-830 (1) ..... 7.00  
 PL-34 D-790 (1) ..... 2.00

## MUFFLERS

OM-1 CLIP-ON MUFFLER FOR SNARE DRUMS & TOMS ..... \$23.00

# HOOPS

## BASS DRUM HOOPS- WOOD

|           |  |          |
|-----------|--|----------|
| RIM-18W   | 18" FOR RF/RFP/MASTERS MAPLE (SPECIFY COLOR) | \$150.00 |
| RIM-20W   | 20" FOR RF/RFP/MASTERS MAPLE (SPECIFY COLOR) | 168.00   |
| RIM-22W   | 22" FOR RF/RFP/MASTERS MAPLE (SPECIFY COLOR) | 178.00   |
| RIM-24W   | 24" FOR RF/RFP/MASTERS MAPLE (SPECIFY COLOR) | 191.00   |
| MCXRIM-18 | 18" FOR MCX (SPECIFY COLOR)                  | 127.00   |
| MCXRIM-20 | 20" FOR MCX (SPECIFY COLOR)                  | 138.00   |
| MCXRIM-22 | 22" FOR MCX (SPECIFY COLOR)                  | 151.00   |
| MCXRIM-24 | 24" FOR MCX (SPECIFY COLOR)                  | 162.00   |
| BCXRIM-20 | 20" FOR BCX (SPECIFY COLOR)                  | 95.00    |
| BCXRIM-22 | 22" FOR BCX (SPECIFY COLOR)                  | 127.00   |
| BCXRIM-24 | 24" FOR BCX (SPECIFY COLOR)                  | 150.00   |
| SSCRIM-20 | 20" FOR SSC (SPECIFY COLOR)                  | 111.00   |
| SSCRIM-22 | 22" FOR SSC (SPECIFY COLOR)                  | 122.00   |
| SSCRIM-24 | 24" FOR SSC (SPECIFY COLOR)                  | 129.00   |
| VBL-20HP  | 20" FOR VBL (SPECIFY COLOR)                  | 111.00   |
| VBL-22HP  | 22" FOR VBL (SPECIFY COLOR)                  | 122.00   |
| VBL-24HP  | 24" FOR VBL (SPECIFY COLOR)                  | 129.00   |
| EXL-20HP  | 20" FOR EXL (SPECIFY COLOR)                  | 111.00   |
| EXL-22HP  | 22" FOR EXL (SPECIFY COLOR)                  | 111.00   |
| EXL-24HP  | 24" FOR EXL (SPECIFY COLOR)                  | 129.00   |
| EXX-20HP  | 20" FOR EXX (SPECIFY COLOR)                  | 101.00   |
| EXX-22HP  | 22" FOR EXX (SPECIFY COLOR)                  | 101.00   |
| EXX-24HP  | 24" FOR EXX (SPECIFY COLOR)                  | 111.00   |

## DIE CAST HOOPS

|           |                               |         |
|-----------|-------------------------------|---------|
| DC-0805   | 8" 5 ROD                      | \$58.00 |
| DC-1006   | 10" 6 ROD                     | 63.00   |
| DC-1206   | 12" 6 ROD                     | 69.00   |
| DC-1306   | 13" 6 ROD                     | 74.00   |
| DC-1408   | 14" 8 ROD                     | 79.00   |
| DC-1408S  | 14" 8 ROD BOTTOM              | 84.00   |
| DC-1410   | 14" 10 ROD BATTER SIDE        | 79.00   |
| DC-1410S  | 14" 10 ROD SNARE SIDE         | 79.00   |
| DC-1410SG | 14" 10 ROD SNARE SIDE w/GUARD | 95.00   |
| DC-1508   | 15" 8 ROD                     | 84.00   |
| DC-1608   | 16" 8 ROD                     | 90.00   |
| DC-1808   | 18" 8 ROD                     | 100.00  |

## FAT TONE HOOPS

|          |                       |         |
|----------|-----------------------|---------|
| FH-0805  | 8" 5 ROD              | \$37.00 |
| FH-1006  | 10" 6 ROD             | 37.00   |
| FH-1206  | 12" 6 ROD             | 37.00   |
| FH-1306  | 13" 6 ROD             | 38.00   |
| FH-1308  | 13" 8 ROD             | 38.00   |
| FH-1308S | 13" 8 ROD SNARE SIDE  | 38.00   |
| FH-1408  | 14" 8 ROD             | 41.00   |
| FH-1410  | 14" 10 ROD            | 41.00   |
| FH-1410S | 14" 10 ROD SNARE SIDE | 41.00   |
| FH-1508  | 15" 8 ROD             | 41.00   |
| FH-1608  | 16" 8 ROD             | 47.00   |
| FH-1808  | 18" 8 ROD             | 47.00   |

## SUPERHOOP II - 2.3MM

|           |                               |         |
|-----------|-------------------------------|---------|
| SH-0604   | 6" 4 ROD                      | \$22.00 |
| SH-0805   | 8" 5 ROD                      | 23.00   |
| SH-1006   | 10" 6 ROD                     | 23.00   |
| SH-1006S  | 10" 6 ROD SNARE SIDE          | 23.00   |
| SH-1206   | 12" 6 ROD                     | 23.00   |
| SH-1208   | 12" 8 ROD MARCHING            | 26.00   |
| SH-1208S  | 12" 8 ROD SNARE SIDE          | 26.00   |
| SH-1306   | 13" 6 ROD                     | 29.00   |
| SH-1308   | 13" 8 ROD MARCHING            | 29.00   |
| SH-1308S  | 13" 8 ROD SNARE SIDE          | 29.00   |
| SH-1308SG | 13" 8 ROD SNARE SIDE w/GUARD  | 29.00   |
| SH-1310B  | 13" 10 ROD                    | 29.00   |
| SH-1310SG | 13" 10 ROD SNARE SIDE w/GUARD | 29.00   |
| SH-1408   | 14" 8 ROD BATTER SIDE         | 35.00   |
| SH-1408S  | 14" 8 ROD SNARE SIDE          | 35.00   |
| SH-1410B  | 14" 10 ROD BATTER SIDE        | 35.00   |
| SH-1410S  | 14" 10 ROD SNARE SIDE         | 35.00   |
| SH-1410SG | 14" 10 ROD SNARE SIDE w/GUARD | 35.00   |
| SH-1412B  | 14" 12 ROD SNARE SIDE         | 35.00   |
| SH-1412SG | 14" 12 ROD SNARE SIDE w/GUARD | 35.00   |
| SH-1508   | 15" 8 ROD                     | 35.00   |
| SH-1608   | 16" 8 ROD                     | 41.00   |
| SH-1610B  | 16" 10 ROD                    | 41.00   |
| SH-1610SG | 16" 10 ROD SNARE SIDE w/GUARD | 41.00   |
| SH-1808   | 18" 8 ROD                     | 41.00   |

## REGULAR HOOPS - 1.6MM

|          |                       |         |
|----------|-----------------------|---------|
| RH-0804  | 8" 4 ROD              | \$21.00 |
| RH-1006  | 10" 6 ROD             | 21.00   |
| RH-1206  | 12" 6 ROD             | 21.00   |
| RH-1306  | 13" 6 ROD             | 26.00   |
| RH-1408  | 14" 8 ROD BATTER SIDE | 37.00   |
| RH-1408S | 14" 8 ROD SNARE SIDE  | 37.00   |
| RH-1608  | 16" 8 ROD             | 46.00   |
| RH-1808  | 18" 8 ROD             | 47.00   |

## SINGLE FLANGE HOOPS

|         |                        |         |
|---------|------------------------|---------|
| SF-13   | 13" BATTER SIDE        | \$42.00 |
| SF-13SG | 13" SNARE SIDE w/GUARD | 42.00   |
| SF-14   | 14" BATTER SIDE        | 42.00   |
| SF-14S  | 14" SNARE SIDE         | 42.00   |
| SF-14SG | 14" SNARE SIDE w/GUARD | 42.00   |

# HEADS

## BASS DRUM HEADS w/LOGO - FRONT

| SIZE | "MASTERWORKS" COATED P3 | "REFERENCE" COATED P3 | "MASTERS" CLEAR P3 | "MASTERS" COATED P3 | "MASTERS" EBONY P3 | "PROTONE" EBONY w/PERIMETER EQ | "PROTONE" COATED w/PERIMETER EQ | BLACK BEAT        |
|------|-------------------------|-----------------------|--------------------|---------------------|--------------------|--------------------------------|---------------------------------|-------------------|
| 18"  | MWH-18PL \$131.00       | P3-1118PL-RF \$71.80  | P3-1318PL \$71.80  | P3-1118PL \$72.30   | P3-1018PL \$82.00  | PTH-18PL \$34.00               | PTH-18CEQPL \$34.00             | EB-18BDPL \$27.00 |
| 20"  | MWH-20PL 131.50         | P3-1120PL-RF 73.80    | P3-1320PL 73.80    | P3-1120PL 73.80     | P3-1020PL 86.10    | PTH-20PL 36.00                 | PTH-20CEQPL 36.00               | EB-20BDPL 44.00   |
| 22"  | MWH-22PL 145.50         | P3-1122PL-RF 79.20    | P3-1322PL 79.20    | P3-1122PL 80.00     | P3-1022PL 90.50    | PTH-22PL 38.00                 | PTH-22CEQPL 38.00               | EB-22BDPL 51.00   |
| 24"  | MWH-24PL 145.00         | P3-1124PL-RF 84.80    | P3-1324PL 84.80    | P3-1124PL 84.80     | P3-1024PL 95.50    | PTH-24PL 43.00                 | PTH-24CEQPL 43.00               | EB-24BDPL 55.00   |

## BASS DRUM HEADS - BATTER

| SIZE | "REFERENCE" CLEAR P3 | CLEAR P3          | PROTONE CLEAR w/PERIMETER EQ | PROTONE COATED w/PERIMETER EQ |
|------|----------------------|-------------------|------------------------------|-------------------------------|
| 18"  | P3-1318PL-RF \$71.80 | P3-1318PP \$71.80 | PTH-18EQ \$34.00             | PTH-18CEQ \$34.00             |
| 20"  | P3-1320PL-RF 73.80   | P3-1320PP 73.80   | PTH-20EQ 36.00               | PTH-20CEQ 36.00               |
| 22"  | P3-1322PL-RF 79.20   | P3-1322PP 79.20   | PTH-22EQ 38.00               | PTH-22CEQ 38.00               |
| 24"  | P3-1324PL-RF 84.80   | P3-1324PP 84.80   | PTH-24EQ 43.00               | PTH-24CEQ 43.00               |

## TOM HEADS

| SIZE | "REFERENCE" EMPEROR CLEAR | PROTONE CLEAR 2-PLY | PROTONE CLEAR 1-PLY | PROTONE COATED 1-PLY |
|------|---------------------------|---------------------|---------------------|----------------------|
| 8"   | BE-0308-PL-RF \$24.60     | PTH-08D \$17.00     | PTH-08 \$8.00       | PTH-08C \$12.00      |
| 10"  | BE-0310-PL-RF 25.90       | PTH-10D 19.00       | PTH-10 9.00         | PTH-10C 13.00        |
| 12"  | BE-0312-PL-RF 27.70       | PTH-12D 21.00       | PTH-12 11.00        | PTH-12C 13.00        |
| 13"  | BE-0313-PL-RF 28.40       | PTH-13D 23.00       | PTH-13 11.00        | PTH-13C 15.00        |
| 14"  | BE-0314-PL-RF 31.00       | PTH-14D 24.00       | PTH-14 12.00        | PTH-14C 16.00        |
| 15"  | BE-0315-PL-RF 32.50       | PTH-15D 25.00       | PTH-15 12.00        | PTH-15C 18.00        |
| 16"  | BE-0316-PL-RF 34.10       | PTH-16D 32.00       | PTH-16 13.00        | PTH-16C 21.00        |
| 18"  | BE-0318-PL-RF 42.80       | PTH-18D 34.00       | PTH-18 17.00        | PTH-18C 24.00        |

| SIZE | MESH HEADS    | MESH HEAD PACK                  |
|------|---------------|---------------------------------|
| 8"   | MFH-08 \$9.00 | MFH-1222PK \$89.00              |
| 10"  | MFH-10 12.00  | 5 PACK FITS 12" 13" 14" 16" 22" |
| 12"  | MFH-12 13.00  |                                 |
| 13"  | MFH-13 14.00  |                                 |
| 14"  | MFH-14 15.00  |                                 |
| 16"  | MFH-16 18.00  |                                 |
| 18"  | MFH-18 16.50  |                                 |
| 20"  | MFH-20B 28.00 |                                 |
| 22"  | MFH-22B 33.00 |                                 |

## SNARE DRUM HEADS

| SIZE | "REFERENCE" WINDOW COATED AMBASSADOR | COATED BATTER | SNARE HEAD     |
|------|--------------------------------------|---------------|----------------|
| 13"  | BA-0113-PL-RF \$28.40                | WA-13 \$13.00 | SS-13S \$16.00 |
| 14"  | BA-0114-PL-RF 31.00                  | WA-14 13.00   | SS-14S 18.00   |

## SIGNATURE SERIES CONGAS & BONGOS

### BOBBY ALLENDE SIGNATURE CONGAS AND BONGOS

|                |           |   |                      |          |
|----------------|-----------|---|----------------------|----------|
| PCF-110DXBA618 | 11"       | FIBERGLASS QUINTO 28" TALL - REMO FIBERSKYN3 HEADS, LOW-RIDER RIMS, POLISHED STEEL HARDWARE | #618 BRISA TROPICAL  | \$680.00 |
| PCF-117DXBA618 | 11 3/4"   | FIBERGLASS CONGA 28" TALL - REMO FIBERSKYN3 HEADS, LOW-RIDER RIMS, POLISHED STEEL HARDWARE  | #618 BRISA TROPICAL  | 790.00   |
| PCF-125DXBA618 | 12 1/2"   | FIBERGLASS TUMBA 28" TALL - REMO FIBERSKYN3 HEADS, LOW-RIDER RIMS, POLISHED STEEL HARDWARE  | #618 BRISA TROPICAL  | 845.00   |
| PBF-300DXBA618 | 7" & 8.5" | FIBERGLASS BONGOS - REMO FIBERSKYN3 HEADS, LOW-RIDER RIMS, POLISHED STEEL HARDWARE          | #618 BRISA TROPICAL  | 470.00   |
| PCF-110DXBA620 | 11"       | FIBERGLASS QUINTO 28" TALL - REMO FIBERSKYN3 HEADS, LOW-RIDER RIMS, POLISHED STEEL HARDWARE | #620 CAFE' CON LECHE | 680.00   |
| PCF-117DXBA620 | 11 3/4"   | FIBERGLASS CONGA 28" TALL - REMO FIBERSKYN3 HEADS, LOW-RIDER RIMS, POLISHED STEEL HARDWARE  | #620 CAFE' CON LECHE | 790.00   |
| PCF-125DXBA620 | 12 1/2"   | FIBERGLASS TUMBA 28" TALL - REMO FIBERSKYN3 HEADS, LOW-RIDER RIMS, POLISHED STEEL HARDWARE  | #620 CAFE' CON LECHE | 845.00   |
| PBF-300DXBA620 | 7" & 8.5" | FIBERGLASS BONGOS - REMO FIBERSKYN3 HEADS, LOW-RIDER RIMS, POLISHED STEEL HARDWARE          | #620 CAFE' CON LECHE | 470.00   |

### RICHIE FLORES SIGNATURE CONGAS & BONGOS

|                |         |  |  |          |
|----------------|---------|--|--|----------|
| PCW-110DXRF527 | 11"     | THAI OAK QUINTO w/HAND-SELECTED BUFFALO SKINS, CHROME HW         | - #527 LUNAR ECLIPSE COLOR-CHANGING FINISH | \$743.00 |
| PCW-117DXRF527 | 11 3/4" | THAI OAK CONGA w/HAND-SELECTED BUFFALO SKINS, CHROME HW          | - #527 LUNAR ECLIPSE COLOR-CHANGING FINISH | 854.00   |
| PCW-125DXRF527 | 12 1/2" | THAI OAK TUMBA w/HAND-SELECTED BUFFALO SKINS, CHROME HW          | - #527 LUNAR ECLIPSE COLOR-CHANGING FINISH | 921.00   |
| PBW-300DXRF527 | 7" & 9" | 7" & 9" THAI OAK BONGOS w/HAND-SELECTED BUFFALO SKINS, CHROME HW | - #527 LUNAR ECLIPSE COLOR-CHANGING FINISH | 555.00   |

## ELITE SERIES CONGAS & BONGOS

|                          |         |   |  |            |
|--------------------------|---------|---|--|------------|
| <b>NEW</b> PCW-110DXG535 | 11"     | THAI OAK QUINTO w/SELF-ALIGNING WASHER SYSTEM | #535 SATIN BLACK W/GOLD HARDWARE       | \$1,055.00 |
| <b>NEW</b> PCW-117DXG535 | 11.75"  | THAI OAK CONGA w/SELF-ALIGNING WASHER SYSTEM  | #535 SATIN BLACK W/GOLD HARDWARE       | 1,165.00   |
| <b>NEW</b> PCW-125DXG535 | 12.5"   | THAI OAK TUMBA w/SELF-ALIGNING WASHER SYSTEM  | #535 SATIN BLACK W/GOLD HARDWARE       | 1,220.00   |
| <b>NEW</b> PBW-300DXG535 | 7"/9"   | THAI OAK BONGOS w/SELF-ALIGNING WASHER SYSTEM | #535 SATIN BLACK W/GOLD HARDWARE       | 732.00     |
| PCW-110DX532             | 11"     | THAI OAK QUINTO w/SELF-ALIGNING WASHER SYSTEM | #532 CHERRY EUCALYPTUS W/GOLD HARDWARE | 1,055.00   |
| PCW-117DX532             | 11.75"  | THAI OAK CONGA w/SELF-ALIGNING WASHER SYSTEM  | #532 CHERRY EUCALYPTUS W/GOLD HARDWARE | 1,165.00   |
| PCW-125DX532             | 12.5"   | THAI OAK TUMBA w/SELF-ALIGNING WASHER SYSTEM  | #532 CHERRY EUCALYPTUS W/GOLD HARDWARE | 1,220.00   |
| PBW-300DX532             | 7"/9"   | THAI OAK BONGOS w/SELF-ALIGNING WASHER SYSTEM | #532 CHERRY EUCALYPTUS W/GOLD HARDWARE | 732.00     |
| PCF-110DXA641            | 11"     | FIBERGLASS QUINTO 28" TALL w/LOW-RIDER RIMS   | #641 BLUE SPARKLE BURST                | 680.00     |
| PCF-117DXA641            | 11.75"  | FIBERGLASS CONGA 28" TALL w/ LOW-RIDER RIMS   | #641 BLUE SPARKLE BURST                | 790.00     |
| PCF-125DXA641            | 12.5"   | FIBERGLASS TUMBA 28" TALL w/ LOW-RIDER RIMS   | #641 BLUE SPARKLE BURST                | 845.00     |
| PBF-300DXA641            | 7"/8.5" | FIBERGLASS BONGOS w/LOW-RIDER RIMS            | #641 BLUE SPARKLE BURST                | 470.00     |

## HAVANA SERIES CONGAS & BONGOS

|           |        |   |                  |          |
|-----------|--------|---|------------------|----------|
| PCF-110HV | 11"    | FIBERGLASS "FAT BELLY" QUINTO 30" TALL w/LOW-RIDER RIMS | #644 LIQUID GOLD | \$680.00 |
| PCF-117HV | 11.75" | FIBERGLASS "FAT BELLY" CONGA 30" TALL w/LOW-RIDER RIMS  | #644 LIQUID GOLD | 790.00   |
| PCF-125HV | 12.5"  | FIBERGLASS "FAT BELLY" TUMBA 30" TALL w/LOW-RIDER RIMS  | #644 LIQUID GOLD | 845.00   |
| PBF-300HV | 7"/9"  | FIBERGLASS BONGOS w/LOW-RIDER RIMS                      | #644 LIQUID GOLD | 470.00   |

## FOLKLORIC SERIES CONGAS / BONGOS / BATA

### TRADITIONAL OAK CONGAS & BONGOS

|              |         |                               |          |
|--------------|---------|-------------------------------|----------|
| PCW-110FC526 | 11"     | QUINTO #526 CRIMSON SUNRISE   | \$775.00 |
| PCW-117FC526 | 11.75"  | SEGUNDO #526 CRIMSON SUNRISE  | 830.00   |
| PCW-125FC526 | 12.5"   | TUMBADOR #526 CRIMSON SUNRISE | 885.00   |
| PBW-300FC526 | 7"/8.5" | BONGOS #526 CRIMSON SUNRISE   | 440.00   |

### BATAS - THAI OAK

|           |                               |          |
|-----------|-------------------------------|----------|
| PBA-50511 | OCONCOLO - SMALL #511 NATURAL | \$775.00 |
| PBA-60511 | ITOTELE - MEDIUM #511 NATURAL | 830.00   |
| PBA-70511 | IYA - LARGE #511 NATURAL      | 945.00   |

## PRIMERO PRO CONGAS & BONGOS

### THAI OAK CONGAS & BONGOS

|           |              |                               |          |
|-----------|--------------|-------------------------------|----------|
| PWC-302DX | 10"/11"      | SET w/o STANDS                | \$940.00 |
| PWC-202DX | 11.75"/12.5" | SET w/o STANDS                | 765.00   |
| PWB-100DX | 7"/8.5"      | BONGOS w/ELITE CROWN/HEADS/HW | 275.00   |

COLORS: #511 NATURAL, #521 MIDNIGHT FADE, #523 CARBON VAPOR

### FIBERGLASS CONGAS & BONGOS

|           |              |                               |          |
|-----------|--------------|-------------------------------|----------|
| PFC-302DX | 11.75"/12.5" | SET w/o STANDS                | \$825.00 |
| PFC-202DX | 10"/11"      | SET w/o STANDS                | 635.00   |
| PFB-100DX | 7"/8.5"      | BONGOS w/ELITE CROWN/HEADS/HW | 305.00   |

COLORS: #621 WINE RED MARBLE, #626 GOLD MARBLE

## PRIMERO CONGAS & BONGOS

### THAI OAK CONGAS & BONGOS

CONTOUR CROWNS & BLACK POWDER COATED HW

|            |         |  |          |
|------------|---------|--|----------|
| PWC-202511 | 10"/11" | SET w/o STANDS #511 NATURAL                | \$665.00 |
| PWC-203511 | 10"/11" | SET w/PC-300W STAND #511 NATURAL           | 785.00   |
| PWC-204511 | 10"/11" | SET w/PC-100P & PC110P STANDS #511 NATURAL | 815.00   |
| PWB-67511  | 6"/7"   | BONGOS #511 NATURAL                        | 175.00   |

### FIBERGLASS CONGAS & BONGOS

CONTOUR CROWNS & BLACK POWDER COATED HW

|            |         |   |          |
|------------|---------|---|----------|
| PFC-202602 | 10"/11" | SET w/o STANDS #602 BISTRE BLACK                | \$479.00 |
| PFC-202631 | 10"/11" | SET w/o STANDS #631 EBONY                       | 479.00   |
| PFC-203602 | 10"/11" | SET w/PC-300W STAND #602 BISTRE BLACK           | 549.00   |
| PFC-204602 | 10"/11" | SET w/PC-100P & PC110P STANDS #602 BISTRE BLACK | 579.00   |
| PFB-100602 | 6"/7"   | BONGOS #602 BISTRE BLACK                        | 175.00   |
| PFB-100631 | 6"/7"   | BONGOS #631 EBONY                               | 175.00   |

## TRAVEL CONGAS

|          |        |                                    |          |
|----------|--------|------------------------------------|----------|
| PTC-1100 | 11"    | w/REMO FIBERSKYN3 HEAD - 3.5" DEEP | \$410.00 |
| PTC-1175 | 11.75" | w/REMO FIBERSKYN3 HEAD - 3.5" DEEP | 440.00   |
| PTC-1250 | 12.5"  | w/REMO FIBERSKYN3 HEAD - 3.5" DEEP | 475.00   |



## CAJONS

|                       |  |                 |
|-----------------------|--|-----------------|
| <b>NEW</b> PBC-1914M3 | MACH 3 CAJON w/ 3 ISOLATED PLAYING ZONES 100% BIRCH (USA) .....  | <b>\$759.00</b> |
| <b>NEW</b> PBC-511ABC | AFTERBURNER CAJON W/DUAL REAR BASS PORTS 100% BIRCH (USA) .....  | <b>415.00</b>   |
| PBC-1914SBS           | SONIC BOOM BUZZ CAJON w/SNARES, BASS PORT & ANGLED WALNUT FRONT PLATE (USA) .....  | <b>559.00</b>   |
| PBC-1914SB            | SONIC BOOM CAJON w/BASS PORT & ANGLED FRONT PLATE (USA) .....  | <b>499.00</b>   |
| <b>NEW</b> PCJ-650CG  | CENTIGRADE CAJON w/100 DEGREES OF TILT <b>#650 MANGO CHERRY BURST</b> .....  | <b>499.00</b>   |
| PCJ-IC645             | INNER CIRCLE MULTI-FUNCTION CAJON/CONGA - INCLUDES STRAP <b>#645 TEQUILA SUNRISE, #648 BURNT ORANGE TURBO STRIPE</b> ..... | <b>499.00</b>   |
| PCJ-3000B             | THE WEDGE TRI-SIDE CAJON - ERGO SHAPE FOR EASY PLAYING .....   | <b>499.00</b>   |
| PBC-509JD             | JESUS DIAS SIGNATURE RADIAL EDGE CAJON 12.4"x12.4"x19.4" <b>#509 ARTISAN ROSEWOOD</b> .....                                | <b>443.00</b>   |
| PBC-512TF             | TWO-FACE CAJON - 3MM & 5MM WOOD FACES FOR TWO DIFFERENT SOUNDS 18.8"x12.4"x12.4" .....                                     | <b>419.00</b>   |
| PCJ-647CYC            | CYCLONE CAJON FIBERGLASS BODY w/CURVED BACK & BOOM PORT <b>#647 DARK CHOCOLATE</b> .....                                   | <b>399.00</b>   |
| PFC-629S              | CUBE CAJON w/TWO-HEIGHT STAND - 5 DIFFERENT TONES 12.62"x12.62"x12.62" <b>#648 CARUBINGA</b> .....                         | <b>399.00</b>   |
| PCJ-633BB630          | BOOM BOX FIBERGLASS CAJON w/PORTED CHAMBER FOR SUPER-LOW BASS 12"x12"x18.9" <b>#630 RED SPARKLE</b> .....                  | <b>399.00</b>   |
| PCJ-633BT             | BRUSH BEAT BOOM BOX FIBERGLASS CAJON w/PORTED CHAMBER FOR SUPER-LOW BASS 12"x12"x18.9" <b>BLACK/WHITE FINISH</b> .....     | <b>399.00</b>   |
| PCJ-633BB             | BOOM BOX FIBERGLASS CAJON w/PORTED CHAMBER FOR SUPER-LOW BASS 12"x12"x18.9" <b>#633 ARTISAN RED MAHOGANY</b> .....         | <b>332.00</b>   |
| PCJ-629               | JINGLE BOX CAJON 12"x12"x18.9" <b>#629 CARUBINGA</b> .....   | <b>332.00</b>   |
| PBC-507JC             | JINGLE BOX CAJON - WOOD w/SNARES .....   | <b>332.00</b>   |
| PTCJ-1265             | TRAVEL CAJON 12"x6.5" .....  | <b>310.00</b>   |
| PBC-507               | BOX CAJON 12"x12"x18.9" <b>#507 GYPSY BROWN</b> .....  | <b>245.00</b>   |
| PBC512CC              | CLUB CAJON - WOOD w/PORTED CHAMBER & FIXED SNARES .....  | <b>189.00</b>   |
| PFB-300               | FUN BOX CAJON - IDEAL FOR THE TRAP PROGRAM 10"x9.45"x13.4" .....   | <b>180.00</b>   |

## DJEMBES

|              |   |                 |
|--------------|---|-----------------|
| PJW-140R533  | 14" THAI OAK EZ TUNE ROPE LOOK w/MECHANICAL TUNING, GOAT SKIN HEADS, STRAP INCLUDED <b>#533 GLOSS BLACK w/RED ROPES</b> .....   | <b>\$610.00</b> |
| PJW-125R533  | 12.5" THAI OAK EZ TUNE ROPE LOOK w/MECHANICAL TUNING, GOAT SKIN HEADS, STRAP INCLUDED <b>#533 GLOSS BLACK w/RED ROPES</b> ..... | <b>565.00</b>   |
| PJF-350RX632 | 14" FIBERGLASS EZ TUNE ROPE LOOK w/MECHANICAL TUNING, GOAT SKIN HEADS, STRAP INCLUDED <b>#632 CRANBERRY FADE</b> .....          | <b>515.00</b>   |
| PJF-320RX632 | 12.0" FIBERGLASS EZ TUNE ROPE LOOK w/MECHANICAL TUNING, GOAT SKIN HEADS, STRAP INCLUDED <b>#632 CRANBERRY FADE</b> .....        | <b>405.00</b>   |
| PJW-340511   | 12.5" THAI OAK w/CONTOUR CROWN, GOAT SKIN HEADS, STRAP INCLUDED <b>#511 NATURAL</b> .....                                       | <b>885.00</b>   |
| PJF-320602   | 12.5" FIBERGLASS w/CONTOUR CROWN, GOAT SKIN HEADS, STRAP INCLUDED <b>#602 BISTRE BLACK</b> .....                                | <b>550.00</b>   |
| PJF-350602   | 14" FIBERGLASS w/CONTOUR CROWN, GOAT SKIN HEADS, STRAP INCLUDED <b>#602 BISTRE BLACK</b> .....                                  | <b>770.00</b>   |
| PJF-310602   | 9.5" FIBERGLASS <b>#602 BISTRE BLACK</b> .....  | <b>329.00</b>   |
| PFD-300      | FUN DRUM LIGHTWEIGHT FIBERGLASS DJEMBE w/SHOULDER STRAP, GREAT FOR THE TRAP PROGRAM .....                                       | <b>220.00</b>   |

## FRAME DRUMS

|          |  |                |           |  |                 |
|----------|--|----------------|-----------|--|-----------------|
| PHC-STRP | HIP CLIPZ STRAP w/CLIPS .....            | <b>\$32.00</b> | PFR-0818C | SET: 8",10",12",14",16",18" TUNABLE FRAME DRUMS (COATED HEADS) ..... | <b>\$499.00</b> |
| PHC-SNR  | HIP CLIPZ SNARE SLAP .....               | <b>49.00</b>   | PFR-0818  | SET: 8",10",12",14",16",18" TUNABLE FRAME DRUMS (SMOOTH HEADS) ..... | <b>499.00</b>   |
| PHC-PK   | HIP CLIPZ STRAP & SNARE SLAP (SET) ..... | <b>79.00</b>   | PFR-14C   | 14" TUNABLE FRAME DRUM w/COATED HEAD .....                           | <b>89.00</b>    |
|          |  |                | PFR-14HK  | 14" THE "HIPKIT" w/HIP CLIPZ STRAP & SNARE SLAP .....                | <b>165.00</b>   |

## TIMBALES

|            |  |                 |
|------------|--|-----------------|
| ETE-1415MQ | STEEL 14x7"/15x7" MARC QUINONES 5 LUGS, QUICK ATTACH COWBELL POST, REMO AMBASSADORS, DBL BR. TILTING STAND, PBL-30 CLAVE BLOCK ..... | <b>\$880.00</b> |
| PTE-1415MQ | STEEL 14x7"/15x7" MARC QUINONES PRIMERO BLACK POWDER COATED FINISH, 5 LUGS, PT-800W TILTING STAND .....                              | <b>739.00</b>   |
| PTE-1415DX | STEEL 14x7"/15x7" PRIMERO PRO w/TILTING STAND .....  | <b>615.00</b>   |
| PTS-5134   | STEEL 13x6.5"/14x6.5" PRIMERO w/TILTING STAND, STICKS & COWBELL .....  | <b>579.00</b>   |
| PTE-1336   | STEEL 13x7" PRIMERO w/PPS-36 MOUNTING CLAMP .....  | <b>240.00</b>   |
| PTE-3131   | STEEL 13x3" PRIMERO FLAT TIMBALE w/I.S.S. .....  | <b>189.00</b>   |

## STANDS

|           |  |                 |
|-----------|--|-----------------|
| PC-3000TW | QUICK STAND DOUBLE CONGA STAND w/CASE .....    | <b>\$285.00</b> |
| PC-900    | ALL-FIT CONGA STAND ADJ. HEIGHT & TILT .....   | <b>150.00</b>   |
| PC-300W   | QUICK RELEASE DOUBLE CONGA STAND .....         | <b>120.00</b>   |
| PC-2500   | ULTRA LITE BASKET STAND .....                  | <b>165.00</b>   |
| PC-100P   | BASKET STAND FOR 10" PRIMERO ADJ. HEIGHT ..... | <b>75.00</b>    |
| PC-110P   | BASKET STAND FOR 11" PRIMERO ADJ. HEIGHT ..... | <b>75.00</b>    |

### BONGO STANDS

|           |   |                 |
|-----------|---|-----------------|
| PB-900LW  | LIGHTWEIGHT FITS VIRTUALLY ALL BONGOS .....     | <b>\$200.00</b> |
| PB-700    | SGL. BR. LEGS NEW FIT-ALL CLAMPING SYSTEM ..... | <b>129.00</b>   |
| PB-700BHS | BONGO ATTACHMENT FOR PC-200W .....              | <b>75.00</b>    |
| PB-900BH  | BONGO UPPER TUBE w/STRAP FOR RACKS, ETC. ....   | <b>110.00</b>   |

### TRAVEL CONGA STANDS

|           |  |                 |
|-----------|--|-----------------|
| PC-1100TC | TRAVEL CONGA STAND w/BAG FOR 11" .....           | <b>\$275.00</b> |
| PC-1175TC | TRAVEL CONGA STAND w/BAG FOR 11.75" .....        | <b>275.00</b>   |
| PC-1250TC | TRAVEL CONGA STAND w/BAG FOR 12.5" .....         | <b>275.00</b>   |
| PPS-50TC  | STAND BRIDGE CONNECTS STANDS FOR STABILITY ..... | <b>49.00</b>    |

### DJEMBE STANDS

|         |   |                 |
|---------|---|-----------------|
| PC-800S | SINGLE-BRACED DJEMBE STAND FITS ALL DJEMBES ..... | <b>\$189.00</b> |
|---------|---|-----------------|

### TIMBALE STAND w/DBL BR. LEGS

|         |  |                 |
|---------|--|-----------------|
| PT-900W | TILTING STAND w/NO VIBRATION COWBELL MOUNT ..... | <b>\$199.00</b> |
|---------|--|-----------------|

### CAJON STAND

|           |  |                 |
|-----------|--|-----------------|
| PCJ-70STD | TILTING STAND w/ADJUSTABLE ARMS - VERY VERSATILE ..... | <b>\$239.00</b> |
|-----------|--|-----------------|

## HOLDERS & ACCESSORIES

### HOLDERS

|          |  |                |
|----------|--|----------------|
| PCS-10   | COWBELL STACKER .....                                | <b>\$35.00</b> |
| PGB-10   | GOCK BLOCK HOLDER .....                              | <b>29.00</b>   |
| PJBS-350 | DJEM-BASS CONVERTS 14" DJEMBE TO BASS DRUM .....     | <b>140.00</b>  |
| PPS-10   | STIX-FREE (SMALL) PLAY COWBELLS WITHOUT STICKS ..... | <b>45.00</b>   |
| PPS-11   | STIX-FREE (LARGE) PLAY COWBELLS WITHOUT STICKS ..... | <b>45.00</b>   |
| PPS-35   | ANGLED SINGLE POST HOLDER .....                      | <b>30.00</b>   |
| PPS-37   | ADJUSTABLE HOLDER w/QUICK RELEASE ADAPTER .....      | <b>49.00</b>   |
| PPS-40   | LUG MOUNT HOLDER .....                               | <b>55.00</b>   |
| PPS-81   | RACK 12" 4 STRAIGHT POSTS & 2 "Z" POSTS .....        | <b>79.00</b>   |
| PPS-82   | RACK 18" 4 STRAIGHT POSTS & 2 "Z" POSTS .....        | <b>99.00</b>   |
| PPS-20   | FOOT PEDAL BRACKET .....                             | <b>85.00</b>   |
| PPS-20L  | FOOT PEDAL BRACKET w/LONG "L" ROD .....              | <b>87.00</b>   |

### BOX CAJON ACCESSORIES

|          |   |                |
|----------|---|----------------|
| PBCW-100 | WOOD BLOCK w/DUAL-LOCK TAPE & MTG BRK .....       | <b>\$62.00</b> |
| PBCC-100 | CLAVE BLOCK w/DUAL-LOCK TAPE & MTG BRK .....      | <b>54.00</b>   |
| PSC-BC   | SEAT CUSHION w/THICK FOAM FOR COMFORT .....       | <b>35.00</b>   |
| PJCP-1   | JINGLE CUPS 1 SET OF BRASS & STEEL JINGLES .....  | <b>24.00</b>   |
| PJCP-1/6 | JINGLE CUPS 6 SETS OF BRASS & STEEL JINGLES ..... | <b>160.00</b>  |
| PCB-DL   | DUAL-LOCK TAPE FOR PBCW-100 & PBCC-100 .....      | <b>9.00</b>    |
| CAJH-100 | CAJON HOLSTER .....                               | <b>45.00</b>   |

### CONGA ACCESSORIES

|         |   |                |
|---------|---|----------------|
| PRP-140 | CONGA RESOPLATE MAXIMIZES RESONANCE ..... | <b>\$54.00</b> |
|---------|---|----------------|

## TRAP TABLES

|             |   |          |
|-------------|---|----------|
| PTYB-1212   | TOY BOX CARRYING CASE/TRAP TABLE .....  | \$175.00 |
| PTT-1212    | 12"X12" TRAP TABLE .....  | 85.00    |
| PTT-1824    | 18"X24" TRAP TABLE w/SGL BRACED STAND .....                                   | 240.00   |
| PTT-1824W   | 18"X24" TRAP TABLE w/DBL BRACED STAND .....                                   | 275.00   |
| PTT-1523MP  | MALLET/STICK/TRAP TRAY w/CLAMP 12"x23" .....                                  | 229.00   |
| PTT-1215MP  | MALLET/STICK/TRAP TRAY w/CLAMP 12"x15" .....                                  | 219.00   |
| PTR-1824    | PERC. RACK ADD-ON FOR PTT-1824 .....  | 285.00   |
| PTR-1824RC1 | ROD & CLAMP ADD-ON FOR PTR-1824 STRAIGHT .....                                | 20.00    |
| PTR-1824RC2 | ROD & CLAMP ADD-ON FOR PTR-1824 ANGLED .....                                  | 25.00    |
| PTR-1824RC3 | SINGLE POST ADAPTER FOR PTT-1824/PTT-1212 .....                               | 35.00    |
| PTR-UNV     | "UNIVERSAL-FIT" TRAP TABLE RACK FITS MANY BRANDS & SIZES OF TRAP TABLES ..... | 200.00   |

## ANARCHY SERIES

|         |  |         |
|---------|--|---------|
| PCB-20  | HEAVY METAL COWBELL "BRUTAL, CUTTING TONE" ..... | \$46.00 |
| PAR-100 | HEAVY METAL CRASHER "WHITE NOISE BLAST" .....    | 87.00   |
| PBL-100 | HEAVY METAL BLOCK "SKULL CRUSHING SHOT" .....    | 50.00   |

## COWBELLS

|  |  |         |
|--|--|---------|
| <b>HORACIO HERNANDEZ SIGNATURE COWBELLS II</b> |  |         |
| HH-1X  | BELLA (HIGH-PITCH CHA CHA) w/QUICK RELEASE BRACKET ..... | \$59.00 |
| HH-2X  | CLABELL (FOOT CLAVE BELL) w/QUICK RELEASE BRACKET .....  | 67.00   |
| HH-3X  | CHABELLA (LOW-PITCH CHA CHA) w/QUICK RELEASE BRACKET ..  | 70.00   |
| HH-4X  | ISABELL (MAMBO BELL) w/QUICK RELEASE BRACKET .....       | 75.00   |
| HH-5X  | MARYBELL (TIMBALE BELL) w/QUICK RELEASE BRACKET .....    | 82.00   |

### BALA BELLS

|        |  |         |
|--------|--|---------|
| BCM-10 | MOUNTED CAMPANA BELL .....               | \$82.00 |
| BCH-10 | HAND-HELD CAMPANA BELL LOW-PITCHED ..... | 68.00   |

### NEW YORKER BELLS - ONE PIECE CONSTRUCTION

|          |   |         |
|----------|---|---------|
| BCM-3NY  | CHA CHA HI-PITCHED .....                  | \$65.00 |
| BCM-5NY  | CHA CHA LOW-PITCHED .....                 | 65.00   |
| BCM-7NY  | MAMBO .....                               | 76.00   |
| BCM-8NYQ | TIMBAL MARC QUINONES SIGNATURE BELL ..... | 84.00   |

### TRI-BELLS

|        |   |         |
|--------|---|---------|
| PTA-30 | TRI-AGOGO PLAYED HAND-HELD OR MOUNTED ..... | \$98.00 |
| PTB-30 | TRI-BELLS PLAYED HAND-HELD OR MOUNTED ..... | 89.00   |

### AGOGO BELLS

|        |                       |         |
|--------|-----------------------|---------|
| ECB-22 | HAND-HELD AGOGO ..... | \$43.00 |
| ECB-23 | MOUNTED AGOGO .....   | 51.00   |

### PRIMERO COWBELLS

|                     |  |         |
|---------------------|--|---------|
| PCB-4               | 4" BELL .....                                  | \$21.00 |
| PCB-6               | 6" BELL .....                                  | 25.00   |
| PCB10               | PRIMERO ROCK COWBELL .....                     | 32.00   |
| <i>NEW</i> PCB10MCR | PRIMERO ROCK BELL S.E. MILLENNIUM CHROME ..... | 40.00   |
| PCB-1030            | ROCK BELL w/PPS-30 MOUNT .....                 | 50.00   |

### COWBELL BEATERS

|        |   |         |
|--------|---|---------|
| PDC-10 | DUAL COWBELL BEATER w/RUBBER & WOOD SIDES ..... | \$15.00 |
| PDC-60 | PRO COWBELL BEATER .....                        | 19.00   |

## BRAZILIAN PERCUSSION

|           |                                       |          |
|-----------|---------------------------------------|----------|
| PBCX-1204 | 12"x4" CAIXA (SNARE DRUM) .....       | \$185.00 |
| PBCX-1265 | 12"x6.5" CAIXA (SNARE DRUM) .....     | 205.00   |
| PBS-2222  | 22"x22" SURDO .....                   | 605.00   |
| PBS-2018  | 20"x18" SURDO .....                   | 570.00   |
| PBS-1822  | 18"x22" SURDO .....                   | 550.00   |
| PBSM-20   | SURDO MALLET .....                    | 24.00    |
| PBS-30BD  | LEGS & BD ADAPTOR KIT FOR SURDO ..... | 130.00   |
| PBS-22H   | 22" REPLACEMENT SURDO HEAD .....      | 150.00   |
| PBS-20H   | 20" REPLACEMENT SURDO HEAD .....      | 130.00   |
| PBS-18H   | 18" REPLACEMENT SURDO HEAD .....      | 120.00   |
| PBR-10S   | 10" STEEL REPINIQUE w/STRAP .....     | 250.00   |
| PBR-12S   | 12" STEEL REPINIQUE w/STRAP .....     | 295.00   |

|           |   |          |
|-----------|---|----------|
| PBC-80SS  | STEEL CUICA .....                                 | \$220.00 |
| PBC-80S   | CUICA STICK .....                                 | 6.60     |
| PBC-80H   | 8" CUICA GOATSKIN HEAD .....                      | 60.00    |
| PBT-60C   | TAMBORIM w/QUICK DRAW MOUNT .....                 | 85.00    |
| PBT-70S   | TAMBORIM STICK w/AUTHENTIC 7-BRISTLE DESIGN ..... | 25.00    |
| PBP-510   | 10" PANDEIRO w/BAG (GOATSKIN HEAD) .....          | 150.00   |
| PBP-612   | 12" PANDEIRO w/BAG (PLASTIC HEAD) .....           | 150.00   |
| PDZ-510   | PANDANZA w/AGOGO BELL .....                       | 160.00   |
| PBRC-80   | ROCAR .....                                       | 130.00   |
| PBTB-140  | TIMBAO w/STRAP (BRAZILIAN CONGA DRUM) .....       | 470.00   |
| PBTA-1420 | 14" TAN TAN (HAND SURDO) .....                    | 305.00   |

## FIELD PERCUSSION

### TAIKO

|                     |   |            |
|---------------------|---|------------|
| <i>NEW</i> WST-20FP | SHIME TAIKO w/TENSION RODS REMO HEADS ..... | \$1,359.00 |
|---------------------|---|------------|

### DJEMBE

|                          |   |          |
|--------------------------|---|----------|
| <i>NEW</i> PJF-350FP649* | 14" DJEMBE FIBERGLASS w/NUSKYN REMO HEADS ..... | \$640.00 |
|--------------------------|---|----------|

\*#649 TEXTURED BLACK FINISH FOR OUTDOORS

### SHAKER

|                      |  |         |
|----------------------|--|---------|
| <i>NEW</i> PGA-60FP* | FIELD PERCUSSION SHAKER 21" w/CHAMBERED CENTER ... | \$85.00 |
|----------------------|--|---------|

### CONGA - SET

|                           |   |          |
|---------------------------|---|----------|
| <i>NEW</i> PFC-202EDU649* | 10"/11" FIBERGLASS CONGA SET w/PC-300 STAND ..... | \$640.00 |
|---------------------------|---|----------|

## BANDA PERCUSSION

### TAMBORA

|                          |  |          |
|--------------------------|--|----------|
| <i>NEW</i> PBTB-2418/C33 | BANDA TAMBORA w/STAND CYM HOLDER & BEATER #33 PURE WHITE ..... | \$799.00 |
|--------------------------|--|----------|

### TIMBALES

|                       |   |          |
|-----------------------|---|----------|
| <i>NEW</i> PBTM-1516C | 15X10"/16X10" STEEL w/TILTING STAND ..... | \$385.00 |
|-----------------------|---|----------|

## BAGS

|            |  |          |
|------------|--|----------|
| PTYB-1212  | TOY BOX CARRYING CASE/TRAP TABLE .....                     | \$175.00 |
| PSC-110CG  | CONGA BAG FOR 11" .....                                    | 175.00   |
| PSC-117CG  | CONGA BAG FOR 11.75" .....                                 | 175.00   |
| PSC-125CG  | CONGA BAG FOR 12.5" .....                                  | 175.00   |
| PPB-100    | FIT ALL CONGA BAG .....                                    | 83.00    |
| PSC-1175TC | TRAVEL CONGA BAG - FITS ALL 3 SIZES OF TRAVEL CONGAS ..... | 90.00    |
| PSC-BB     | BONGO BAG .....  | 110.00   |
| PSC-125DJ  | DJEMBE BAG FOR 12.5" .....                                 | 140.00   |
| PSC-140DJ  | DJEMBE BAG FOR 14" .....                                   | 140.00   |

|            |   |         |
|------------|---|---------|
| PSC-1213CJ | BOX CAJON BAG - FITS ALL PEARL BOX CAJONS ..... | \$98.00 |
| PSC-2222BS | SURDO BAG FOR 22"x22" .....                     | 305.00  |
| PSC-1822BS | SURDO BAG FOR 18"x22" .....                     | 275.00  |

# HAND PERCUSSION

## AGO-SHA AGOGO+SHAKER

|         |  |         |
|---------|--|---------|
| PAS-50  | AGO-SHA w/SINGLE AGOGO BELL .....      | \$45.00 |
| PAS-100 | AGO-SHA w/HIGH & LOW AGOGO BELLS ..... | 65.00   |

## BLOCKS

|           |   |         |
|-----------|---|---------|
| PBL-10    | HIGH CLAVE BLOCK w/HOLDER (NEON GREEN) .....        | \$55.00 |
| PBL-20    | MEDIUM CLAVE BLOCK w/HOLDER (NEON YELLOW) .....     | 55.00   |
| PBL-30    | LOW CLAVE BLOCK w/HOLDER (NEON ORANGE) .....        | 55.00   |
| PAB-20    | ASH TONE BLOCK HI-PITCH .....                       | 36.00   |
| PAB-50    | ASH TONE BLOCK MED-PITCH .....                      | 43.00   |
| PAB-100   | ASH TONE BLOCK LOW-PITCH .....                      | 50.00   |
| PCWB-100A | ELITE CONCERT WOOD BLOCKS w/MOUNT (2x2x6") .....    | 54.00   |
| PCWB-200A | ELITE CONCERT WOOD BLOCKS w/MOUNT (3x3x9") .....    | 62.00   |
| PCWB-300A | ELITE CONCERT WOOD BLOCKS w/MOUNT (4x4.5x10") ..... | 73.00   |
| PCWTB-05  | TEMPLE BLOCK SET (SET OF 5) .....                   | 449.00  |

## CABASA

ONE-HANDED OPERATION

|         |                                 |          |
|---------|---------------------------------|----------|
| CBS-100 | "GATLING" CABASA w/HOLDER ..... | \$140.00 |
|---------|---------------------------------|----------|

## CASTANETS - CHIN CHAN WOOD

|         |                                       |         |
|---------|---------------------------------------|---------|
| PCN-20S | CASTANETS w/BAG - SHORT HANDLES ..... | \$93.00 |
| PCN-20H | CASTANETS HOLDER .....                | 54.00   |

## CLAVES

|           |   |         |
|-----------|---|---------|
| PCL-10    | FIBER CLAVES - VERY CUTTING SOUND ..... | \$40.00 |
| PCL-10FCB | TRADITIONAL CLAVES - BAMBOO .....       | 24.00   |
| PCL-20FCW | FOLKLORE CLAVES - WOOD .....            | 29.00   |

## FOLKLORE TRADITIONAL PERCUSSION

|          |  |         |
|----------|--|---------|
| PCA-14FC | TRADITIONAL CATA' w/HOLDER 13" - 16" BAMBOO .....      | \$61.00 |
| PAC-10FC | TRADITIONAL ACHERE w/HANDLE - LOUD SINGLE SHAKER ..... | 36.00   |
| PGT-10FC | TRADITIONAL GUATACA PLAYED HANDHELD OR MOUNTED .....   | 73.00   |

## GUIROS / GUIRO HOLDER

|        |   |         |
|--------|---|---------|
| PFG-20 | FIBER GUIRO w/GOURD & METAL SURFACES w/STICKS ..... | \$95.00 |
| PMG-20 | METAL GUIRO PERFECT FOR MERENGUE RHYTHMS .....      | 85.00   |
| PNG-20 | NATURAL GOURD GUIRO .....                           | 105.00  |
| PGH-20 | UNIVERSAL GUIRO HOLDER INCLUDES 3/8" Z-ROD .....    | 65.00   |

## JINGLE RING

|          |  |         |
|----------|--|---------|
| PJH-10SH | HI-HAT JINGLE RING w/20 PAIRS OF STAINLESS STEEL JINGLES ..... | \$75.00 |
|----------|--|---------|

## LOG DRUM

MAHOGANY TOP ACACIA WOOD BODY 2 PITCHES PER DRUM

|                     |   |          |
|---------------------|---|----------|
| <i>NEW</i> PCW-LD25 | 25"x6"x6" CONCERT LOG DRUM w/ AIR SUS RUBBER FEET ..... | \$499.00 |
| <i>NEW</i> PCW-LD30 | 30"x6"x6" CONCERT LOG DRUM w/ AIR SUS RUBBER FEET ..... | \$65.00  |

## MARACAS

|        |  |         |
|--------|--|---------|
| PFM-20 | BEADED MARACAS w/SHEKERE-TYPE BEADS .....  | \$40.00 |
| PRM-20 | NATURAL HIDE MARACAS .....                 | 109.00  |
| PFM-50 | "MARACABASA" MARACAS & CABASA IN ONE ..... | 60.00   |

## RATTLER

|         |                     |         |
|---------|---------------------|---------|
| PRT-10  | RATTLER .....       | \$73.00 |
| PRT-10C | RATTLER CLAMP ..... | 80.00   |

## SHEKERE

|         |  |          |
|---------|--|----------|
| PSK-10  | FIBERGLASS SHEKERE .....                             | \$199.00 |
| PSK50FC | TRADITIONAL NATURAL GOURD SHEKERE - UNO (SM) .....   | 165.00   |
| PSK60FC | TRADITIONAL NATURAL GOURD SHEKERE - SEGUNDO (MED) .. | 185.00   |
| PSK70FC | TRADITIONAL NATURAL GOURD SHEKERE - CAJA (LG) .....  | 220.00   |

## SHEKERE

|         |  |          |
|---------|--|----------|
| PSK-10  | FIBERGLASS SHEKERE .....                             | \$199.00 |
| PSK50FC | TRADITIONAL NATURAL GOURD SHEKERE - UNO (SM) .....   | 165.00   |
| PSK60FC | TRADITIONAL NATURAL GOURD SHEKERE - SEGUNDO (MED) .. | 185.00   |
| PSK70FC | TRADITIONAL NATURAL GOURD SHEKERE - CAJA (LG) .....  | 220.00   |

## SHAKERINE SHAKER + TAMBOURINE

|        |  |         |
|--------|--|---------|
| PSR-03 | SHAKERINE .....                                | \$99.00 |
| PSR-01 | MINI-SHAKERINE w/TAMBOURINE JINGLES .....      | 35.00   |
| PGR-03 | GANZEIRO - COMBINATION PANDEIRO & SHAKER ..... | 70.00   |
| PGR-01 | MINI-GANZEIRO w/PANDEIRO JINGLES .....         | 40.00   |

## SHAKERS

|          |  |         |
|----------|--|---------|
| PGA-20   | BASKET GANZA 9"x4" .....                           | \$25.00 |
| PGA-30   | HEX GANZA (SHORT) PRODUCES FOUR PITCHES .....      | 30.00   |
| PGA-32   | HEX GANZA (LONG) PRODUCES FOUR PITCHES .....       | 30.00   |
| PGA-40   | TRIPLE-SHAKER "SHAKE - CLICK - SWISH" SOUNDS ..... | 55.00   |
| PGA-50SF | GROOVE-SHAKER ATTACHES TO DRUM STICKS .....        | 40.00   |
| PEC-1    | EGG CARTON SINGLE TUBE w/3 EGGS .....              | 25.00   |
| PEC-1/6  | EGG CARTON SIX PEC-1 TUBES .....                   | 150.00  |
| PWR-40   | "SHAKELETS" - BRACELET w/SHAKERS (1 PR) .....      | 55.00   |

## SLAP STICK

|         |                  |         |
|---------|------------------|---------|
| PSS-100 | SLAP STICK ..... | \$55.00 |
|---------|------------------|---------|

## SPIRIT CHIMES

CAN BE MOUNTED OR HAND-HELD - MOUNT INCLUDED

|        |   |         |
|--------|---|---------|
| PSC-30 | SPIRIT CHIMES w/3 TONES, INCLUDES HOLDER & Mallet ..... | \$55.00 |
|--------|---|---------|

## TAMBOURINES / TOMBOURINES

|                     |   |          |
|---------------------|---|----------|
| PETM-1017           | SYMP. TAMBOURINE w/BAG w/17 PR. STAMPED BRASS JINGLES ..... | \$150.00 |
| PTM-10GH            | TAMBOURINE w/QUICKMOUNT - BRASS JINGLES .....               | 75.00    |
| PTM-10SH            | TAMBOURINE w/QUICKMOUNT - STAINLESS STEEL JINGLES .....     | 55.00    |
| PTH-10S             | 10" HEADLESS TAMBOURINE - STAINLESS STEEL JINGLES .....     | 55.00    |
| PTH-10B             | 10" HEADLESS TAMBOURINE w/BRASS JINGLES .....               | 85.00    |
| PETM-20             | ELITE CONCERT TAMBOURINE w/CASE (DOUBLE ROW) .....          | 120.00   |
| PTB-10              | 10" TOMBOURINE w/QUICKMOUNT .....                           | 120.00   |
| PTM-50SHR           | ULTRA-GRIP w/ADJUSTABLE VOLUME & STEEL JINGLES .....        | 70.00    |
| PTM-50BHR           | ULTRA-GRIP w/ADJUSTABLE VOLUME & BRASS JINGLES .....        | 85.00    |
| <i>NEW</i> PTM-09BK | 9" OVAL TAMBOURINE w/MILLENNIUM CHROME JINGLES .....        | 65.00    |

## TRIANGLES & TRIANGLE HOLDERS

|         |  |         |
|---------|--|---------|
| PET60   | 6" ELITE CONCERT TRIANGLE w/BEATER & CASE .....        | \$65.00 |
| PET80   | 8" ELITE CONCERT TRIANGLE w/BEATER & CASE .....        | 75.00   |
| PET100  | 10" ELITE CONCERT TRIANGLE w/BEATER & CASE .....       | 85.00   |
| PETB-30 | ELITE CONCERT TRIANGLE BEATERS w/CASE - SET OF 3 ..... | 35.00   |
| PTC-10  | TRIANGLE CLIP .....                                    | 20.00   |
| PTC-300 | TRIO TRIANGLE HOLDER .....                             | 110.00  |
| PPS-12T | STIX-FREE TRIANGLE HOLDER w/8" TRIANGLE .....          | 120.00  |

## TANG-TANG

SHAKER w/CAXIXI STYLE PLATE & WOODEN "CLACKER"

|        |                                |         |
|--------|--------------------------------|---------|
| PTG-20 | TANG-TANG HIGH & LOW SET ..... | \$68.00 |
|--------|--------------------------------|---------|

## WINDCHIMES

STACKABLE TO CREATE MULTIPLE ROW WINDCHIMES

|            |   |          |
|------------|---|----------|
| PWCH-3220A | 32 BAR ALUMINUM w/HOLDER, STRIKER & CASE .....            | \$239.00 |
| PWCH-3220G | 32 BAR GOLD ANODIZED ALUM. w/HOLDER, STRIKER & CASE ..... | 249.00   |
| PWCH-3620A | 36 BAR ALUMINUM CHROMATIC w/HOLDER, STRIKER & CASE .....  | 275.00   |
| PWC-32A    | 32 BAR ALUMINUM w/STRIKER .....                           | 179.00   |

# REPLACEMENT HEADS & PARTS

|           |   |         |
|-----------|---|---------|
| PH100WDX  | 10" ELITE WOOD RE-QUINTO REPLACEMENT HEAD .....   | \$65.00 |
| PH110WDX  | 11" ELITE WOOD QUINTO REPLACEMENT HEAD .....      | 69.00   |
| PH117WDX  | 11.75" ELITE WOOD CONGA REPLACEMENT HEAD .....    | 75.00   |
| PH125WDX  | 12.5" ELITE WOOD TUMBA REPLACEMENT HEAD .....     | 79.00   |
| PH140WDX  | 14" ELITE WOOD SUPER TUMBA REPLACEMENT HEAD ..... | 85.00   |
| PH70WDX   | 7" ELITE WOOD BONGO REPLACEMENT HEAD .....        | 48.00   |
| PH90WDX   | 9" ELITE WOOD BONGO REPLACEMENT HEAD .....        | 54.00   |
| PH340W    | 12.5" ELITE WOOD DJEMBE REPLACEMENT HEAD .....    | 89.00   |
| PH125RD   | 12.5" EZ TUNE WOOD DJEMBE REPLACEMENT HEAD .....  | 105.00  |
| PH140RD   | 14" EZ TUNE WOOD DJEMBE REPLACEMENT HEAD .....    | 130.00  |
| PH110F    | 11" ELITE FIBER QUINTO REPLACEMENT HEAD .....     | 69.00   |
| PH117F    | 11.75" ELITE FIBER CONGA REPLACEMENT HEAD .....   | 75.00   |
| PH125F    | 12.5" ELITE FIBER TUMBA REPLACEMENT HEAD .....    | 79.00   |
| PH70F     | 7" ELITE FIBER BONGO REPLACEMENT HEAD .....       | 48.00   |
| PH90F     | 9" ELITE FIBER BONGO REPLACEMENT HEAD .....       | 54.00   |
| PH320F    | 12.5" ELITE FIBER DJEMBE REPLACEMENT HEAD .....   | 89.00   |
| PH350F    | 14" ELITE FIBER DJEMBE REPLACEMENT HEAD .....     | 99.00   |
| PH320RX   | 12" EZ TUNE FIBER DJEMBE REPLACEMENT HEAD .....   | 120.00  |
| PH350RX   | 14" EZ TUNE FIBER DJEMBE REPLACEMENT HEAD .....   | 150.00  |
| PH110WFCE | 11" ELITE HEAD FOR FOLKLORE QUINTO .....          | 119.00  |
| PH117WFCE | 11.75" ELITE HEAD FOR FOLKLORE CONGA .....        | 129.00  |
| PH125WFCE | 12.5" ELITE HEAD FOR FOLKLORE TUMBA .....         | 135.00  |
| PH70WFCE  | 7" ELITE HEAD FOR FOLKLORE BONGO .....            | 79.00   |
| PH850WFCE | 8.5" ELITE HEAD FOR FOLKLORE BONGO .....          | 89.00   |

|                      |  |          |
|----------------------|--|----------|
| PH110WFC             | 11" FOLKLORE QUINTO REPLACEMENT HEAD .....                                       | \$119.00 |
| PH117WFC             | 11.75" FOLKLORE CONGA REPLACEMENT HEAD .....                                     | 129.00   |
| PH125WFC             | 12.5" FOLKLORE TUMBA REPLACEMENT HEAD .....                                      | 135.00   |
| PH70WFC              | 7" FOLKLORE BONGO REPLACEMENT HEAD .....   | 79.00    |
| PH850WFC             | 8.5" FOLKLORE BONGO REPLACEMENT HEAD .....                                       | 89.00    |
| M41106TCPL           | 11" FIBERSKYN HEAD - TRAVEL/ALLENDE/FLORES CONGAS (w/TRAVEL CONGA LOGO) .....    | 87.60    |
| M41175TCPL           | 11.75" FIBERSKYN HEAD - TRAVEL/ALLENDE/FLORES CONGAS (w/TRAVEL CONGA LOGO) ..... | 91.70    |
| M41250TCPL           | 12.5" FIBERSKYN HEAD - TRAVEL/ALLENDE/FLORES CONGAS (w/TRAVEL CONGA LOGO) .....  | 97.60    |
| PH100PW              | 10" PRIMERO WOOD QUINTO REPLACEMENT HEAD .....                                   | 49.00    |
| PH110PW              | 11" PRIMERO WOOD CONGA REPLACEMENT HEAD .....                                    | 53.00    |
| PH60PW               | 6" PRIMERO WOOD BONGO REPLACEMENT HEAD .....                                     | 30.00    |
| PH70PW               | 7" PRIMERO WOOD BONGO REPLACEMENT HEAD .....                                     | 31.00    |
| PH850PW              | 8.5" PRIMERO WOOD BONGO REPLACEMENT HEAD .....                                   | 35.00    |
| PH100PF              | 10" PRIMERO FIBER QUINTO REPLACEMENT HEAD .....                                  | 49.00    |
| PH110PF              | 11" PRIMERO FIBER CONGA REPLACEMENT HEAD .....                                   | 53.00    |
| PH60PF               | 6" PRIMERO FIBER BONGO REPLACEMENT HEAD .....                                    | 30.00    |
| PH70PF               | 7" PRIMERO FIBER BONGO REPLACEMENT HEAD .....                                    | 48.00    |
| PH310F               | 9.5" FIBER MINI-DJEMBE REPLACEMENT HEAD .....                                    | 54.00    |
| PL110DX              | ELITE CONGA LUG .....  | 10.00    |
| PL70DX               | ELITE BONGO LUG .....  | 10.00    |
| PCH01WC              | CARRYING HANDLE FOR ELITE MODEL CONGAS .....                                     | 20.00    |
| PSMB01W              | STAND MOUNTING BRACKET FOR ELITE CONGAS .....                                    | 11.00    |
| PL100P               | PRIMERO CONGA LUG .....  | 9.00     |
| PL70P                | PRIMERO BONGO LUG .....  | 9.00     |
| <i>NEW</i> TK-1410N2 | SHIME TAIKO HEAD .....   | 353.00   |

# MARCHING CARRIERS & STANDS

## PEARL CX AIR FRAME CARRIERS

|                     |   |                 |
|---------------------|---|-----------------|
| <b>CXS-1</b>        | SNARE CARRIER - SUPERLIGHT FOR COMFORT, ACS WAIST BELT - INCLUDES CXSA-2 SNARE ATTACHMENT .....         | <b>\$440.00</b> |
| <b>CXT-1</b>        | TENOR CARRIER - SUPERLIGHT FOR COMFORT, ACS WAIST BELT - INCLUDES CXBB-1/B BACKBAR .....                | <b>490.50</b>   |
| <b>CXB-1</b>        | BASS CARRIER - SUPERLIGHT FOR COMFORT, ACS WAIST BELT FOR AGILITY, CONTROL AND SUPPORT .....            | <b>440.00</b>   |
| <b>NEW CXSA-2</b>   | SNARE ATTACHMENT 12% LIGHTER W/ 30+ DEGREES OF DOWN ANGLE ADJ FOR CXS-1 AND MXSP-1 SNARE CARRIERS ..... | <b>86.00</b>    |
| <b>NEW CXBB-1/B</b> | BACKBAR (ONLY) w/BLACK FINISH FOR CXT-1 TENOR CARRIER.....  | <b>178.00</b>   |
| <b>NEW BBS-68/B</b> | 6" & 8" TOM MOUNTING ATTACHMENT SET w/BLACK FINISH.....   | <b>31.00</b>    |
| <b>NEW BBS-6S</b>   | 6" TOM MOUNTING ATTACHMENT w/BOLTS & NUTS w/BLACK FINISH.....   | <b>23.50</b>    |
| <b>NEW BBS-8/B</b>  | 8" TOM MOUNTING ATTACHMENT w/BOLTS & NUTS w/BLACK FINISH.....   | <b>11.00</b>    |
| <b>AL-84A</b>       | SHOULDER BACKPLATE ASSEMBLY COMPLETE .....  | <b>24.00</b>    |
| <b>NP-479NL</b>     | SHOULDER CUSHION (LEFT) FOR CX CARRIERS .....   | <b>37.00</b>    |
| <b>NP-479NR</b>     | SHOULDER CUSHION (RIGHT) FOR CX CARRIERS .....  | <b>37.00</b>    |
| <b>NP-478N</b>      | BELLY PLATE CUSHION (ONLY) FOR CX CARRIERS .....  | <b>29.50</b>    |
| <b>NP-492A</b>      | ACS BELT W/CUSHION FOR CX CARRIERS .....  | <b>36.00</b>    |

## PEARL PIPE DRUM CARRIERS

|               |   |                 |
|---------------|---|-----------------|
| <b>CXSP-1</b> | CX PIPE SNARE CARRIER, INCLUDES CXSA-2 SNARE ATTACHMENT .....   | <b>\$474.00</b> |
| <b>MXSP-1</b> | MX PIPE SNARE T-CARRIER, INCLUDES CXSA-2 SNARE ATTACHMENT ..... | <b>321.50</b>   |

## PEARL MX T-FRAME CARRIERS

|                      |   |                 |
|----------------------|---|-----------------|
| <b>MXS-1</b>         | SNARE T-CARRIER, INCLUDES MXSA-1/B SNARE ATTACHMENT .....       | <b>\$271.00</b> |
| <b>MXT-1</b>         | QUAD T-CARRIER, INCLUDES MX4BB-1/B BACKBAR .....                | <b>333.00</b>   |
| <b>MXT3-1</b>        | TRIO T-CARRIER, INCLUDES MX3BB-1/B BACKBAR .....                | <b>304.50</b>   |
| <b>MXB-1</b>         | BASS T-CARRIER .....  | <b>231.50</b>   |
| <b>NEW MXSA-1/B</b>  | SNARE ATTACHMENT w/BLACK FINISH FOR MXS-1 SNARE CARRIER .....   | <b>76.00</b>    |
| <b>NEW MX3BB-1/B</b> | BACKBAR (ONLY) w/BLACK FINISH FOR MXT3-1 TRIO TOM CARRIER ..... | <b>79.00</b>    |
| <b>NEW MX4BB-1/B</b> | BACKBAR (ONLY) w/BLACK FINISH FOR MXT-1 QUAD TOM CARRIER .....  | <b>93.00</b>    |

## PEARL MARCHING STANDS

|                 |  |                 |
|-----------------|--|-----------------|
| <b>MSS-3000</b> | MARCHING SNARE STAND - ADJUSTABLE LEGS FOR BLEACHERS OR LEVEL SURFACES ..... | <b>\$282.00</b> |
| <b>MTS-3000</b> | MARCHING TOM STAND - ADJUSTABLE LEGS FOR BLEACHERS OR LEVEL SURFACES .....   | <b>316.00</b>   |
| <b>MBS-3000</b> | MARCHING BASS STAND - ADJUSTABLE LEGS FOR BLEACHERS OR LEVEL SURFACES .....  | <b>310.50</b>   |

# MARCHING CASES, COVERS & REPLACEMENT STRAPS

### CASES - ROTATIONALLY MOLDED

|                |                           |                 |
|----------------|---------------------------|-----------------|
| <b>PD-1412</b> | 13"/14" SNARE DRUMS ..... | <b>\$147.50</b> |
| <b>PD-8004</b> | QUAD/QUINT/SEXTET .....   | <b>283.50</b>   |
| <b>PD-1414</b> | 14"x14" BASS DRUM .....   | <b>147.50</b>   |
| <b>PD-1614</b> | 16"x14" BASS DRUM .....   | <b>159.00</b>   |
| <b>PD-1814</b> | 18"x14" BASS DRUM .....   | <b>164.50</b>   |
| <b>PD-2014</b> | 20"x14" BASS DRUM .....   | <b>181.50</b>   |
| <b>PD-2214</b> | 22"x14" BASS DRUM .....   | <b>204.50</b>   |
| <b>PD-2414</b> | 24"x14" BASS DRUM .....   | <b>221.50</b>   |
| <b>PD-2614</b> | 26"x14" BASS DRUM .....   | <b>238.50</b>   |
| <b>PD-2814</b> | 28"x14" BASS DRUM .....   | <b>250.00</b>   |
| <b>PD-3016</b> | 30"x16" BASS DRUM .....   | <b>255.50</b>   |
| <b>PD-3216</b> | 32"x16" BASS DRUM .....   | <b>261.00</b>   |

\* LIMITED LIFETIME WARRANTY \* NO FOAM

### COVERS - GREY

|                  |                             |                |
|------------------|-----------------------------|----------------|
| <b>MDCG-13</b>   | 13" SNARE .....             | <b>\$63.50</b> |
| <b>MDCG-14</b>   | 14" SNARE .....             | <b>63.50</b>   |
| <b>MDCG-8023</b> | QUAD FITS 8023 & 8024 ..... | <b>88.00</b>   |
| <b>MDCG-0234</b> | QUAD FITS 0234 .....        | <b>88.00</b>   |
| <b>MDCG-14B</b>  | 14" BASS DRUM .....         | <b>63.50</b>   |
| <b>MDCG-16</b>   | 16" BASS DRUM .....         | <b>69.00</b>   |
| <b>MDCG-18</b>   | 18" BASS DRUM .....         | <b>69.00</b>   |
| <b>MDCG-20</b>   | 20" BASS DRUM .....         | <b>77.00</b>   |
| <b>MDCG-22</b>   | 22" BASS DRUM .....         | <b>77.00</b>   |
| <b>MDCG-24</b>   | 24" BASS DRUM .....         | <b>82.50</b>   |
| <b>MDCG-26</b>   | 26" BASS DRUM .....         | <b>88.00</b>   |
| <b>MDCG-28</b>   | 28" BASS DRUM .....         | <b>88.00</b>   |
| <b>MDCG-30</b>   | 30" BASS DRUM .....         | <b>93.50</b>   |
| <b>MDCG-32</b>   | 32" BASS DRUM .....         | <b>93.50</b>   |

### STRAPS

|                |  |                |
|----------------|--|----------------|
| <b>PDS-60</b>  | 60" w/CLIP FOR PDCH .....              | <b>\$15.50</b> |
| <b>PDS-74</b>  | 74" w/CLIP FOR PD1412 .....            | <b>15.50</b>   |
| <b>PDS-82</b>  | 82" w/CLIP FOR PD-1414/1614/1814 ..... | <b>16.00</b>   |
| <b>PDS-88</b>  | 88" w/CLIP FOR PD-2014/PD8004 .....    | <b>16.00</b>   |
| <b>PDS-97</b>  | 97" w/CLIP FOR PD-2214 .....           | <b>16.00</b>   |
| <b>PDS-101</b> | 101" w/CLIP FOR PD-2414 .....          | <b>17.00</b>   |
| <b>PDS-103</b> | 103" w/CLIP FOR PD-2614 .....          | <b>17.00</b>   |
| <b>PDS-105</b> | 105" w/CLIP FOR PD-2814 .....          | <b>17.00</b>   |
| <b>PDS-115</b> | 115" w/CLIP FOR PD-3016/3216 .....     | <b>18.00</b>   |

# MARCHING ACCESSORIES

### DRUM KEYS

|                 |   |                |
|-----------------|---|----------------|
| <b>K-030</b>    | HIGH TENSION TUNING KEY .....                 | <b>\$12.00</b> |
| <b>KGT-100H</b> | GYROTUNE KEY w/QUICK-RELEASE NECK STRAP ..... | <b>23.00</b>   |
| <b>K-080</b>    | STANDARD KEY .....                            | <b>7.00</b>    |
| <b>K-180</b>    | SPIN-TIGHT KEY .....                          | <b>30.00</b>   |

### MULTI-USE HOLDERS

|                |   |                |
|----------------|---|----------------|
| <b>MUH-10</b>  | CYMBAL HOLDER CLAMPS TO FFX EDGE RING .....     | <b>\$43.00</b> |
| <b>MUH-20</b>  | 3/8 PERC. ROD CLAMPS TO FFX TENSION POSTS ..... | <b>43.00</b>   |
| <b>MUH-10T</b> | CYMBAL HOLDER CLAMPS TO SUPERHOOP II .....      | <b>43.00</b>   |
| <b>PCS-11</b>  | MARCHING BASS DRUM ACCESSORY MOUNT .....        | <b>51.50</b>   |

### STICK & Mallet BAGS

|              |  |                |
|--------------|--|----------------|
| <b>MSB-1</b> | HOLDS 1PR. STICKS - ATTACHES w/VELCRO STRAPS ..... | <b>\$29.50</b> |
| <b>MSB-2</b> | HOLDS 2PR. STICKS - ATTACHES w/VELCRO STRAPS ..... | <b>39.50</b>   |
| <b>MMB-1</b> | FOR MALLETS - ATTACHES w/VELCRO STRAPS .....       | <b>35.95</b>   |

### QUICK-MOUNT LALO REHEARSAL PAD

|                 |   |                |
|-----------------|---|----------------|
| <b>PAD-35LA</b> | 3.5" RUBBER PRACTICE PAD - ATTACHES TO 3/8" RODS VIA THE INCLUDED CLAMP FOR ON-FIELD OR PRACTICE ROOM WARMUP, ETC. .... | <b>\$34.50</b> |
|-----------------|---|----------------|

### SOUND PROJECTORS FOR SNARE DRUMS

|              |                              |                |
|--------------|------------------------------|----------------|
| <b>SP-1</b>  | 14" WHITE w/PEARL LOGO ..... | <b>\$44.30</b> |
| <b>SP-2</b>  | 13" WHITE w/PEARL LOGO ..... | <b>41.50</b>   |
| <b>SP-1B</b> | 14" BLACK w/PEARL LOGO ..... | <b>44.30</b>   |
| <b>SP-2B</b> | 13" BLACK w/PEARL LOGO ..... | <b>41.50</b>   |

### SLING ACCESSORIES FOR SNARE DRUMS

|                  |  |                |
|------------------|--|----------------|
| <b>LR-40</b>     | LEG REST .....   | <b>\$56.50</b> |
| <b>NEW LR-60</b> | FFX LEG REST ATTACHES TO TENSION POST .....              | <b>56.50</b>   |
| <b>SLG-100</b>   | SLING w/THREE CONFIGURATIONS .....                       | <b>41.00</b>   |
| <b>CH-5S</b>     | CARRY HOOK ATTACHES TO EDGE RING .....                   | <b>13.50</b>   |
| <b>MH-30</b>     | LEVEL BAR FOR SLING-CARRIED 10 LUG SNARE DRUMS .....     | <b>7.50</b>    |
| <b>NEW MH-50</b> | FFX LEVEL BAR FOR SLING-CARRIED 12 LUG SNARE DRUMS ..... | <b>25.00</b>   |

### MALLET HOLDERS FOR BASS DRUMS

|                 |  |                |
|-----------------|--|----------------|
| <b>BMH-1</b>    | MALLET HOLDER w/TAPE - SET OF 7 .....                | <b>\$18.00</b> |
| <b>BMH-100</b>  | MALLET HOLDER REMOVABLE w/BUILT-IN RIMSHOOTERS ..... | <b>84.00</b>   |
| <b>NP-439/4</b> | REPLACEMENT CLIPS FOR BMH-100 - PACK OF 4 .....      | <b>10.50</b>   |

### TONE STRIPS FOR BASS DRUMS

|              |                            |                |
|--------------|----------------------------|----------------|
| <b>TS-14</b> | 2 x EIGHT FOOT ROLLS ..... | <b>\$22.50</b> |
|--------------|----------------------------|----------------|

### RIM SHOOTER FOR BASS DRUMS

|              |                               |                |
|--------------|-------------------------------|----------------|
| <b>BDR-1</b> | CLAMP-ON HOOP PROTECTOR ..... | <b>\$26.00</b> |
|--------------|-------------------------------|----------------|

# CHAMPIONSHIP CARBONPLY SERIES

SHELLS: SNARES & TENORS: CARBON FIBER OVER 6 PLY AFRICAN MAHOGANY  
 BASS DRUMS: CARBON FIBER OVER 6 PLY MAPLE

STANDARD LACQUER FINISH: #301 CARBON FIBER MATTE \*SPECIAL ORDER FINISHES - PLEASE ALLOW 3 TO 5 MONTHS FOR DELIVERY

SPECIAL ORDER POWDER COATING: • BLACK • WHITE • BLUE • YELLOW • RED • GREEN • ORANGE • PURPLE PLEASE ALLOW 6-8 WEEKS FOR DELIVERY (IF DRUMS ARE IN STOCK).

| SNARE DRUMS                      | POLISHED ALUMINUM | POWDER COATED | CHROME PLATED |
|----------------------------------|-------------------|---------------|---------------|
| FFXC-1412/A* 14"x12" (16.09 LBS) | \$1,342.00        | \$1,932.00    | \$1,673.00    |
| FFXC-1311/A* 13"x11" (14.55 LBS) | 1,223.00          | 1,773.00      | 1,555.00      |

HEADS: CC BATTER / ST SNARE  
 HARDWARE: POLISHED ALUMINUM  
 \*SPECIAL ORDER

| BASS DRUMS                       | STANDARD ALUMINUM | POWDER COATED | CHROME PLATED |
|----------------------------------|-------------------|---------------|---------------|
| PBDC-1414/A* 14"x14"             | \$1,151.00        | \$1,572.50    | \$1,238.00    |
| PBDC-1614/A* 16"x14" (15.43 LBS) | 1,167.00          | 1,588.00      | 1,254.00      |
| PBDC-1814/A* 18"x14" (17.19 LBS) | 1,291.00          | 1,709.00      | 1,377.00      |
| PBDC-2014/A* 20"x14" (19.18 LBS) | 1,398.00          | 1,822.00      | 1,510.00      |
| PBDC-2214/A* 22"x14" (21.16 LBS) | 1,456.00          | 1,902.00      | 1,568.00      |
| PBDC-2414/A* 24"x14" (22.48 LBS) | 1,574.00          | 1,983.00      | 1,687.00      |
| PBDC-2614/A* 26"x14" (24.03 LBS) | 1,634.00          | 2,075.50      | 1,746.00      |
| PBDC-2814/A* 28"x14" (27.55 LBS) | 1,792.00          | 2,217.50      | 1,904.00      |
| PBDC-3016/A* 30"x16" (33.06 LBS) | 2,121.00          | 2,531.00      | 2,254.00      |
| PBDC-3216/A* 32"x16" (33.29 LBS) | 2,258.00          | 2,685.50      | 2,390.00      |

\*SPECIAL ORDER  
 HEADS: SMOOTH WHITE AMBASSADORS

| SONIC-CUT TENORS                        | STANDARD ALUMINUM | POWDER COATED | CHROME PLATED |
|---|-------------------|---------------|---------------|
| PMTC-8023N/A* QUAD 8,10,12,13           | \$2,199.00        | \$2,714.50    | \$2,377.00    |
| PMTC-0234N/A* QUAD 10,12,13,14          | 2,587.00          | 3,175.00      | 2,786.00      |
| PMTC-68023N/A* QUINT 6,8,10,12,13       | 2,697.00          | 3,330.50      | 2,921.00      |
| PMTC-60234N/A* QUINT 6,10,12,13,14      | 3,085.00          | 3,791.00      | 3,330.00      |
| PMTC-668023N/A* SEXTET 6,6,8,10,12,13   | 3,195.00          | 3,946.50      | 3,465.00      |
| PMTC-660234N/A* SEXTET 6,6,10,12,13,14  | 3,583.00          | 4,407.00      | 3,874.00      |
| PMTC-680234N/A* SEXTET 6,8,10,12,13,14  | 3,597.00          | 4,419.50      | 3,863.00      |
| PTC68P/A* 6"x8" & 8"x8" SET W/MTG BRKTS | 1,010.00          | 1,244.50      | 1,077.00      |
| PTC-0608N/A* 6"x8" TOM                  | 491.00            | 609.00        | 537.00        |
| PTC-0808/A* 8"x8" TOM                   | 521.00            | 639.00        | 567.00        |
| PTC-1010/A* 10"x10" TOM                 | 602.00            | 721.00        | 648.00        |
| PTC-1212/A* 12"x12" TOM                 | 779.00            | 903.00        | 845.00        |
| PTC-1312/A* 13"x12" TOM                 | 796.00            | 918.00        | 862.00        |
| PTC-1413/A* 14"x13" TOM                 | 932.00            | 1,059.00      | 998.00        |

HEADS: CT BATTER  
 \*SPECIAL ORDER

# CHAMPIONSHIP MAPLE CARBONCORE SERIES

SHELLS: • SNARES & TENORS: 6 PLY MAPLE w/INNER PLY CARBON FIBER

STANDARD LACQUER FINISH: • #368 BLACK SILVER BURST

SPECIAL ORDER COVERED & LACQUER FINISHES: PLEASE SEE PAGE 46 IN THIS PRICE LIST \*SPECIAL ORDERS - PLEASE ALLOW 3 TO 5 MONTHS FOR DELIVERY

SPECIAL ORDER POWDER COATING: • BLACK • WHITE • BLUE • YELLOW • RED • GREEN • ORANGE • PURPLE PLEASE ALLOW 6-8 WEEKS FOR DELIVERY (IF DRUMS ARE IN STOCK).

| SNARE DRUMS                     | POLISHED ALUMINUM | POWDER COATED | CHROME PLATED |
|---------------------------------|-------------------|---------------|---------------|
| FFXIC1412/A 14"x12" (16.09 LBS) | \$1,288.00        | \$1,854.00    | \$1,619.00    |
| FFXIC1410/A 14"x10" (16.09 LBS) | 1,288.00          | 1,854.00      | 1,619.00      |
| FFXIC1311/A 13"x11" (14.55 LBS) | 1,176.00          | 1,705.00      | 1,507.00      |

HARDWARE: POLISHED ALUMINUM  
 HEADS: CC BATTER / ST SNARE

## BASS DRUMS

WE RECOMMEND 100% MAPLE CHAMPIONSHIP LACQUER BASS DRUMS WITH CARBONCORE SNARES AND TENORS. PLEASE REFER TO PAGE 32.

| SONIC-CUT TENORS                        | STANDARD ALUMINUM | POWDER COATED | CHROME PLATED |
|---|-------------------|---------------|---------------|
| PTIC8023N/A QUAD 8,10,12,13             | \$2,049.00        | \$2,529.50    | \$2,227.00    |
| PTIC0234N/A QUAD 10,12,13,14            | 2,411.00          | 2,959.00      | 2,610.00      |
| PTIC68023N/A QUINT 6,8,10,12,13         | 2,513.00          | 3,103.50      | 2,737.00      |
| PTIC60234N/A QUINT 6,10,12,13,14        | 2,875.00          | 3,533.00      | 3,120.00      |
| PTIC668023N/A SEXTET 6,6,8,10,12,13     | 2,977.00          | 3,677.50      | 3,247.00      |
| PTIC660234N/A SEXTET 6,6,10,12,13,14    | 3,339.00          | 4,107.00      | 3,630.00      |
| PTIC680234N/A SEXTET 6,8,10,12,13,14    | 3,353.00          | 4,119.50      | 3,618.00      |
| PTIC68P/A 6"x8" & 8"x8" SET W/MTG BRKTS | 942.00            | 1,160.50      | 1,007.00      |
| PTIC0608N/A 6"x8" TOM                   | 457.00            | 567.00        | 503.00        |
| PTIC0808/A 8"x8" TOM                    | 485.00            | 595.00        | 531.00        |
| PTIC1010/A 10"x10" TOM                  | 561.00            | 672.00        | 607.00        |
| PTIC1212/A 12"x12" TOM                  | 726.00            | 841.00        | 792.00        |
| PTIC1312/A 13"x12" TOM                  | 742.00            | 856.00        | 808.00        |
| PTIC1413/A 14"x13" TOM                  | 869.00            | 987.00        | 935.00        |

HEADS: CT BATTER

| SHALLOW-CUT TENORS                     | STANDARD ALUMINUM | POWDER COATED | CHROME PLATED |
|--|-------------------|---------------|---------------|
| PSIC8023N/A QUAD 8,10,12,13            | \$2,049.00        | \$2,529.50    | \$2,227.00    |
| PSIC0234N/A QUAD 10,12,13,14           | 2,411.00          | 2,959.00      | 2,610.00      |
| PSIC68023N/A QUINT 6,8,10,12,13        | 2,513.00          | 3,103.50      | 2,737.00      |
| PSIC60234N/A QUINT 6,10,12,13,14       | 2,875.00          | 3,533.00      | 3,120.00      |
| PSIC668023N/A SEXTET 6,6,8,10,12,13    | 2,977.00          | 3,677.50      | 3,247.00      |
| PSIC660234N/A SEXTET 6,6,10,12,13,14   | 3,339.00          | 4,107.00      | 3,630.00      |
| PSIC680234N/A SEXTET 6,8,10,12,13,14   | 3,353.00          | 4,119.50      | 3,618.00      |
| PTIC0808/A 8"x8" TOM - SPECIAL ORDER   | 485.00            | 595.00        | 531.00        |
| PSIC1009/A 10"x9" TOM - SPECIAL ORDER  | 561.00            | 672.00        | 607.00        |
| PSIC1210/A 12"x10" TOM - SPECIAL ORDER | 726.00            | 841.00        | 792.00        |
| PSIC1310/A 13"x10" TOM - SPECIAL ORDER | 742.00            | 856.00        | 808.00        |
| PSIC1411/A 14"x11" TOM - SPECIAL ORDER | 869.00            | 987.00        | 935.00        |

HEADS: CT BATTER

# NEW

## CHAMPIONSHIP CARBONCORE SERIES

**NEW ONE-TOUCH STRAINER**

**NEW WEIGHT REDUCTION - 2 LBS+**

SHELLS: • SNARES & TENORS: 6 PLY MAPLE w/INNER PLY CARBON FIBER

STANDARD LACQUER FINISH: • #368 BLACK SILVER BURST

**NEW SPECIAL ORDER COVERED, LACQUER & "VARSITY" FINISHES:** PLEASE SEE PAGE 46 IN THIS PRICE LIST. NOTE: "400" COVERED FINISHES ARE SUBJECT TO LACQUER PRICING. \*SPECIAL ORDERS - PLEASE ALLOW 3 TO 5 MONTHS FOR DELIVERY

**SPECIAL ORDER POWDER COATING:** • BLACK • WHITE • BLUE • YELLOW • RED • GREEN • ORANGE • PURPLE PLEASE ALLOW 6-8 WEEKS FOR DELIVERY (IF DRUMS ARE IN STOCK).

### SNARE DRUMS

|   | POLISHED ALUMINUM | POWDER COATED | CHROME PLATED |
|---|-------------------|---------------|---------------|
| FFXCC-1412/A 14"x12" (2+LBS REDUCTION) w/ONE TOUCH STRAINER ..... | \$1,352.00        | TBD           | TBD           |
| FFXCC-1311/A 13"x11" (2+LBS REDUCTION) w/ONE TOUCH STRAINER ..... | 1,176.00          | TBD           | TBD           |

HARDWARE: POLISHED ALUMINUM  
HEADS: CC BATTER / ST SNARE

### BASS DRUMS

WE RECOMMEND 100% MAPLE CHAMPIONSHIP LACQUER BASS DRUMS WITH CARBONCORE SNARES AND TENORS. PLEASE REFER TO PAGE 33.

### SONIC-CUT TENORS

|  | STANDARD ALUMINUM | POWDER COATED | CHROME PLATED |
|--|-------------------|---------------|---------------|
| PMTCC-8023/A QUAD 8,10,12,13 .....           | \$2,151.50        | TBD           | TBD           |
| PMTCC-0234/A QUAD 10,12,13,14 .....          | 2,532.00          |               |               |
| PMTCC-68023/A QUINT 6,8,10,12,13 .....       | 2,655.00          |               |               |
| PMTCC-60234/A QUINT 6,10,12,13,14 .....      | 3,035.50          |               |               |
| PMTCC-668023/A SEXTET 6,6,8,10,12,13 .....   | 3,158.50          |               |               |
| PMTCC-660234/A SEXTET 6,6,10,12,13,14 .....  | 3,539.00          |               |               |
| PMTCC-680234/A SEXTET 6,8,10,12,13,14 .....  | 3,521.50          |               |               |
| PMTCC-68/A 6"x8" & 8"x8" SET w/MTG BRKTS ... | 989.50            |               |               |
| PMTCC-0608/A 6"x8" TOM .....                 | 480.00            |               |               |
| PMTCC-0808/A 8"x8" TOM .....                 | 509.50            |               |               |
| PMTCC-1010/A 10"x10" TOM .....               | 589.50            |               |               |
| PMTCC-1212/A 12"x12" TOM .....               | 762.50            |               |               |
| PMTCC-1312/A 13"x12" TOM .....               | 779.50            |               |               |
| PMTCC-1413/A 14"x13" TOM .....               | 912.50            |               |               |

HEADS: CT BATTER

### SHALLOW-CUT TENORS

|   | STANDARD ALUMINUM | POWDER COATED | CHROME PLATED |
|---|-------------------|---------------|---------------|
| PMTCCS-8023/A QUAD 8,10,12,13 .....             | \$2,151.50        | TBD           | TBD           |
| PMTCCS-0234/A QUAD 10,12,13,14 .....            | 2,532.00          |               |               |
| PMTCCS-68023/A QUINT 6,8,10,12,13 .....         | 2,655.00          |               |               |
| PMTCCS-60234/A QUINT 6,10,12,13,14 .....        | 3,035.50          |               |               |
| PMTCCS-668023/A SEXTET 6,6,8,10,12,13 .....     | 3,158.50          |               |               |
| PMTCCS-660234/A SEXTET 6,6,10,12,13,14 .....    | 3,539.00          |               |               |
| PMTCCS-680234/A SEXTET 6,8,10,12,13,14 .....    | 3,521.50          |               |               |
| PMTCC-68/A 6"x8" & 8"x8" SET w/MTG BRKTS ...    | 989.50            |               |               |
| PMTCC-0608/A 6"x8" TOM .....                    | 480.00            |               |               |
| PMTCC-0808/A 8"x8" TOM - SPECIAL ORDER .....    | 509.50            |               |               |
| PMTCCS-1009/A 10"x9" TOM - SPECIAL ORDER .....  | 589.50            |               |               |
| PMTCCS-1210/A 12"x10" TOM - SPECIAL ORDER ..... | 762.50            |               |               |
| PMTCCS-1310/A 13"x10" TOM - SPECIAL ORDER ..... | 779.50            |               |               |
| PMTCCS-1411/A 14"x11" TOM - SPECIAL ORDER ..... | 912.50            |               |               |

HEADS: CT BATTER

# CHAMPIONSHIP MAPLE SERIES

## FFX SNARE DRUMS

SHELLS: 6 PLY 100% MAPLE

POLISHED ALUMINUM FFX HARDWARE

HEADS: CC BATTER & ST SNARE

STANDARD COVERED FINISHES: • #26 BRUSHED SILVER • #33 PURE WHITE • #46 MIDNIGHT BLACK

SPECIAL ORDER COVERED & LACQUER FINISHES: PLEASE SEE PAGE 46 IN THIS PRICE LIST. NOTE: "400" COVERED FINISHES ARE SUBJECT TO LACQUER PRICING. \*SPECIAL ORDERS - PLEASE ALLOW 3 TO 5 MONTHS FOR DELIVERY

SPECIAL ORDER POWDER COATING: • BLACK • WHITE • BLUE • YELLOW • RED • GREEN • ORANGE • PURPLE PLEASE ALLOW 6-8 WEEKS FOR DELIVERY (IF DRUMS ARE IN STOCK).

| COVERED - IN STOCK |             |                    | POLISHED ALUMINUM | POWDER COATED | CHROME PLATED | LACQUER - *SPECIAL ORDER |                    |            | POLISHED ALUMINUM | POWDER COATED | CHROME PLATED |
|--------------------|-------------|--------------------|-------------------|---------------|---------------|--------------------------|--------------------|------------|-------------------|---------------|---------------|
| BEST SELLER        | FFX-1412/A  | 14"x12" (16.9 LBS) | \$1,092.50        | \$1,552.50    | \$1,447.00    | FFXL-1412/A*             | 14"x12" (16.9 LBS) | \$1,255.00 | \$1,769.00        | \$1,587.00    |               |
|                    | FFX-1410/A* | 14"x10" (16.9 LBS) | 1,092.50          | 1,552.50      | 1,447.00      | FFXL-1410/A*             | 14"x10" (16.9 LBS) | 1,255.00   | 1,769.00          | 1,587.00      |               |
| BEST SELLER        | FFX-1311/A  | 13"x11" (14 LBS)   | 960.00            | 1,438.50      | 1,312.50      | FFXL-1311/A*             | 13"x11" (14 LBS)   | 1,120.00   | 1,624.50          | 1,452.00      |               |

### COVERED FFX SNARE DRUM / PEARL CARRIER / STAND / CASE PACKAGES

| FFX -1412/A PACKAGES | FFX-1412/A DRUM | CXS-1 CARRIER | MSS-3000 STAND | PD-1412 CASE | POLISHED ALUMINUM |
|----------------------|-----------------|---------------|----------------|--------------|-------------------|
| FFX-1412/ACN         | X               | -             | -              | X            | \$1,240.00        |
| FFX-1412/AXN         | X               | X             | -              | -            | 1,532.50          |
| FFX-1412/AXCN        | X               | X             | -              | X            | 1,680.00          |
| FFX-1412/AXSN        | X               | X             | X              | -            | 1,814.50          |
| FFX-1412/AXCSN       | X               | X             | X              | X            | 1,962.00          |
| FFX -1410/A PACKAGES | FFX-1410/A DRUM | CXS-1 CARRIER | MSS-3000 STAND | PD-1412 CASE | POLISHED ALUMINUM |
| FFX-1410/ACN         | X               | -             | -              | X            | \$1,240.00        |
| FFX-1410/AXN         | X               | X             | -              | -            | 1,532.50          |
| FFX-1410/AXCN        | X               | X             | -              | X            | 1,680.00          |
| FFX-1410/AXSN        | X               | X             | X              | -            | 1,814.50          |
| FFX-1410/AXCSN       | X               | X             | X              | X            | 1,962.00          |
| FFX -1311/A PACKAGES | FFX-1311/A DRUM | CXS-1 CARRIER | MSS-3000 STAND | PD-1412 CASE | POLISHED ALUMINUM |
| FFX-1311/ACN         | X               | -             | -              | X            | \$1,107.50        |
| FFX-1311/AXN         | X               | X             | -              | -            | 1,400.00          |
| FFX-1311/AXCN        | X               | X             | -              | X            | 1,547.50          |
| FFX-1311/AXSN        | X               | X             | X              | -            | 1,682.00          |
| FFX-1311/AXCSN       | X               | X             | X              | X            | 1,829.50          |

# NEW

# CHAMPIONSHIP MAPLE SERIES

## FFX SNARE DRUMS

NEW ONE-TOUCH STRAINER

NEW WEIGHT REDUCTION - 2LBS+

SHELLS: 6 PLY 100% MAPLE

POLISHED ALUMINUM FFX HARDWARE

HEADS: CC BATTER & ST SNARE

STANDARD COVERED FINISHES: • #33 PURE WHITE • #46 MIDNIGHT BLACK

NEW STANDARD LACQUER FINISH: • #360 SILVER SPARKLE

NEW SPECIAL ORDER COVERED, LACQUER & "VARSITY" FINISHES: PLEASE SEE PAGE 46 IN THIS PRICE LIST. NOTE: "400" COVERED FINISHES ARE SUBJECT TO LACQUER PRICING. \*SPECIAL ORDERS - PLEASE ALLOW 3 TO 5 MONTHS FOR DELIVERY

SPECIAL ORDER POWDER COATING: • BLACK • WHITE • BLUE • YELLOW • RED • GREEN • ORANGE • PURPLE PLEASE ALLOW 6-8 WEEKS FOR DELIVERY (IF DRUMS ARE IN STOCK).

| COVERED     |             | POLISHED ALUMINUM  | POWDER COATED | CHROME PLATED | LACQUER |              | POLISHED ALUMINUM  | POWDER COATED | CHROME PLATED |     |
|-------------|-------------|--------------------|---------------|---------------|---------|--------------|--------------------|---------------|---------------|-----|
| BEST SELLER | FFXM-1412/A | 14"x12" (14.5 LBS) | \$1,147.50    | TBD           | TBD     | FFXML-1412/A | 14"x12" (14.5 LBS) | \$1,318.00    | TBD           | TBD |
| BEST SELLER | FFXM-1311/A | 13"x11" (11.5 LBS) | 1,008.00      |               |         | FFXML-1311/A | 13"x11" (11.5 LBS) | 1,176.00      |               |     |

### COVERED FFX SNARE DRUM / PEARL CARRIER / STAND / CASE PACKAGES

| FFXM -1412/A PACKAGES | FFXM-1412/A DRUM | CXS-1 CARRIER | MSS-3000 STAND | PD-1412 CASE | POLISHED ALUMINUM |
|-----------------------|------------------|---------------|----------------|--------------|-------------------|
| FFXM-1412/AC          | X                | -             | -              | X            | TBD               |
| FFXM-1412/AX          | X                | X             | -              | -            |                   |
| FFXM-1412/AXC         | X                | X             | -              | X            |                   |
| FFXM-1412/AXS         | X                | X             | X              | -            |                   |
| FFXM-1412/AXCS        | X                | X             | X              | X            |                   |
| FFXM -1311/A PACKAGES | FFXM-1311/A DRUM | CXS-1 CARRIER | MSS-3000 STAND | PD-1412 CASE | POLISHED ALUMINUM |
| FFXM-1311/AC          | X                | -             | -              | X            | TBD               |
| FFXM-1311/AX          | X                | X             | -              | -            |                   |
| FFXM-1311/AXC         | X                | X             | -              | X            |                   |
| FFXM-1311/AXS         | X                | X             | X              | -            |                   |
| FFXM-1311/AXCS        | X                | X             | X              | X            |                   |

# CHAMPIONSHIP MAPLE SERIES

## BASS DRUMS

SHELLS: 6 PLY 100% MAPLE

HEADS: REMO SMOOTH WHITE AMBASSADORS

STANDARD COVERED FINISHES: • #26 BRUSHED SILVER • #33 PURE WHITE • #46 MIDNIGHT BLACK

SPECIAL ORDER COVERED & LACQUER FINISHES: PLEASE SEE PAGE 46 IN THIS PRICE LIST. NOTE: "400" COVERED FINISHES ARE SUBJECT TO LACQUER PRICING. \*SPECIAL ORDERS - PLEASE ALLOW 3 TO 5 MONTHS FOR DELIVERY

SPECIAL ORDER POWDER COATING: • BLACK • WHITE • BLUE • YELLOW • RED • GREEN • ORANGE • PURPLE PLEASE ALLOW 6-8 WEEKS FOR DELIVERY (IF DRUMS ARE IN STOCK).

|             | COVERED - IN STOCK          | STANDARD ALUMINUM | POWDER COATED | CHROME PLATED |
|-------------|-----------------------------|-------------------|---------------|---------------|
| BEST SELLER | PBD-1414 14"x14" (13 LBS)   | \$812.00          | \$1,205.50    | \$921.00      |
| BEST SELLER | PBD-1614 16"x14" (14.6 LBS) | 846.00            | 1,235.50      | 955.50        |
| BEST SELLER | PBD-1814 18"x14" (16.4 LBS) | 957.50            | 1,359.50      | 1,070.00      |
| BEST SELLER | PBD-2014 20"x14" (19 LBS)   | 1,030.50          | 1,434.00      | 1,171.00      |
| BEST SELLER | PBD-2214 22"x14" (20.1 LBS) | 1,064.00          | 1,459.50      | 1,205.50      |
| BEST SELLER | PBD-2414 24"x14" (21.5 LBS) | 1,099.00          | 1,485.50      | 1,241.50      |
|             | PBD-2614 26"x14" (22.8 LBS) | 1,219.00          | 1,626.50      | 1,364.00      |
|             | PBD-2814 28"x14" (24.3 LBS) | 1,253.00          | 1,653.50      | 1,399.00      |
|             | PBD-3016 30"x16" (29 LBS)   | 1,476.00          | 1,802.50      | 1,648.50      |
|             | PBD-3216 32"x16" (29.4 LBS) | 1,558.00          | 1,963.50      | 1,732.50      |

|  | LACQUER - *SPECIAL ORDER      | STANDARD ALUMINUM | POWDER COATED | CHROME PLATED |
|--|-------------------------------|-------------------|---------------|---------------|
|  | PBDL-1414* 14"x14" (13 LBS)   | \$1,065.00        | \$1,459.00    | \$1,152.00    |
|  | PBDL-1614* 16"x14" (14.6 LBS) | 1,082.00          | 1,457.00      | 1,168.00      |
|  | PBDL-1814* 18"x14" (16.4 LBS) | 1,154.00          | 1,574.50      | 1,241.00      |
|  | PBDL-2014* 20"x14" (19 LBS)   | 1,232.00          | 1,660.00      | 1,344.00      |
|  | PBDL-2214* 22"x14" (20.1 LBS) | 1,260.00          | 1,651.00      | 1,372.00      |
|  | PBDL-2414* 24"x14" (21.5 LBS) | 1,355.00          | 1,746.50      | 1,467.00      |
|  | PBDL-2614* 26"x14" (22.8 LBS) | 1,444.00          | 1,931.00      | 1,556.00      |
|  | PBDL-2814* 28"x14" (24.3 LBS) | 1,521.00          | 2,023.50      | 1,634.00      |
|  | PBDL-3016* 30"x16" (29 LBS)   | 1,867.00          | 2,229.00      | 2,000.00      |
|  | PBDL-3216* 32"x16" (29.4 LBS) | 1,978.00          | 2,342.00      | 2,111.00      |

### COVERED BASS DRUM / PEARL CARRIER / STAND / CASE PACKAGES

| PBD-1414 PACKAGES | PBD-1414 DRUM | CXB-1 CARRIER | MBS-3000 STAND | PD-1414 CASE | STANDARD ALUMINUM |
|-------------------|---------------|---------------|----------------|--------------|-------------------|
| PBD1414CN         | X             | -             | -              | X            | \$959.50          |
| PBD1414XN         | X             | X             | -              | -            | 1,252.00          |
| PBD1414XCN        | X             | X             | -              | X            | 1,399.50          |
| PBD1414XSN        | X             | X             | X              | -            | 1,562.50          |
| PBD1414XCSN       | X             | X             | X              | X            | 1,710.00          |

| PBD-1614 PACKAGES | PBD-1614 DRUM | CXB-1 CARRIER | MBS-3000 STAND | PD-1614 CASE | STANDARD ALUMINUM |
|-------------------|---------------|---------------|----------------|--------------|-------------------|
| PBD1614CN         | X             | -             | -              | X            | \$1,005.00        |
| PBD1614XN         | X             | X             | -              | -            | 1,286.00          |
| PBD1614XCN        | X             | X             | -              | X            | 1,445.00          |
| PBD1614XSN        | X             | X             | X              | -            | 1,596.50          |
| PBD1614XCSN       | X             | X             | X              | X            | 1,755.50          |

| PBD-1814 PACKAGES | PBD-1814 DRUM | CXB-1 CARRIER | MBS-3000 STAND | PD-1814 CASE | STANDARD ALUMINUM |
|-------------------|---------------|---------------|----------------|--------------|-------------------|
| PBD1814CN         | X             | -             | -              | X            | \$1,122.00        |
| PBD1814XN         | X             | X             | -              | -            | 1,397.50          |
| PBD1814XCN        | X             | X             | -              | X            | 1,562.00          |
| PBD1814XSN        | X             | X             | X              | -            | 1,708.00          |
| PBD1814XCSN       | X             | X             | X              | X            | 1,872.50          |

| PBD-2014 PACKAGES | PBD-2014 DRUM | CXB-1 CARRIER | MBS-3000 STAND | PD-2014 CASE | STANDARD ALUMINUM |
|-------------------|---------------|---------------|----------------|--------------|-------------------|
| PBD2014CN         | X             | -             | -              | X            | \$1,212.00        |
| PBD2014XN         | X             | X             | -              | -            | 1,470.50          |
| PBD2014XCN        | X             | X             | -              | X            | 1,652.00          |
| PBD2014XSN        | X             | X             | X              | -            | 1,781.00          |
| PBD2014XCSN       | X             | X             | X              | X            | 1,962.50          |

| PBD-2214 PACKAGES | PBD-2214 DRUM | CXB-1 CARRIER | MBS-3000 STAND | PD-2214 CASE | STANDARD ALUMINUM |
|-------------------|---------------|---------------|----------------|--------------|-------------------|
| PBD2214CN         | X             | -             | -              | X            | \$1,268.50        |
| PBD2214XN         | X             | X             | -              | -            | 1,504.00          |
| PBD2214XCN        | X             | X             | -              | X            | 1,708.50          |
| PBD2214XSN        | X             | X             | X              | -            | 1,814.50          |
| PBD2214XCSN       | X             | X             | X              | X            | 2,019.00          |

| PBD-2414 PACKAGES | PBD-2414 DRUM | CXB-1 CARRIER | MBS-3000 STAND | PD-2414 CASE | STANDARD ALUMINUM |
|-------------------|---------------|---------------|----------------|--------------|-------------------|
| PBD2414CN         | X             | -             | -              | X            | \$1,320.50        |
| PBD2414XN         | X             | X             | -              | -            | 1,539.00          |
| PBD2414XCN        | X             | X             | -              | X            | 1,760.50          |
| PBD2414XSN        | X             | X             | X              | -            | 1,849.50          |
| PBD2414XCSN       | X             | X             | X              | X            | 2,071.00          |

| PBD-2614 PACKAGES | PBD-2614 DRUM | CXB-1 CARRIER | MBS-3000 STAND | PD-2614 CASE | STANDARD ALUMINUM |
|-------------------|---------------|---------------|----------------|--------------|-------------------|
| PBD2614CN         | X             | -             | -              | X            | \$1,457.50        |
| PBD2614XN         | X             | X             | -              | -            | 1,659.00          |
| PBD2614XCN        | X             | X             | -              | X            | 1,897.50          |
| PBD2614XSN        | X             | X             | X              | -            | 1,969.50          |
| PBD2614XCSN       | X             | X             | X              | X            | 2,208.00          |

| PBD-2814 PACKAGES | PBD-2814 DRUM | CXB-1 CARRIER | MBS-3000 STAND | PD-2814 CASE | STANDARD ALUMINUM |
|-------------------|---------------|---------------|----------------|--------------|-------------------|
| PBD2814CN         | X             | -             | -              | X            | \$1,503.00        |
| PBD2814XN         | X             | X             | -              | -            | 1,693.00          |
| PBD2814XCN        | X             | X             | -              | X            | 1,943.00          |
| PBD2814XSN        | X             | X             | X              | -            | 2,003.50          |
| PBD2814XCSN       | X             | X             | X              | X            | 2,253.50          |

| PBD-3016 PACKAGES | PBD-3016 DRUM | CXB-1 CARRIER | MBS-3000 STAND | PD-3016 CASE | STANDARD ALUMINUM |
|-------------------|---------------|---------------|----------------|--------------|-------------------|
| PBD3016CN         | X             | -             | -              | X            | \$1,731.50        |
| PBD3016XN         | X             | X             | -              | -            | 1,916.00          |
| PBD3016XCN        | X             | X             | -              | X            | 2,171.50          |
| PBD3016XSN        | X             | X             | X              | -            | 2,226.50          |
| PBD3016XCSN       | X             | X             | X              | X            | 2,482.00          |

| PBD-3216 PACKAGES | PBD-3216 DRUM | CXB-1 CARRIER | MBS-3000 STAND | PD-3216 CASE | STANDARD ALUMINUM |
|-------------------|---------------|---------------|----------------|--------------|-------------------|
| PBD-3216CN        | X             | -             | -              | X            | \$1,819.00        |
| PBD-3216XN        | X             | X             | -              | -            | 1,998.00          |
| PBD-3216XCN       | X             | X             | -              | X            | 2,259.00          |
| PBD-3216XSN       | X             | X             | X              | -            | 2,308.50          |
| PBD-3216XCSN      | X             | X             | X              | X            | 2,569.50          |



# NEW

# CHAMPIONSHIP MAPLE SERIES

## BASS DRUMS

SHELLS: 6 PLY 100% MAPLE

HEADS: REMO SMOOTH WHITE AMBASSADORS

STANDARD COVERED FINISHES: • #33 PURE WHITE • #46 MIDNIGHT BLACK

**NEW** STANDARD LACQUER FINISH: • #360 SILVER SPARKLE

**NEW** SPECIAL ORDER COVERED, LACQUER & "VARSITY" FINISHES: PLEASE SEE PAGE 46 IN THIS PRICE LIST. NOTE: "400" COVERED FINISHES ARE SUBJECT TO LACQUER PRICING. \*SPECIAL ORDERS - PLEASE ALLOW 3 TO 5 MONTHS FOR DELIVERY

SPECIAL ORDER POWDER COATING: • BLACK • WHITE • BLUE • YELLOW • RED • GREEN • ORANGE • PURPLE PLEASE ALLOW 6-8 WEEKS FOR DELIVERY (IF DRUMS ARE IN STOCK).

|                            | COVERED                              | STANDARD ALUMINUM | POWDER COATED | CHROME PLATED |
|----------------------------|--------------------------------------|-------------------|---------------|---------------|
| <small>BEST SELLER</small> | PBDM-1414/A 14"x14" (13 LBS) .....   | \$853.00          | TBD           | TBD           |
| <small>BEST SELLER</small> | PBDM-1614/A 16"x14" (14.6 LBS) ..... | 888.50            |               |               |
| <small>BEST SELLER</small> | PBDM-1814/A 18"x14" (16.4 LBS) ..... | 1,005.50          |               |               |
| <small>BEST SELLER</small> | PBDM-2014/A 20"x14" (19 LBS) .....   | 1,082.50          |               |               |
| <small>BEST SELLER</small> | PBDM-2214/A 22"x14" (20.1 LBS) ..... | 1,117.50          |               |               |
| <small>BEST SELLER</small> | PBDM-2414/A 24"x14" (21.5 LBS) ..... | 1,154.00          |               |               |
|                            | PBDM-2614/A 26"x14" (22.8 LBS) ..... | 1,280.00          |               |               |
|                            | PBDM-2814/A 28"x14" (24.3 LBS) ..... | 1,316.00          |               |               |
|                            | PBDM-3016/A 30"x16" (29 LBS) .....   | 1,550.00          |               |               |
|                            | PBDM-3216/A 32"x16" (29.4 LBS) ..... | 1,636.00          |               |               |

|  | LACQUER                               | STANDARD ALUMINUM | POWDER COATED | CHROME PLATED |
|--|---------------------------------------|-------------------|---------------|---------------|
|  | PBDML-1414/A 14"x14" (13 LBS) .....   | \$1,118.50        | TBD           | \$TBD         |
|  | PBDML-1614/A 16"x14" (14.6 LBS) ..... | 1,136.50          |               |               |
|  | PBDML-1814/A 18"x14" (16.4 LBS) ..... | 1,212.00          |               |               |
|  | PBDML-2014/A 20"x14" (19 LBS) .....   | 1,294.00          |               |               |
|  | PBDML-2214/A 22"x14" (20.1 LBS) ..... | 1,323.00          |               |               |
|  | PBDML-2414/A 24"x14" (21.5 LBS) ..... | 1,423.00          |               |               |
|  | PBDML-2614/A 26"x14" (22.8 LBS) ..... | 1,516.50          |               |               |
|  | PBDML-2814/A 28"x14" (24.3 LBS) ..... | 1,597.50          |               |               |
|  | PBDML-3016/A 30"x16" (29 LBS) .....   | 1,960.50          |               |               |
|  | PBDML-3216/A 32"x16" (29.4 LBS) ..... | 2,077.00          |               |               |

### COVERED BASS DRUM / PEARL CARRIER / STAND / CASE PACKAGES

| PBDM-1414/A PACKAGES | PBDM-1414/A DRUM | CXB-1 CARRIER | MBS-3000 STAND | PD-1414 CASE | STANDARD ALUMINUM |
|----------------------|------------------|---------------|----------------|--------------|-------------------|
| PBDM-1414/AC         | X                | -             | -              | X            | TBD               |
| PBDM-1414/AX         | X                | X             | -              | -            |                   |
| PBDM-1414/AXC        | X                | X             | -              | X            |                   |
| PBDM-1414/AXS        | X                | X             | X              | -            |                   |
| PBDM-1414/AXCS       | X                | X             | X              | X            |                   |

| PBDM-1614/A PACKAGES | PBDM-1614/A DRUM | CXB-1 CARRIER | MBS-3000 STAND | PD-1614 CASE | STANDARD ALUMINUM |
|----------------------|------------------|---------------|----------------|--------------|-------------------|
| PBDM-1614/AC         | X                | -             | -              | X            | TBD               |
| PBDM-1614/AX         | X                | X             | -              | -            |                   |
| PBDM-1614/AXC        | X                | X             | -              | X            |                   |
| PBDM-1614/AXS        | X                | X             | X              | -            |                   |
| PBDM-1614/AXCS       | X                | X             | X              | X            |                   |

| PBDM-1814/A PACKAGES | PBDM-1814/A DRUM | CXB-1 CARRIER | MBS-3000 STAND | PD-1814 CASE | STANDARD ALUMINUM |
|----------------------|------------------|---------------|----------------|--------------|-------------------|
| PBDM-1814/AC         | X                | -             | -              | X            | TBD               |
| PBDM-1814/AX         | X                | X             | -              | -            |                   |
| PBDM-1814/AXC        | X                | X             | -              | X            |                   |
| PBDM-1814/AXS        | X                | X             | X              | -            |                   |
| PBDM-1814/AXCS       | X                | X             | X              | X            |                   |

| PBDM-2014/A PACKAGES | PBDM-2014/A DRUM | CXB-1 CARRIER | MBS-3000 STAND | PD-2014 CASE | STANDARD ALUMINUM |
|----------------------|------------------|---------------|----------------|--------------|-------------------|
| PBDM-2014/AC         | X                | -             | -              | X            | TBD               |
| PBDM-2014/AX         | X                | X             | -              | -            |                   |
| PBDM-2014/AXC        | X                | X             | -              | X            |                   |
| PBDM-2014/AXS        | X                | X             | X              | -            |                   |
| PBDM-2014/AXCS       | X                | X             | X              | X            |                   |

| PBDM-2214/A PACKAGES | PBDM-2214/A DRUM | CXB-1 CARRIER | MBS-3000 STAND | PD-2214 CASE | STANDARD ALUMINUM |
|----------------------|------------------|---------------|----------------|--------------|-------------------|
| PBDM-2214/AC         | X                | -             | -              | X            | TBD               |
| PBDM-2214/AX         | X                | X             | -              | -            |                   |
| PBDM-2214/AXC        | X                | X             | -              | X            |                   |
| PBDM-2214/AXS        | X                | X             | X              | -            |                   |
| PBDM-2214/AXCS       | X                | X             | X              | X            |                   |

| PBDM-2414/A PACKAGES | PBDM-2414/A DRUM | CXB-1 CARRIER | MBS-3000 STAND | PD-2414 CASE | STANDARD ALUMINUM |
|----------------------|------------------|---------------|----------------|--------------|-------------------|
| PBDM-2414/AC         | X                | -             | -              | X            | TBD               |
| PBDM-2414/AX         | X                | X             | -              | -            |                   |
| PBDM-2414/AXC        | X                | X             | -              | X            |                   |
| PBDM-2414/AXS        | X                | X             | X              | -            |                   |
| PBDM-2414/AXCS       | X                | X             | X              | X            |                   |

| PBDM-2614/A PACKAGES | PBDM-2614/A DRUM | CXB-1 CARRIER | MBS-3000 STAND | PD-2614 CASE | STANDARD ALUMINUM |
|----------------------|------------------|---------------|----------------|--------------|-------------------|
| PBDM-2614/AC         | X                | -             | -              | X            | TBD               |
| PBDM-2614/AX         | X                | X             | -              | -            |                   |
| PBDM-2614/AXC        | X                | X             | -              | X            |                   |
| PBDM-2614/AXS        | X                | X             | X              | -            |                   |
| PBDM-2614/AXCS       | X                | X             | X              | X            |                   |

| PBDM-2814/A PACKAGES | PBDM-2814/A DRUM | CXB-1 CARRIER | MBS-3000 STAND | PD-2814 CASE | STANDARD ALUMINUM |
|----------------------|------------------|---------------|----------------|--------------|-------------------|
| PBDM-2814/AC         | X                | -             | -              | X            | TBD               |
| PBDM-2814/AX         | X                | X             | -              | -            |                   |
| PBDM-2814/AXC        | X                | X             | -              | X            |                   |
| PBDM-2814/AXS        | X                | X             | X              | -            |                   |
| PBDM-2814/AXCS       | X                | X             | X              | X            |                   |

| PBDM-3016/A PACKAGES | PBDM-3016/A DRUM | CXB-1 CARRIER | MBS-3000 STAND | PD-3016 CASE | STANDARD ALUMINUM |
|----------------------|------------------|---------------|----------------|--------------|-------------------|
| PBDM-3016/AC         | X                | -             | -              | X            | TBD               |
| PBDM-3016/AX         | X                | X             | -              | -            |                   |
| PBDM-3016/AXC        | X                | X             | -              | X            |                   |
| PBDM-3016/AXS        | X                | X             | X              | -            |                   |
| PBDM-3016/AXCS       | X                | X             | X              | X            |                   |

| PBDM-3216/A PACKAGES | PBDM-3216/A DRUM | CXB-1 CARRIER | MBS-3000 STAND | PD-3216 CASE | STANDARD ALUMINUM |
|----------------------|------------------|---------------|----------------|--------------|-------------------|
| PBDM-3216/AC         | X                | -             | -              | X            | TBD               |
| PBDM-3216/AX         | X                | X             | -              | -            |                   |
| PBDM-3216/AXC        | X                | X             | -              | X            |                   |
| PBDM-3216/AXS        | X                | X             | X              | -            |                   |
| PBDM-3216/AXCS       | X                | X             | X              | X            |                   |

# CHAMPIONSHIP MAPLE SERIES

## SONIC-CUT TENORS

SHELLS: 6 PLY 100% MAPLE w/REINFORCEMENT RINGS  
HEADS: CT

STANDARD COVERED FINISHES: • #26 BRUSHED SILVER • #33 PURE WHITE • #46 MIDNIGHT BLACK

SPECIAL ORDER COVERED & LACQUER FINISHES: PLEASE SEE PAGE 46 IN THIS PRICE LIST. NOTE: "400" COVERED FINISHES ARE SUBJECT TO LACQUER PRICING. \*SPECIAL ORDERS - PLEASE ALLOW 3 TO 5 MONTHS FOR DELIVERY

SPECIAL ORDER POWDER COATING: • BLACK • WHITE • BLUE • YELLOW • RED • GREEN • ORANGE • PURPLE PLEASE ALLOW 6-8 WEEKS FOR DELIVERY (IF DRUMS ARE IN STOCK).

| COVERED - IN STOCK |   | STANDARD ALUMINUM | POWDER COATED | CHROME PLATED |
|--------------------|---|-------------------|---------------|---------------|
| PMT-8023N/A        | QUAD 8,10,12,13 (22.4 LBS) .....        | \$1,515.00        | \$2,074.50    | \$1,736.00    |
| PMT-0234N/A        | QUAD 10,12,13,14 (26 LBS) .....         | 1,705.00          | 2,223.00      | 1,951.00      |
| PMT-68023N/A       | QUINT 6,8,10,12,13 (25.3 LBS) .....     | 1,884.00          | 2,516.50      | 2,161.00      |
| PMT-60234N/A       | QUINT 6,10,12,13,14 (28.9 LBS) .....    | 2,074.00          | 2,665.00      | 2,376.00      |
| PMT-668023N/A      | SEXTET 6,6,8,10,12,13 (28.2 LBS) .....  | 2,253.00          | 2,958.50      | 2,586.00      |
| PMT-660234N/A      | SEXTET 6,6,10,12,13,14 (31.8 LBS) ..... | 2,443.00          | 3,107.00      | 2,801.00      |
| PMT-680234N/A      | SEXTET 6,8,10,12,13,14 (31.8 LBS) ..... | 2,351.00          | 2,974.00      | 2,681.00      |
| PT-68P/A           | 6"x8" & 8"x8" SET w/MTG BRKTS .....     | 646.00            | 751.00        | 730.00        |
| PT-0608N/A         | 6"x8" TOM .....                         | 362.00            | 435.00        | 418.00        |
| PT-0808/A          | 8"x8" TOM - UNDRILLED .....             | 374.50            | 454.00        | 430.50        |
| PT-1010/A          | 10"x10" TOM - UNDRILLED .....           | 411.50            | 497.50        | 468.50        |
| PT-1212/A          | 12"x12" TOM - UNDRILLED .....           | 468.50            | 578.00        | 548.50        |
| PT-1312/A          | 13"x12" TOM - UNDRILLED .....           | 525.00            | 640.50        | 606.00        |
| PT-1413/A          | 14"x13" TOM - UNDRILLED .....           | 582.50            | 705.00        | 665.00        |

| LACQUER - *SPECIAL ORDER |   | STANDARD ALUMINUM | POWDER COATED | CHROME PLATED |
|--------------------------|---|-------------------|---------------|---------------|
| PMTL-8023N/A*            | QUAD 8,10,12,13 (22.4 LBS) .....        | \$1,851.00        | \$2,260.50    | \$2,029.00    |
| PMTL-0234N/A*            | QUAD 10,12,13,14 (26 LBS) .....         | 2,070.00          | 2,472.00      | 2,269.00      |
| PMTL-68023N/A*           | QUINT 6,8,10,12,13 (25.3 LBS) .....     | 2,301.00          | 2,807.00      | 2,525.00      |
| PMTL-60234N/A*           | QUINT 6,10,12,13,14 (28.9 LBS) .....    | 2,520.00          | 3,018.50      | 2,765.00      |
| PMTL-668023N/A*          | SEXTET 6,6,8,10,12,13 (28.2 LBS) .....  | 2,751.00          | 3,353.50      | 3,021.00      |
| PMTL-660234N/A*          | SEXTET 6,6,10,12,13,14 (31.8 LBS) ..... | 2,970.00          | 3,565.00      | 3,261.00      |
| PMTL-680234N/A*          | SEXTET 6,8,10,12,13,14 (31.8 LBS) ..... | 2,852.00          | 3,315.50      | 3,117.00      |
| PTL-68P/A*               | 6"x8" & 8"x8" SET w/MTG BRKTS .....     | 782.00            | 843.50        | 848.00        |
| PTL-0608N/A*             | 6"x8" TOM .....                         | 443.00            | 539.50        | 489.00        |
| PTL-0808/A*              | 8"x8" TOM - UNDRILLED .....             | 477.00            | 573.00        | 523.00        |
| PTL-1010/A*              | 10"x10" TOM - UNDRILLED .....           | 516.00            | 612.00        | 561.00        |
| PTL-1212/A*              | 12"x12" TOM - UNDRILLED .....           | 589.00            | 681.00        | 655.00        |
| PTL-1312/A*              | 13"x12" TOM - UNDRILLED .....           | 661.00            | 752.00        | 728.00        |
| PTL-1413/A*              | 14"x13" TOM - UNDRILLED .....           | 706.00            | 795.50        | 773.00        |

### COVERED TENORS / PEARL CARRIER / STAND / CASE PACKAGES

#### QUADS

| PMT-8023N/A | QUAD PACKAGES  | PMT-8023N/A DRUMS | CXT-1 CARRIER | MTS-3000 STAND | PD-8004 CASE | STANDARD ALUMINUM | PMT-0234N/A | QUAD PACKAGES  | PMT-0234N/A DRUMS | CXT-1 CARRIER | MTS-3000 STAND | PD-8004 CASE | STANDARD ALUMINUM |
|-------------|----------------|-------------------|---------------|----------------|--------------|-------------------|-------------|----------------|-------------------|---------------|----------------|--------------|-------------------|
|             |                |                   |               |                |              |                   |             |                |                   |               |                |              |                   |
|             | PMT-8023/ACN   | X                 | -             | -              | X            | \$1,798.50        |             | PMT-0234/ACN   | X                 | -             | -              | X            | \$1,988.50        |
|             | PMT-8023/AXN   | X                 | X             | -              | -            | 2,005.50          |             | PMT-0234/AXN   | X                 | X             | -              | -            | 2,195.50          |
|             | PMT-8023/AXCN  | X                 | X             | -              | X            | 2,289.00          |             | PMT-0234/AXCN  | X                 | X             | -              | X            | 2,479.00          |
|             | PMT-8023/AXSN  | X                 | X             | X              | -            | 2,321.50          |             | PMT-0234/AXSN  | X                 | X             | X              | -            | 2,511.50          |
|             | PMT-8023/AXCSN | X                 | X             | X              | X            | 2,605.00          |             | PMT-0234/AXCSN | X                 | X             | X              | X            | 2,795.00          |

#### QUINTS

| PMT-68023N/A | QUINT PACKAGES  | PMT-68023N/A DRUMS | CXT-1 CARRIER | MTS-3000 STAND | PD-8004 CASE | STANDARD ALUMINUM | PMT-60234N/A | QUINT PACKAGES  | PMT-60234N/A DRUMS | CXT-1 CARRIER | MTS-3000 STAND | PD-8004 CASE | STANDARD ALUMINUM |
|--------------|-----------------|--------------------|---------------|----------------|--------------|-------------------|--------------|-----------------|--------------------|---------------|----------------|--------------|-------------------|
|              |                 |                    |               |                |              |                   |              |                 |                    |               |                |              |                   |
|              | PMT-68023/ACN   | X                  | -             | -              | X            | \$2,167.50        |              | PMT-60234/ACN   | X                  | -             | -              | X            | \$2,357.50        |
|              | PMT-68023/AXN   | X                  | X             | -              | -            | 2,374.50          |              | PMT-60234/AXN   | X                  | X             | -              | -            | 2,564.50          |
|              | PMT-68023/AXCN  | X                  | X             | -              | X            | 2,658.00          |              | PMT-60234/AXCN  | X                  | X             | -              | X            | 2,848.00          |
|              | PMT-68023/AXSN  | X                  | X             | X              | -            | 2,690.50          |              | PMT-60234/AXSN  | X                  | X             | X              | -            | 2,880.50          |
|              | PMT-68023/AXCSN | X                  | X             | X              | X            | 2,974.00          |              | PMT-60234/AXCSN | X                  | X             | X              | X            | 3,164.00          |

#### SEXTETS

| PMT-668023N/A | SEXTET PACKAGES  | PMT-668023N/A DRUMS | CXT-1 CARRIER | MTS-3000 STAND | PD-8004 CASE | STANDARD ALUMINUM | PMT-660234N/A | SEXTET PACKAGES  | PMT-660234N/A DRUMS | CXT-1 CARRIER | MTS-3000 STAND | PD-8004 CASE | STANDARD ALUMINUM |
|---------------|------------------|---------------------|---------------|----------------|--------------|-------------------|---------------|------------------|---------------------|---------------|----------------|--------------|-------------------|
|               |                  |                     |               |                |              |                   |               |                  |                     |               |                |              |                   |
|               | PMT-668023/ACN   | X                   | -             | -              | X            | \$2,536.50        |               | PMT-660234/ACN   | X                   | -             | -              | X            | \$2,726.50        |
|               | PMT-668023/AXN   | X                   | X             | -              | -            | 2,743.50          |               | PMT-660234/AXN   | X                   | X             | -              | -            | 2,933.50          |
|               | PMT-668023/AXCN  | X                   | X             | -              | X            | 3,027.00          |               | PMT-660234/AXCN  | X                   | X             | -              | X            | 3,217.00          |
|               | PMT-668023/AXSN  | X                   | X             | X              | -            | 3,059.50          |               | PMT-660234/AXSN  | X                   | X             | X              | -            | 3,249.50          |
|               | PMT-668023/AXCSN | X                   | X             | X              | X            | 3,343.00          |               | PMT-660234/AXCSN | X                   | X             | X              | X            | 3,533.00          |
|               | PMT-680234/ACN   | X                   | -             | -              | X            | \$2,634.50        |               | PMT-680234/ACN   | X                   | -             | -              | X            | \$2,634.50        |
|               | PMT-680234/AXN   | X                   | X             | -              | -            | 2,841.50          |               | PMT-680234/AXN   | X                   | X             | -              | -            | 2,841.50          |
|               | PMT-680234/AXCN  | X                   | X             | -              | X            | 3,125.00          |               | PMT-680234/AXCN  | X                   | X             | -              | X            | 3,125.00          |
|               | PMT-680234/AXSN  | X                   | X             | X              | -            | 3,157.50          |               | PMT-680234/AXSN  | X                   | X             | X              | -            | 3,157.50          |
|               | PMT-680234/AXCSN | X                   | X             | X              | X            | 3,441.00          |               | PMT-680234/AXCSN | X                   | X             | X              | X            | 3,441.00          |

# NEW

# CHAMPIONSHIP MAPLE SERIES

## SONIC-CUT TENORS

SHELLS: 6 PLY 100% MAPLE w/REINFORCEMENT RINGS

HEADS: CT

STANDARD COVERED FINISHES: • #33 PURE WHITE • #46 MIDNIGHT BLACK

NEW STANDARD LACQUER FINISH: • #360 SILVER SPARKLE

NEW SPECIAL ORDER COVERED, LACQUER & "VARSITY" FINISHES: PLEASE SEE PAGE 46 IN THIS PRICE LIST. NOTE: "400" COVERED FINISHES ARE SUBJECT TO LACQUER PRICING. \*SPECIAL ORDERS - PLEASE ALLOW 3 TO 5 MONTHS FOR DELIVERY

SPECIAL ORDER POWDER COATING: • BLACK • WHITE • BLUE • YELLOW • RED • GREEN • ORANGE • PURPLE PLEASE ALLOW 6-8 WEEKS FOR DELIVERY (IF DRUMS ARE IN STOCK).

| COVERED        |   | STANDARD ALUMINUM | POWDER COATED | CHROME PLATED |
|----------------|---|-------------------|---------------|---------------|
| PMTM-8023/A    | QUAD 8,10,12,13 (22.4 LBS) .....        | \$1,591.00        | TBD           | TBD           |
| PMTM-0234/A    | QUAD 10,12,13,14 (26 LBS) .....         | 1,790.50          |               |               |
| PMTM-68023/A   | QUINT 6,8,10,12,13 (25.3 LBS) .....     | 1,995.00          |               |               |
| PMTM-60234/A   | QUINT 6,10,12,13,14 (28.9 LBS) .....    | 2,194.50          |               |               |
| PMTM-668023/A  | SEXTET 6,6,8,10,12,13 (28.2 LBS) .....  | 2,399.00          |               |               |
| PMTM-660234/A  | SEXTET 6,6,10,12,13,14 (31.8 LBS) ..... | 2,598.50          |               |               |
| PMTM-680234/A  | SEXTET 6,8,10,12,13,14 (31.8 LBS) ..... | 2,469.00          |               |               |
| PMTM-68/A      | 6"x8" & 8"x8" SET w/MTG BRKTS .....     | 678.50            |               |               |
| PMTM-0608/A    | 6"x8" TOM .....                         | 380.50            |               |               |
| PMTM-0808/A    | 8"x8" TOM - UNDRILLED .....             | 393.50            |               |               |
| PMTM-1010/A    | 10"x10" TOM - UNDRILLED .....           | 432.50            |               |               |
| PMTM-1212/A    | 12"x12" TOM - UNDRILLED .....           | 492.00            |               |               |
| PMTM-1312/A    | 13"x12" TOM - UNDRILLED .....           | 551.50            |               |               |
| PMTM-1413/A    | 14"x13" TOM - UNDRILLED .....           | 612.00            |               |               |
| LACQUER        |   | STANDARD ALUMINUM | POWDER COATED | CHROME PLATED |
| PMTML-8023/A   | QUAD 8,10,12,13 (22.4 LBS) .....        | \$1,944.00        | TBD           | TBD           |
| PMTML-0234/A   | QUAD 10,12,13,14 (26 LBS) .....         | 2,173.50          |               |               |
| PMTML-68023/A  | QUINT 6,8,10,12,13 (25.3 LBS) .....     | 2,433.00          |               |               |
| PMTML-60234/A  | QUINT 6,10,12,13,14 (28.9 LBS) .....    | 2,662.50          |               |               |
| PMTML-668023/A | SEXTET 6,6,8,10,12,13 (28.2 LBS) .....  | 2,922.00          |               |               |
| PMTML-660234/A | SEXTET 6,6,10,12,13,14 (31.8 LBS) ..... | 3,151.50          |               |               |
| PMTML-680234/A | SEXTET 6,8,10,12,13,14 (31.8 LBS) ..... | 2,995.00          |               |               |
| PMTML-68/A     | 6"x8" & 8"x8" SET w/MTG BRKTS .....     | 821.50            |               |               |
| PMTML-0608/A   | 6"x8" TOM .....                         | 465.50            |               |               |
| PMTML-0808/A   | 8"x8" TOM - UNDRILLED .....             | 501.00            |               |               |
| PMTML-1010/A   | 10"x10" TOM - UNDRILLED .....           | 542.00            |               |               |
| PMTML-1212/A   | 12"x12" TOM - UNDRILLED .....           | 618.50            |               |               |
| PMTML-1312/A   | 13"x12" TOM - UNDRILLED .....           | 694.50            |               |               |
| PMTML-1413/A   | 14"x13" TOM - UNDRILLED .....           | 741.50            |               |               |

### COVERED TENORS / PEARL CARRIER / STAND / CASE PACKAGES

#### QUADS

**PMTM-8023/A**

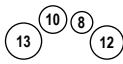

| QUAD PACKAGES  | PMTM-8023/A DRUMS | CXT-1 CARRIER | MTS-3000 STAND | PD-8004 CASE | STANDARD ALUMINUM |
|----------------|-------------------|---------------|----------------|--------------|-------------------|
| PMTM-8023/AC   | X                 | -             | -              | X            | TBD               |
| PMTM-8023/AX   | X                 | X             | -              | -            |                   |
| PMTM-8023/AXC  | X                 | X             | -              | X            |                   |
| PMTM-8023/AXS  | X                 | X             | X              | -            |                   |
| PMTM-8023/AXCS | X                 | X             | X              | X            |                   |

**PMTM-0234/A**

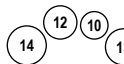

| QUAD PACKAGES  | PMTM-0234/A DRUMS | CXT-1 CARRIER | MTS-3000 STAND | PD-8004 CASE | STANDARD ALUMINUM |
|----------------|-------------------|---------------|----------------|--------------|-------------------|
| PMTM-0234/AC   | X                 | -             | -              | X            | TBD               |
| PMTM-0234/AX   | X                 | X             | -              | -            |                   |
| PMTM-0234/AXC  | X                 | X             | -              | X            |                   |
| PMTM-0234/AXS  | X                 | X             | X              | -            |                   |
| PMTM-0234/AXCS | X                 | X             | X              | X            |                   |

#### QUINTS

**PMTM-68023/A**

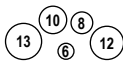

| QUINT PACKAGES  | PMTM-68023/A DRUMS | CXT-1 CARRIER | MTS-3000 STAND | PD-8004 CASE | STANDARD ALUMINUM |
|-----------------|--------------------|---------------|----------------|--------------|-------------------|
| PMTM-68023/AC   | X                  | -             | -              | X            | TBD               |
| PMTM-68023/AX   | X                  | X             | -              | -            |                   |
| PMTM-68023/AXC  | X                  | X             | -              | X            |                   |
| PMTM-68023/AXS  | X                  | X             | X              | -            |                   |
| PMTM-68023/AXCS | X                  | X             | X              | X            |                   |

**PMTM-60234/A**

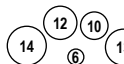

| QUINT PACKAGES  | PMTM-60234/A DRUMS | CXT-1 CARRIER | MTS-3000 STAND | PD-8004 CASE | STANDARD ALUMINUM |
|-----------------|--------------------|---------------|----------------|--------------|-------------------|
| PMTM-60234/AC   | X                  | -             | -              | X            | TBD               |
| PMTM-60234/AX   | X                  | X             | -              | -            |                   |
| PMTM-60234/AXC  | X                  | X             | -              | X            |                   |
| PMTM-60234/AXS  | X                  | X             | X              | -            |                   |
| PMTM-60234/AXCS | X                  | X             | X              | X            |                   |

#### SEXTETS

**PMTM-668023/A**

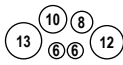

| SEXTET PACKAGES  | PMT-668023/A DRUMS | CXT-1 CARRIER | MTS-3000 STAND | PD-8004 CASE | STANDARD ALUMINUM |
|------------------|--------------------|---------------|----------------|--------------|-------------------|
| PMTM-668023/AC   | X                  | -             | -              | X            | TBD               |
| PMTM-668023/AX   | X                  | X             | -              | -            |                   |
| PMTM-668023/AXC  | X                  | X             | -              | X            |                   |
| PMTM-668023/AXS  | X                  | X             | X              | -            |                   |
| PMTM-668023/AXCS | X                  | X             | X              | X            |                   |

**PMTM-660234/A**

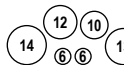

| SEXTET PACKAGES  | PMT-660234/A DRUMS | CXT-1 CARRIER | MTS-3000 STAND | PD-8004 CASE | STANDARD ALUMINUM |
|------------------|--------------------|---------------|----------------|--------------|-------------------|
| PMTM-660234/AC   | X                  | -             | -              | X            | TBD               |
| PMTM-660234/AX   | X                  | X             | -              | -            |                   |
| PMTM-660234/AXC  | X                  | X             | -              | X            |                   |
| PMTM-660234/AXS  | X                  | X             | X              | -            |                   |
| PMTM-660234/AXCS | X                  | X             | X              | X            |                   |

**PMTM-680234/A**

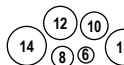

| SEXTET PACKAGES  | PMTM-680234/A DRUMS | CXT-1 CARRIER | MTS-3000 STAND | PD-8004 CASE | STANDARD ALUMINUM |
|------------------|---------------------|---------------|----------------|--------------|-------------------|
| PMTM-680234/AC   | X                   | -             | -              | X            | TBD               |
| PMTM-680234/AX   | X                   | X             | -              | -            |                   |
| PMTM-680234/AXC  | X                   | X             | -              | X            |                   |
| PMTM-680234/AXS  | X                   | X             | X              | -            |                   |
| PMTM-680234/AXCS | X                   | X             | X              | X            |                   |

# CHAMPIONSHIP MAPLE SERIES

## SHALLOW-CUT TENORS

SHELLS: 6 PLY 100% MAPLE w/REINFORCEMENT RINGS

HEADS: CT

STANDARD COVERED FINISHES: • #26 BRUSHED SILVER • #33 PURE WHITE • #46 MIDNIGHT BLACK

SPECIAL ORDER COVERED & LACQUER FINISHES: PLEASE SEE PAGE 46 IN THIS PRICE LIST. NOTE: "400" COVERED FINISHES ARE SUBJECT TO LACQUER PRICING. \*SPECIAL ORDERS - PLEASE ALLOW 3 TO 5 MONTHS FOR DELIVERY

SPECIAL ORDER POWDER COATING: • BLACK • WHITE • BLUE • YELLOW • RED • GREEN • ORANGE • PURPLE PLEASE ALLOW 6-8 WEEKS FOR DELIVERY (IF DRUMS ARE IN STOCK).

| COVERED - IN STOCK |   | STANDARD ALUMINUM | POWDER COATED | CHROME PLATED |
|--------------------|---|-------------------|---------------|---------------|
| PSMT-8023N/A       | QUAD 8,10,12,13 (22.4 LBS) .....        | \$1,515.00        | \$2,074.50    | \$1,736.00    |
| PSMT-0234N/A       | QUAD 10,12,13,14 (26 LBS) .....         | 1,705.00          | 2,223.00      | 1,951.00      |
| PSMT-68023N/A      | QUINT 6,8,10,12,13 (25.3 LBS) .....     | 1,884.00          | 2,516.50      | 2,161.00      |
| PSMT-60234N/A      | QUINT 6,10,12,13,14 (28.9 LBS) .....    | 2,074.00          | 2,665.00      | 2,376.00      |
| PSMT-668023N/A     | SEXTET 6,6,8,10,12,13 (28.2 LBS) .....  | 2,253.00          | 2,958.50      | 2,586.00      |
| PSMT-660234N/A     | SEXTET 6,6,10,12,13,14 (31.8 LBS) ..... | 2,443.00          | 3,107.00      | 2,801.00      |
| PSMT-680234N/A     | SEXTET 6,8,10,12,13,14 (31.8 LBS) ..... | 2,351.00          | 2,974.00      | 2,681.00      |
| PT68P/A            | 6"x8" & 8"x8" SET w/MTG BRKTS .....     | 646.00            | 751.00        | 730.00        |
| PT0608N/A          | 6"x8" TOM .....                         | 362.00            | 435.00        | 418.00        |
| PT0808/A           | 8"x8" TOM - UNDRILLED .....             | 374.50            | 454.00        | 430.50        |
| PST1009/A          | 10"x9" TOM - UNDRILLED .....            | 411.50            | 497.50        | 468.50        |
| PST1210/A          | 12"x10" TOM - UNDRILLED .....           | 468.50            | 578.00        | 548.50        |
| PST1310/A          | 13"x10" TOM - UNDRILLED .....           | 525.00            | 640.50        | 606.00        |
| PST1411/A          | 14"x11" TOM - UNDRILLED .....           | 582.50            | 705.00        | 665.00        |

| LACQUER - *SPECIAL ORDER |   | STANDARD ALUMINUM | POWDER COATED | CHROME PLATED |
|--------------------------|---|-------------------|---------------|---------------|
| PSMTL-8023N/AC*          | QUAD 8,10,12,13 (22.4 LBS) .....        | \$1,851.00        | \$2,260.50    | \$2,029.00    |
| PSMTL-0234N/A*           | QUAD 10,12,13,14 (26 LBS) .....         | 2,070.00          | 2,472.00      | 2,269.00      |
| PSMTL-68023N/A*          | QUINT 6,8,10,12,13 (25.3 LBS) .....     | 2,301.00          | 2,807.00      | 2,525.00      |
| PSMTL-60234N/A*          | QUINT 6,10,12,13,14 (28.9 LBS) .....    | 2,520.00          | 3,018.50      | 2,765.00      |
| PSMTL-668023N/A*         | SEXTET 6,6,8,10,12,13 (28.2 LBS) .....  | 2,751.00          | 3,353.50      | 3,021.00      |
| PSMTL-660234N/A*         | SEXTET 6,6,10,12,13,14 (31.8 LBS) ..... | 2,970.00          | 3,565.00      | 3,261.00      |
| PSMTL-680234N/A*         | SEXTET 6,8,10,12,13,14 (31.8 LBS) ..... | 2,852.00          | 3,315.50      | 3,117.00      |
| PTL-68P/A*               | 6"x8" & 8"x8" SET w/MTG BRKTS .....     | 782.00            | 843.50        | 848.00        |
| PTL-0608N/*A             | 6"x8" TOM .....                         | 443.00            | 539.50        | 489.00        |
| PTL-0808/A*              | 8"x8" TOM - UNDRILLED .....             | 477.00            | 573.00        | 523.00        |
| PSTL-1009/A*             | 10"x9" TOM - UNDRILLED .....            | 516.00            | 612.00        | 561.00        |
| PSTL-1210/A*             | 12"x10" TOM - UNDRILLED .....           | 589.00            | 681.00        | 655.00        |
| PSTL-1310/A*             | 13"x10" TOM - UNDRILLED .....           | 661.00            | 752.00        | 728.00        |
| PSTL-1411/A*             | 14"x11" TOM - UNDRILLED .....           | 706.00            | 795.50        | 773.00        |

### COVERED SHALLOW-CUT TENORS / PEARL CARRIER / CASE PACKAGES

#### QUADS

**PSMT-8023N/A**

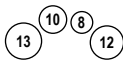

| QUAD PACKAGES   | PSMT-8023N/A DRUMS | CXT-1 CARRIER | MTS-3000 STAND | PD-8004 CASE | STANDARD ALUMINUM |
|-----------------|--------------------|---------------|----------------|--------------|-------------------|
| PSMT-8023/ACN   | X                  | -             | -              | X            | \$1,798.50        |
| PSMT-8023/AXN   | X                  | X             | -              | -            | 2,005.50          |
| PSMT-8023/AXCN  | X                  | X             | -              | X            | 2,289.00          |
| PSMT-8023/AXSN  | X                  | X             | X              | -            | 2,321.50          |
| PSMT-8023/AXCSN | X                  | X             | X              | X            | 2,605.00          |

**PSMT-0234N/A**

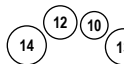

| QUAD PACKAGES   | PSMT-0234N/A DRUMS | CXT-1 CARRIER | MTS-3000 STAND | PD-8004 CASE | STANDARD ALUMINUM |
|-----------------|--------------------|---------------|----------------|--------------|-------------------|
| PSMT-0234/ACN   | X                  | -             | -              | X            | \$1,988.50        |
| PSMT-0234/AXN   | X                  | X             | -              | -            | 2,195.50          |
| PSMT-0234/AXCN  | X                  | X             | -              | X            | 2,479.00          |
| PSMT-0234/AXSN  | X                  | X             | X              | -            | 2,511.50          |
| PSMT-0234/AXCSN | X                  | X             | X              | X            | 2,795.00          |

#### QUINTS

**PSMT-68023N/A**

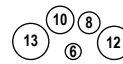

| QUINT PACKAGES   | PSMT-68023N/A DRUMS | CXT-1 CARRIER | MTS-3000 STAND | PD-8004 CASE | STANDARD ALUMINUM |
|------------------|---------------------|---------------|----------------|--------------|-------------------|
| PSMT-68023/ACN   | X                   | -             | -              | X            | \$2,167.50        |
| PSMT-68023/AXN   | X                   | X             | -              | -            | 2,374.50          |
| PSMT-68023/AXCN  | X                   | X             | -              | X            | 2,658.00          |
| PSMT-68023/AXSN  | X                   | X             | X              | -            | 2,690.50          |
| PSMT-68023/AXCSN | X                   | X             | X              | X            | 2,974.00          |

**PSMT-60234N/A**

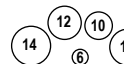

| QUINT PACKAGES   | PSMT-60234N/A DRUMS | CXT-1 CARRIER | MTS-3000 STAND | PD-8004 CASE | STANDARD ALUMINUM |
|------------------|---------------------|---------------|----------------|--------------|-------------------|
| PSMT-60234/ACN   | X                   | -             | -              | X            | \$2,357.50        |
| PSMT-60234/AXN   | X                   | X             | -              | -            | 2,564.50          |
| PSMT-60234/AXCN  | X                   | X             | -              | X            | 2,848.00          |
| PSMT-60234/AXSN  | X                   | X             | X              | -            | 2,880.50          |
| PSMT-60234/AXCSN | X                   | X             | X              | X            | 3,164.00          |

#### SEXTETS

**PSMT-668023N/A**

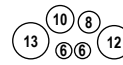

| SEXTET PACKAGES   | PSMT-668023N/A DRUMS | CXT-1 CARRIER | MTS-3000 STAND | PD-8004 CASE | STANDARD ALUMINUM |
|-------------------|----------------------|---------------|----------------|--------------|-------------------|
| PSMT-668023/ACN   | X                    | -             | -              | X            | \$2,536.50        |
| PSMT-668023/AXN   | X                    | X             | -              | -            | 2,743.50          |
| PSMT-668023/AXCN  | X                    | X             | -              | X            | 3,027.00          |
| PSMT-668023/AXSN  | X                    | X             | X              | -            | 3,059.50          |
| PSMT-668023/AXCSN | X                    | X             | X              | X            | 3,343.00          |

**PSMT-660234N/A**

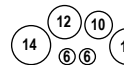

| SEXTET PACKAGES   | PSMT-660234N/A DRUMS | CXT-1 CARRIER | MTS-3000 STAND | PD-8004 CASE | STANDARD ALUMINUM |
|-------------------|----------------------|---------------|----------------|--------------|-------------------|
| PSMT-660234/ACN   | X                    | -             | -              | X            | \$2,726.50        |
| PSMT-660234/AXN   | X                    | X             | -              | -            | 2,933.50          |
| PSMT-660234/AXCN  | X                    | X             | -              | X            | 3,217.00          |
| PSMT-660234/AXSN  | X                    | X             | X              | -            | 3,249.50          |
| PSMT-660234/AXCSN | X                    | X             | X              | X            | 3,533.00          |

**PSMT-680234N/A**

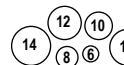

| SEXTET PACKAGES   | PSMT-680234N/A DRUMS | CXT-1 CARRIER | MTS-3000 STAND | PD-8004 CASE | STANDARD ALUMINUM |
|-------------------|----------------------|---------------|----------------|--------------|-------------------|
| PSMT-680234/ACN   | X                    | -             | -              | X            | \$2,634.50        |
| PSMT-680234/AXN   | X                    | X             | -              | -            | 2,841.50          |
| PSMT-680234/AXCN  | X                    | X             | -              | X            | 3,125.00          |
| PSMT-680234/AXSN  | X                    | X             | X              | -            | 3,157.50          |
| PSMT-680234/AXCSN | X                    | X             | X              | X            | 3,441.00          |

# NEW

# CHAMPIONSHIP MAPLE SERIES

## SHALLOW-CUT TENORS

SHELLS: 6 PLY 100% MAPLE w/REINFORCEMENT RINGS

HEADS: CT

STANDARD COVERED FINISHES: • #33 PURE WHITE • #46 MIDNIGHT BLACK

NEW STANDARD LACQUER FINISH: • #360 SILVER SPARKLE

NEW SPECIAL ORDER COVERED, LACQUER & "VARSITY" FINISHES: PLEASE SEE PAGE 46 IN THIS PRICE LIST. NOTE: "400" COVERED FINISHES ARE SUBJECT TO LACQUER PRICING. \*SPECIAL ORDERS - PLEASE ALLOW 3 TO 5 MONTHS FOR DELIVERY

SPECIAL ORDER POWDER COATING: • BLACK • WHITE • BLUE • YELLOW • RED • GREEN • ORANGE • PURPLE PLEASE ALLOW 6-8 WEEKS FOR DELIVERY (IF DRUMS ARE IN STOCK).

| COVERED        |   | STANDARD ALUMINUM | POWDER COATED | CHROME PLATED |
|----------------|---|-------------------|---------------|---------------|
| PMTMS-8023/A   | QUAD 8,10,12,13 (22.4 LBS) .....        | \$1,591.00        | TBD           | TBD           |
| PMTMS-0234/A   | QUAD 10,12,13,14 (26 LBS) .....         | 1,790.50          |               |               |
| PMTMS-68023/A  | QUINT 6,8,10,12,13 (25.3 LBS) .....     | 1,995.00          |               |               |
| PMTMS-60234/A  | QUINT 6,10,12,13,14 (28.9 LBS) .....    | 2,194.50          |               |               |
| PMTMS-668023/A | SEXTET 6,6,8,10,12,13 (28.2 LBS) .....  | 2,399.00          |               |               |
| PMTMS-660234/A | SEXTET 6,6,10,12,13,14 (31.8 LBS) ..... | 2,598.50          |               |               |
| PMTMS-680234/A | SEXTET 6,8,10,12,13,14 (31.8 LBS) ..... | 2,469.00          |               |               |
| PMTM-68/A      | 6"x8" & 8"x8" SET w/MTG BRKTS .....     | 678.50            |               |               |
| PMTM-0608/A    | 6"x8" TOM .....                         | 380.50            |               |               |
| PMTM-0808/A    | 8"x8" TOM - UNDRILLED .....             | 393.50            |               |               |
| PMTMS-1009/A   | 10"x9" TOM - UNDRILLED .....            | 432.50            |               |               |
| PMTMS-1210/A   | 12"x10" TOM - UNDRILLED .....           | 492.00            |               |               |
| PMTMS-1310/A   | 13"x10" TOM - UNDRILLED .....           | 551.50            |               |               |
| PMTMS-1411/A   | 14"x11" TOM - UNDRILLED .....           | 612.00            |               |               |

  

| LACQUER         |   | STANDARD ALUMINUM | POWDER COATED | CHROME PLATED |
|-----------------|---|-------------------|---------------|---------------|
| PMTMSL-8023/A   | QUAD 8,10,12,13 (22.4 LBS) .....        | \$1,944.00        | TBD           | TBD           |
| PMTMSL-0234/A   | QUAD 10,12,13,14 (26 LBS) .....         | 2,173.50          |               |               |
| PMTMSL-68023/A  | QUINT 6,8,10,12,13 (25.3 LBS) .....     | 2,433.00          |               |               |
| PMTMSL-60234/A  | QUINT 6,10,12,13,14 (28.9 LBS) .....    | 2,662.50          |               |               |
| PMTMSL-668023/A | SEXTET 6,6,8,10,12,13 (28.2 LBS) .....  | 2,922.00          |               |               |
| PMTMSL-660234/A | SEXTET 6,6,10,12,13,14 (31.8 LBS) ..... | 3,151.50          |               |               |
| PMTMSL-680234/A | SEXTET 6,8,10,12,13,14 (31.8 LBS) ..... | 2,995.00          |               |               |
| PMTML-68/A      | 6"x8" & 8"x8" SET w/MTG BRKTS .....     | 821.50            |               |               |
| PMTML-0608/A    | 6"x8" TOM .....                         | 465.50            |               |               |
| PMTML-0808/A    | 8"x8" TOM - UNDRILLED .....             | 501.00            |               |               |
| PMTMSL-1009/A   | 10"x9" TOM - UNDRILLED .....            | 542.00            |               |               |
| PMTMSL-1210/A   | 12"x10" TOM - UNDRILLED .....           | 618.50            |               |               |
| PMTMSL-1310/A   | 13"x10" TOM - UNDRILLED .....           | 694.50            |               |               |
| PMTMSL-1411/A   | 14"x11" TOM - UNDRILLED .....           | 741.50            |               |               |

### COVERED SHALLOW-CUT TENORS / PEARL CARRIER / CASE PACKAGES

#### QUADS

**PMTMS-8023/A**

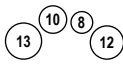

| QUAD PACKAGES   | PMTMS-8023/A DRUMS | CXT-1 CARRIER | MTS-3000 STAND | PD-8004 CASE | STANDARD ALUMINUM |
|-----------------|--------------------|---------------|----------------|--------------|-------------------|
| PMTMS-8023/AC   | X                  | -             | -              | X            | TBD               |
| PMTMS-8023/AX   | X                  | X             | -              | -            |                   |
| PMTMS-8023/AXC  | X                  | X             | -              | X            |                   |
| PMTMS-8023/AXS  | X                  | X             | X              | -            |                   |
| PMTMS-8023/AXCS | X                  | X             | X              | X            |                   |

**PMTMS-0234/A**

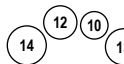

| QUAD PACKAGES   | PMTMS-0234/A DRUMS | CXT-1 CARRIER | MTS-3000 STAND | PD-8004 CASE | STANDARD ALUMINUM |
|-----------------|--------------------|---------------|----------------|--------------|-------------------|
| PMTMS-0234/AC   | X                  | -             | -              | X            | TBD               |
| PMTMS-0234/AX   | X                  | X             | -              | -            |                   |
| PMTMS-0234/AXC  | X                  | X             | -              | X            |                   |
| PMTMS-0234/AXS  | X                  | X             | X              | -            |                   |
| PMTMS-0234/AXCS | X                  | X             | X              | X            |                   |

#### QUINTS

**PMTMS-68023/A**

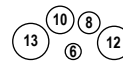

| QUINT PACKAGES   | PSMT-68023/A DRUMS | CXT-1 CARRIER | MTS-3000 STAND | PD-8004 CASE | STANDARD ALUMINUM |
|------------------|--------------------|---------------|----------------|--------------|-------------------|
| PMTMS-68023/AC   | X                  | -             | -              | X            | TBD               |
| PMTMS-68023/AX   | X                  | X             | -              | -            |                   |
| PMTMS-68023/AXC  | X                  | X             | -              | X            |                   |
| PMTMS-68023/AXS  | X                  | X             | X              | -            |                   |
| PMTMS-68023/AXCS | X                  | X             | X              | X            |                   |

**PMTMS-60234/A**

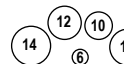

| QUINT PACKAGES   | PSMT-60234/A DRUMS | CXT-1 CARRIER | MTS-3000 STAND | PD-8004 CASE | STANDARD ALUMINUM |
|------------------|--------------------|---------------|----------------|--------------|-------------------|
| PMTMS-60234/AC   | X                  | -             | -              | X            | TBD               |
| PMTMS-60234/AX   | X                  | X             | -              | -            |                   |
| PMTMS-60234/AXC  | X                  | X             | -              | X            |                   |
| PMTMS-60234/AXS  | X                  | X             | X              | -            |                   |
| PMTMS-60234/AXCS | X                  | X             | X              | X            |                   |

#### SEXTETS

**PMTMS-668023/A**

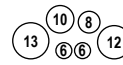

| SEXTET PACKAGES   | PSMT-668023/A DRUMS | CXT-1 CARRIER | MTS-3000 STAND | PD-8004 CASE | STANDARD ALUMINUM |
|-------------------|---------------------|---------------|----------------|--------------|-------------------|
| PMTMS-668023/AC   | X                   | -             | -              | X            | TBD               |
| PMTMS-668023/AX   | X                   | X             | -              | -            |                   |
| PMTMS-668023/AXC  | X                   | X             | -              | X            |                   |
| PMTMS-668023/AXS  | X                   | X             | X              | -            |                   |
| PMTMS-668023/AXCS | X                   | X             | X              | X            |                   |

**PMTMS-660234/A**

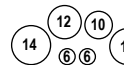

| SEXTET PACKAGES   | PMTMS-660234/A DRUMS | CXT-1 CARRIER | MTS-3000 STAND | PD-8004 CASE | STANDARD ALUMINUM |
|-------------------|----------------------|---------------|----------------|--------------|-------------------|
| PMTMS-660234/AC   | X                    | -             | -              | X            | TBD               |
| PMTMS-660234/AX   | X                    | X             | -              | -            |                   |
| PMTMS-660234/AXC  | X                    | X             | -              | X            |                   |
| PMTMS-660234/AXS  | X                    | X             | X              | -            |                   |
| PMTMS-660234/AXCS | X                    | X             | X              | X            |                   |

**PMTMS-680234/A**

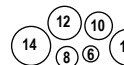

| SEXTET PACKAGES   | PSMT-680234/A DRUMS | CXT-1 CARRIER | MTS-3000 STAND | PD-8004 CASE | STANDARD ALUMINUM |
|-------------------|---------------------|---------------|----------------|--------------|-------------------|
| PMTMS-680234/AC   | X                   | -             | -              | X            | TBD               |
| PMTMS-680234/AX   | X                   | X             | -              | -            |                   |
| PMTMS-680234/AXC  | X                   | X             | -              | X            |                   |
| PMTMS-680234/AXS  | X                   | X             | X              | -            |                   |
| PMTMS-680234/AXCS | X                   | X             | X              | X            |                   |

# CHAMPIONSHIP TRADITIONAL SINGLE TENORS

SHELLS: 6 PLY 100% MAPLE w/REINFORCEMENT RINGS      STANDARD COVERED FINISHES: • #26 BRUSHED SILVER • #33 PURE WHITE • #46 MIDNIGHT BLACK      HEADS: CT  
 SPECIAL ORDER POWDER COATING: • BLACK • WHITE • BLUE • YELLOW • RED • GREEN • ORANGE • PURPLE      PLEASE ALLOW 6-8 WEEKS FOR DELIVERY (IF DRUMS ARE IN STOCK).

## COVERED

|                         |   | ALUMINUM | POWDER COATED | CHROME   |
|-------------------------|---|----------|---------------|----------|
| <b>PTD-1412N/A</b>      | 14"x12" TRADITIONAL TENOR w/FULLY ROUNDED BEARING EDGES, LIGHT-WEIGHT ALUMINUM SINGLE LUGS, SUPERHOOP II (10.4 LBS) ..... | \$617.50 | \$711.00      | \$648.50 |
| <b>PTD-1512N/A</b>      | 15"x12" TRADITIONAL TENOR w/FULLY ROUNDED BEARING EDGES, LIGHT-WEIGHT ALUMINUM SINGLE LUGS, SUPERHOOP II (10.9 LBS) ..... | 680.50   | 783.00        | 715.00   |
| <b>PTD-1614N/A</b>      | 16"x14" TRADITIONAL TENOR w/FULLY ROUNDED BEARING EDGES, LIGHT-WEIGHT ALUMINUM SINGLE LUGS, SUPERHOOP II (11.8 LBS) ..... | 718.00   | 826.00        | 754.00   |
| <b>NEW PTDM-1412/A*</b> | 14"x12" TRADITIONAL TENOR w/FULLY ROUNDED BEARING EDGES, LIGHT-WEIGHT ALUMINUM SINGLE LUGS, SUPERHOOP II (10.4 LBS) ..... | 648.50   | TBD           | TBD      |
| <b>NEW PTDM-1512/A*</b> | 15"x12" TRADITIONAL TENOR w/FULLY ROUNDED BEARING EDGES, LIGHT-WEIGHT ALUMINUM SINGLE LUGS, SUPERHOOP II (10.9 LBS) ..... | 715.00   | TBD           | TBD      |
| <b>NEW PTDM-1614/A*</b> | 16"x14" TRADITIONAL TENOR w/FULLY ROUNDED BEARING EDGES, LIGHT-WEIGHT ALUMINUM SINGLE LUGS, SUPERHOOP II (11.8 LBS) ..... | 754.00   | TBD           | TBD      |

\*PTDM TENORS ONLY AVAILABLE IN #33 PURE WHITE & #46 MIDNIGHT BLACK COVERED FINISHES

# COMPETITOR SERIES MARCHING DRUMS

SHELLS: 6 PLY POPLAR/KAPUR  
 HEADS: CC BATTER, ST SNARE  
 STANDARD HARDWARE FINISHES: POLISHED ALUMINUM  
 STANDARD COVERED FINISHES: • #33 PURE WHITE • #46 MIDNIGHT BLACK

## SNARE DRUMS

HEADS: CC BATTER & ST SNARE SIDE

|                    |  |          |
|--------------------|--|----------|
| <b>CMSX-1412/C</b> | 14"x12" HIGH TENSION (13.9 LBS) #33 OR #46 ..... | \$764.00 |
| <b>CMSX-1311/C</b> | 13"x11" HIGH TENSION (12.9 LBS) #33 OR #46 ..... | 696.00   |
| <b>CMS-1412/C</b>  | 14"x12" TRADITIONAL (11.8 LBS) #33 OR #46 .....  | 515.00   |
| <b>CMS-1309/C</b>  | 13"x9" TRADITIONAL (<10 LBS) #33 OR #46 .....    | 442.00   |

POLISHED ALUMINUM HW ON CMSX SNARE DRUMS  
 POPLAR / KAPUR SHELLS

## COMPETITOR SNARE DRUM / PEARL CARRIER PACKAGES

| PACKAGE #            | DRUM        | SIZE    | CARRIER | MSRP       |
|----------------------|-------------|---------|---------|------------|
| <b>CMSX-1412/CXN</b> | CMSX-1412/C | 14"x12" | MXS-1   | \$1,035.00 |
| <b>CMSX-1311/CXN</b> | CMSX-1311/C | 13"x11" | MXS-1   | 967.00     |
| <b>CMS-1412/CXN</b>  | CMS-1412/C  | 14"x12" | MXS-1   | 786.00     |
| <b>CMS-1309/CXN</b>  | CMS-1309/C  | 13"x9"  | MXS-1   | 713.00     |

## BASS DRUMS

HEADS: REMO SMOOTH WHITE AMBASSADORS

|                    |   |          |
|--------------------|---|----------|
| <b>CMB-1414N/C</b> | 14"x14" (11.5 LBS) #33 PURE WHITE OR #46 MIDNIGHT BLACK ..... | \$577.50 |
| <b>CMB-1614N/C</b> | 16"x14" (14.1 LBS) #33 PURE WHITE OR #46 MIDNIGHT BLACK ..... | 583.50   |
| <b>CMB-1814N/C</b> | 18"x14" (15.5 LBS) #33 PURE WHITE OR #46 MIDNIGHT BLACK ..... | 640.00   |
| <b>CMB-2014N/C</b> | 20"x14" (16.2 LBS) #33 PURE WHITE OR #46 MIDNIGHT BLACK ..... | 690.00   |
| <b>CMB-2214N/C</b> | 22"x14" (18.9 LBS) #33 PURE WHITE OR #46 MIDNIGHT BLACK ..... | 764.00   |
| <b>CMB-2414N/C</b> | 24"x14" (20.4 LBS) #33 PURE WHITE OR #46 MIDNIGHT BLACK ..... | 797.50   |
| <b>CMB-2614N/C</b> | 26"x14" (21.0 LBS) #33 PURE WHITE OR #46 MIDNIGHT BLACK ..... | 831.50   |
| <b>CMB-2814N/C</b> | 28"x14" (22.8 LBS) #33 PURE WHITE OR #46 MIDNIGHT BLACK ..... | 916.50   |

POPLAR / KAPUR SHELLS

## COMPETITOR BASS DRUM & PEARL CARRIER PACKAGES

| PACKAGE #           | DRUM        | SIZE    | CARRIER | MSRP     |
|---------------------|-------------|---------|---------|----------|
| <b>CMB-1414/CXN</b> | CMB-1414N/C | 14"x14" | MXB-1   | \$809.00 |
| <b>CMB-1614/CXN</b> | CMB-1614N/C | 16"x14" | MXB-1   | 815.00   |
| <b>CMB-1814/CXN</b> | CMB-1814N/C | 18"x14" | MXB-1   | 871.50   |
| <b>CMB-2014/CXN</b> | CMB-2014N/C | 20"x14" | MXB-1   | 921.50   |
| <b>CMB-2214/CXN</b> | CMB-2214N/C | 22"x14" | MXB-1   | 995.50   |
| <b>CMB-2414/CXN</b> | CMB-2414N/C | 24"x14" | MXB-1   | 1,029.00 |
| <b>CMB-2614/CXN</b> | CMB-2614N/C | 26"x14" | MXB-1   | 1,063.00 |
| <b>CMB-2814/CXN</b> | CMB-2814N/C | 28"x14" | MXB-1   | 1,148.00 |

## TOMS

HEADS: CT

|                    |  |          |
|--------------------|--|----------|
| <b>CMT-8023N/C</b> | QUAD 8,10,12,13 (18.7 LBS) #33 OR #46 .....        | \$888.00 |
| <b>CMT-802N/C</b>  | TRIO 8,10,12 (12 LBS) #33 OR #46 .....             | 640.00   |
| <b>CMT-0808/C</b>  | 8"x8" #33 PURE WHITE OR #46 MIDNIGHT BLACK .....   | 210.50   |
| <b>CMT-1009/C</b>  | 10"x9" #33 PURE WHITE OR #46 MIDNIGHT BLACK .....  | 238.00   |
| <b>CMT-1210/C</b>  | 12"x10" #33 PURE WHITE OR #46 MIDNIGHT BLACK ..... | 272.00   |
| <b>CMT-1311/C</b>  | 13"x11" #33 PURE WHITE OR #46 MIDNIGHT BLACK ..... | 294.50   |

POPLAR / KAPUR SHELLS

## COMPETITOR QUAD / TRIO & PEARL CARRIER PACKAGES

| PACKAGE #           | DRUMS       | SIZES      | CARRIER | MSRP       |
|---------------------|-------------|------------|---------|------------|
| <b>CMT-8023/CXN</b> | CMT-8023N/C | 8-10-12-13 | MXT4-1  | \$1,221.00 |
| <b>CMT-802/CXN</b>  | CMT-802N/C  | 8-10-12    | MXT3-1  | 944.50     |

# PIPE BAND SERIES DRUMS

STANDARD HIGH GLOSS LACQUER FINISHES: • #109 ARCTIC WHITE • #110 SEQUOIA RED • #122 BLACK MIST • #126 EMERALD MIST  
 SPECIAL ORDER LACQUER FINISHES: PLEASE SEE PAGE 41 IN THIS PRICE LIST  
 SPECIAL ORDER POWDER COATING: • BLACK • WHITE • BLUE • YELLOW • RED • GREEN • ORANGE • PURPLE      PLEASE ALLOW 6-8 WEEKS FOR DELIVERY (IF DRUMS ARE IN STOCK).

## SNARE DRUMS

HEADS: REMO CYBERMAX BATTER & SA-0114 SNARE

### BIRCH

|   | POLISHED ALUMINUM | POWDER COATED | CHROME     |
|---|-------------------|---------------|------------|
| <b>FFXPMD-1412</b> 14"x12" MEDALIST w/LOWER WEIGHT (13.8 LBS) ..... | \$1,394.00        | \$1,676.00    | \$1,754.00 |

## BASS DRUMS

HEADS: REMO SMOOTH WHITE AMBASSADORS

### MAPLE

|   | POLISHED ALUMINUM | POWDER COATED | CHROME     |
|---|-------------------|---------------|------------|
| <b>BDP-2612</b> 26"x12" w/POLISHED ALUMINUM TUBE LUGS .....             | \$1,170.00        | \$1,366.00    | \$1,283.00 |
| <b>BDP-2812</b> 28"x12" w/POLISHED ALUMINUM TUBE LUGS (18.15 LBS) ..... | 1,292.00          | 1,488.50      | 1,404.00   |
| <b>BDP-2814</b> 28"x14" w/POLISHED ALUMINUM TUBE LUGS (19.45 LBS) ..... | 1,314.00          | 1,510.00      | 1,426.00   |
| <b>BDP-2816</b> 28"x16" w/POLISHED ALUMINUM TUBE LUGS .....             | 1,380.00          | 1,580.50      | 1,492.00   |
| <b>BDP-3016</b> 30"x16" w/POLISHED ALUMINUM TUBE LUGS .....             | 1,623.00          | 1,854.00      | 1,756.00   |
| <b>PB-2812N/C</b> 28"x12" W/3-PIECE LUGS (18.5 LBS) .....               | N/A               | N/A           | 1,242.00   |
| <b>PB-2814N/C</b> 28"x14" W/3-PIECE LUGS (20.5 LBS) .....               | N/A               | N/A           | 1,263.00   |
| <b>PB-2816N/C</b> 28"x16" W/3-PIECE LUGS (21.8 LBS) .....               | N/A               | N/A           | 1,306.00   |

## TENOR DRUMS

HEADS: REMO COATED AMBASSADORS

### MAPLE

|   | POLISHED ALUMINUM | POWDER COATED | CHROME   |
|---|-------------------|---------------|----------|
| <b>TDP-1412</b> 14"x12" w/WOOD HOOPS/ POLISHED ALUMINUM TUBE LUGS (8.5 LBS) ..... | \$773.00          | \$981.00      | \$886.00 |
| <b>TDP-1512</b> 15"x12" w/WOOD HOOPS/POLISHED ALUMINUM TUBE LUGS (8.8 LBS) .....  | 823.00            | 1,033.00      | 935.00   |
| <b>TDP-1612</b> 16"x12" w/WOOD HOOPS/POLISHED ALUMINUM TUBE LUGS (9.1 LBS) .....  | 845.00            | 1,050.50      | 957.00   |
| <b>TDP-1812</b> 18"x12" w/WOOD HOOPS/POLISHED ALUMINUM TUBE LUGS (10.6 LBS) ..... | 993.00            | 1,206.00      | 1,106.00 |
| <b>TDP-2012</b> 20"x12" w/WOOD HOOPS/POLISHED ALUMINUM TUBE LUGS .....            | 1,143.00          | 1,184.50      | 1,255.00 |
| <b>TDP-2014</b> 20"x14" w/WOOD HOOPS/POLISHED ALUMINUM TUBE LUGS .....            | 1,319.00          | 1,319.00      | 1,432.00 |
| <b>TDP-2212</b> 22"x12" w/WOOD HOOPS/POLISHED ALUMINUM TUBE LUGS .....            | 1,336.00          | 1,337.00      | 1,448.00 |
| <b>TDP-2214</b> 22"x14" w/WOOD HOOPS/POLISHED ALUMINUM TUBE LUGS .....            | 1,363.00          | 1,364.00      | 1,475.00 |

# ORCHESTRAL SNARE DRUMS

|                          |          |   |            |  |
|--------------------------|----------|---|------------|--|
| <b>NEW</b> PHP-1450/G400 | 14"x5"   | LIMITED EDITION PHILHARMONIC 6-PLY MAPLE GOLD HARDWARE w/PADDED BAG (JAN 2015)                                  | \$1,675.00 |  |
| <b>NEW</b> PHTRF-1450/C  | 14"x5"   | LIMITED EDITION PHILHARMONIC 20-PLY TAMO (2) MAPLE (12) BIRCH (6) w/PADDED BAG (GREY FADE OVER TAMO) (APR 2015) | 1,675.00   |  |
| <b>NEW</b> PHBG-1450/C   | 14"x5"   | LIMITED EDITION PHILHARMONIC 6-PLY BUBINGA (2) MAPLE (2) BUBINGA (2) w/PADDED BAG (JULY 2015)                   | 1,675.00   |  |
| <b>NEW</b> PHEP-1450/C   | 14"x5"   | LIMITED EDITION PHILHARMONIC VECTORCAST w/PADDED BAG (OCT 2015)   | 1,675.00   |  |
| PHM-1450                 | 14"x5"   | PHILHARMONIC SOLID MAPLE w/DIE CAST HOOPS, #103 PIANO BLACK* & #204 WALNUT BORDEAUX                             | 1,906.50   |  |
| PHM-1465                 | 14"x6.5" | PHILHARMONIC SOLID MAPLE w/DIE CAST HOOPS, #103 PIANO BLACK* & #204 WALNUT BORDEAUX                             | 1,917.00   |  |
| PHP-1340                 | 13"x4"   | PHILHARMONIC 6 PLY MAPLE w/SINGLE FLANGE HOOPS w/CLAW HOOKS, #103 PIANO BLACK & #101 WALNUT                     | 1,061.00   |  |
| PHP-1440                 | 14"x4"   | PHILHARMONIC 6 PLY MAPLE w/SINGLE FLANGE HOOPS w/CLAW HOOKS, #103 PIANO BLACK & #101 WALNUT                     | 1,153.50   |  |
| PHP-1450                 | 14"x5"   | PHILHARMONIC 6 PLY MAPLE w/DIE CAST HOOPS, #103 PIANO BLACK & #101 WALNUT                                       | 1,174.00   |  |
| PHP-1465                 | 14"x6.5" | PHILHARMONIC 6 PLY MAPLE w/DIE CAST HOOPS, #103 PIANO BLACK & #101 WALNUT                                       | 1,204.50   |  |
| PHP-1480                 | 14"x8"   | PHILHARMONIC 6 PLY MAPLE w/DIE CAST HOOPS, #103 PIANO BLACK & #101 WALNUT                                       | 1,409.50   |  |
| PHA-1440                 | 14"x4"   | PHILHARMONIC 3MM CAST ALUMINUM w/SINGLE FLANGE HOOPS w/CLAW HOOKS   | 1,184.00   |  |
| PHA-1450                 | 14"x5"   | PHILHARMONIC 3MM CAST ALUMINUM w/DIE CAST HOOPS   | 1,248.50   |  |
| PHA-1465                 | 14"x6.5" | PHILHARMONIC 3MM CAST ALUMINUM w/DIE CAST HOOPS   | 1,276.00   |  |
| PHF-1412                 | 14"x12"  | PHILHARMONIC 6 PLY MAPLE FIELD DRUM w/SUPERHOOP II, #103 PIANO BLACK* & #101 WALNUT                             | 1,435.00   |  |
| PHF-1616*                | 16"x16"  | PHILHARMONIC 6 PLY MAPLE FIELD DRUM w/SUPERHOOP II, #103 PIANO BLACK* & #101 WALNUT                             | 1,891.50   |  |
| PHB-1440                 | 14"x4"   | PHILHARMONIC BEADED BRASS w/SGL. FLANGE HOOPS/CLAW HOOKS, VINTAGE SNARE BEDS, BLACK NICKEL FINISH               | 1,238.00   |  |
| PHB-1450                 | 14"x5"   | PHILHARMONIC BEADED BRASS w/SGL. FLANGE HOOPS/CLAW HOOKS, VINTAGE SNARE BEDS, BLACK NICKEL FINISH               | 1,265.00   |  |
| PHB-1465                 | 14"x6.5" | PHILHARMONIC BEADED BRASS w/SGL. FLANGE HOOPS/CLAW HOOKS, VINTAGE SNARE BEDS, BLACK NICKEL FINISH               | 1,312.00   |  |
| PHB-1480                 | 14"x8"   | PHILHARMONIC BEADED BRASS w/SGL. FLANGE HOOPS/CLAW HOOKS, VINTAGE SNARE BEDS, BLACK NICKEL FINISH               | 1,532.50   |  |
| PHX-1450                 | 14"x5"   | PHILHARMONIC AFRICAN MAHOGANY, D/C HOOPS, VINTAGE SNARE BEDS, #210 MATTE WALNUT FINISH                          | 1,174.00   |  |
| PHX-1465                 | 14"x6.5" | PHILHARMONIC AFRICAN MAHOGANY, D/C HOOPS, VINTAGE SNARE BEDS, #210 MATTE WALNUT FINISH                          | 1,204.50   |  |
| PHX-1580                 | 15"x8"   | PHILHARMONIC AFRICAN MAHOGANY, MAPLE HOOPS, VINTAGE SNARE BEDS, #210 MATTE WALNUT FINISH                        | 1,195.00   |  |
| PHX-1616                 | 16"x16"  | PHILHARMONIC AFRICAN MAHOGANY, MAPLE HOOPS, VINTAGE SNARE BEDS, #210 MATTE WALNUT FINISH                        | 1,891.50   |  |
| SYP-1455                 | 14"x5.5" | SYMPHONIC 6 PLY MAPLE w/DIE CAST HOOPS, TUBE LUGS & STAINLESS STEEL TENSION RODS, #138 ANTIQUE SUNBURST         | 995.00     |  |
| SYP-1465                 | 14"x6.5" | SYMPHONIC 6 PLY MAPLE w/DIE CAST HOOPS, TUBE LUGS & STAINLESS STEEL TENSION RODS, #138 ANTIQUE SUNBURST         | 1,050.00   |  |
| CRP-1455                 | 14"x5.5" | CONCERT 6 PLY MAPLE w/SUPERHOOP II, TUBE LUGS, SR-017, RENAISSANCE BATTER, #102 NATURAL & #103 PIANO BLACK      | 765.00     |  |
| CRP-1465                 | 14"x6.5" | CONCERT 6 PLY MAPLE w/SUPERHOOP II, TUBE LUGS, SR-017, RENAISSANCE BATTER, #102 NATURAL & #103 PIANO BLACK      | 795.00     |  |

- \*SR-500 TRIAD SILENT STRAINER
- \*3 SNARE TYPES
- \*GRADUATED TENSION SNARES
- \*THUMBSCREW TENSION ADJUSTERS (3)
- \*VINTAGE-STYLE SNARE BEDS
- \*EXTREMELY WIDE DYNAMIC RANGE
- \*TUBE LUGS
- \*STAINLESS STEEL TENSION RODS
- \*REMO RENAISSANCE HEADS
- \*SPECIAL ORDER

- \*SR-300 TRIPLE THROW-OFF
- \*3 SNARE TYPES
- \*7 SNARE COMBINATIONS
- \*7 STRAND STAINLESS STEEL CABLE
- \*7 STRANDS THIN YELLOW CABLE
- \*ANGLE-MOUNTED SNARES

# ORCHESTRAL BASS DRUMS & TOMS

## PHILHARMONIC SERIES 6 PLY AFRICAN MAHOGANY #210 MATTE WALNUT LACQUER \*SPECIAL ORDER - EXTRA DELIVERY TIME REQUIRED

### BASS DRUMS

|            |                      |            |
|------------|----------------------|------------|
| PBA-2814   | 28"x14"              | \$2,034.50 |
| PBA-3216   | 32"x16"              | 2,529.50   |
| PBA-3616   | 36"x16"              | 2,882.00   |
| PBA-3618   | 36"x18"              | 2,909.50   |
| PBA-2814/S | 28"x14" w/STBD STAND | 3,264.50   |
| PBA-3216/S | 32"x16" w/STBD STAND | 3,759.50   |
| PBA-3616/S | 36"x16" w/STBD STAND | 4,112.00   |
| PBA-3618/S | 36"x18" w/STBD STAND | 4,139.50   |

### SYMPHONIC SERIES 6 PLY MAPLE #201 MATTE WALNUT LACQUER \*SPECIAL ORDER - EXTRA DELIVERY TIME REQUIRED

### BASS DRUMS

|             |                      |            |
|-------------|----------------------|------------|
| PBM-2814*   | 28"x14"              | \$1,804.00 |
| PBM-3216*   | 32"x16"              | 2,347.00   |
| PBM-3218*   | 32"x18"              | 2,374.50   |
| PBM-3616*   | 36"x16"              | 2,620.50   |
| PBM-3618    | 36"x18"              | 2,647.50   |
| PBM-3620    | 36"x20"              | 2,888.50   |
| PBM-3626    | 36"x26"              | 3,071.50   |
| PBM-2814/S* | 28"x14" w/STBD STAND | 3,034.00   |
| PBM-3216/S* | 32"x16" w/STBD STAND | 3,577.00   |
| PBM-3218/S* | 32"x18" w/STBD STAND | 3,604.50   |
| PBM-3616/S* | 36"x16" w/STBD STAND | 3,850.50   |
| PBM-3618/S  | 36"x18" w/STBD STAND | 3,877.50   |
| PBM-3620/S  | 36"x20" w/STBD STAND | 4,118.50   |
| PBM-3626/S  | 36"x26" w/STBD STAND | 4,301.50   |

### CONCERT SERIES #46 MIDNIGHT BLACK COVERING

### CONCERT BASS DRUMS w/6 PLY KAPUR SHELLS

|            |                                     |            |
|------------|-------------------------------------|------------|
| PBE-2814   | 28"x14"                             | \$1,288.00 |
| PBE-3216   | 32"x16"                             | 1,595.50   |
| PBE-3616   | 36"x16"                             | 1,784.50   |
| PBE-3618   | 36"x18"                             | 1,866.00   |
| PBE-2814/S | 28"x14" w/STBD STAND                | 2,518.00   |
| PBE-3216/S | 32"x16" w/STBD STAND                | 2,825.50   |
| PBE-3616/S | 36"x16" w/STBD STAND                | 3,014.50   |
| PBE-3616/F | 36"x16" w/STBD STAND & FIELD WHEELS | 3,037.50   |
| PBE-3618/S | 36"x18" w/STBD STAND                | 3,096.00   |
| PBE-3618/F | 36"x18" w/STBD STAND & FIELD WHEELS | 3,119.00   |

### SINGLE-HEADED CONCERT TOMS

|            |                |          |
|------------|----------------|----------|
| PTA-0608S* | 6"x8" w/BT-3   | \$447.50 |
| PTA-0808S* | 8"x8" w/BT-3   | 464.50   |
| PTA-1010S* | 10"x10" w/BT-3 | 509.50   |
| PTA-1210S* | 12"x10" w/BT-3 | 576.00   |
| PTA-1311S* | 13"x11" w/BT-3 | 638.00   |
| PTA-1412S* | 14"x12" w/BT-3 | 695.00   |
| PTA-1514S* | 15"x14" w/BT-3 | 772.00   |
| PTA-1614S* | 16"x14" w/BT-3 | 878.00   |

### SYMPHONIC SERIES 6 PLY MAPLE #201 MATTE WALNUT LACQUER \*SPECIAL ORDER - EXTRA DELIVERY TIME REQUIRED

### SINGLE-HEADED CONCERT TOMS

|            |                |          |
|------------|----------------|----------|
| PTM-0608S* | 6"x8" w/BT-3   | \$350.50 |
| PTM-0808S* | 8"x8" w/BT-3   | 350.50   |
| PTM-1010S* | 10"x10" w/BT-3 | 425.50   |
| PTM-1210S* | 12"x10" w/BT-3 | 468.50   |
| PTM-1311S* | 13"x11" w/BT-3 | 506.50   |
| PTM-1412S* | 14"x12" w/BT-3 | 576.00   |
| PTM-1514S* | 15"x14" w/BT-3 | 628.00   |
| PTM-1614S* | 16"x14" w/BT-3 | 700.00   |

### CONCERT TOM SETS POPLAR / KAPUR SHELLS - 6 PLY

|        |                                       |          |
|--------|---------------------------------------|----------|
| PTE-06 | 6"x8" POPLAR / KAPUR SHELLS - 6 PLY   | \$269.50 |
| PTE-08 | 8"x8" POPLAR / KAPUR SHELLS - 6 PLY   | 280.00   |
| PTE-10 | 10"x10" POPLAR / KAPUR SHELLS - 6 PLY | 291.00   |
| PTE-12 | 12"x10" POPLAR / KAPUR SHELLS - 6 PLY | 307.50   |
| PTE-13 | 13"x11" POPLAR / KAPUR SHELLS - 6 PLY | 318.00   |
| PTE-14 | 14"x12" POPLAR / KAPUR SHELLS - 6 PLY | 339.50   |
| PTE-15 | 15"x14" POPLAR / KAPUR SHELLS - 6 PLY | 377.00   |
| PTE-16 | 16"x14" POPLAR / KAPUR SHELLS - 6 PLY | 404.00   |

### DOUBLE-HEADED CONCERT TOMS

|            |                     |          |
|------------|---------------------|----------|
| PTA-0608D* | 6"x8" w/BT-3        | \$504.00 |
| PTA-0808D  | 8"x8" w/OPTIMOUNT   | 525.00   |
| PTA-1010D  | 10"x10" w/OPTIMOUNT | 572.50   |
| PTA-1210D  | 12"x10" w/OPTIMOUNT | 625.00   |
| PTA-1311D  | 13"x11" w/OPTIMOUNT | 730.00   |
| PTA-1412D  | 14"x12" w/OPTIMOUNT | 761.50   |
| PTA-1514D  | 15"x14" w/OPTIMOUNT | 882.00   |
| PTA-1614D  | 16"x14" w/OPTIMOUNT | 934.50   |

### SYMPHONIC SERIES 6 PLY MAPLE #201 MATTE WALNUT LACQUER \*SPECIAL ORDER - EXTRA DELIVERY TIME REQUIRED

### DOUBLE-HEADED CONCERT TOMS

|            |                     |          |
|------------|---------------------|----------|
| PTM-0608D* | 6"x8" w/BT-3        | \$460.00 |
| PTM-0808D  | 8"x8" w/OPTIMOUNT   | 514.00   |
| PTM-1010D  | 10"x10" w/OPTIMOUNT | 579.50   |
| PTM-1210D  | 12"x10" w/OPTIMOUNT | 627.50   |
| PTM-1311D  | 13"x11" w/OPTIMOUNT | 687.50   |
| PTM-1412D  | 14"x12" w/OPTIMOUNT | 752.00   |
| PTM-1514D  | 15"x14" w/OPTIMOUNT | 817.00   |
| PTM-1614D  | 16"x14" w/OPTIMOUNT | 892.50   |

### CONCERT TOM SETS POPLAR / KAPUR SHELLS - 6 PLY

|          |                               |          |
|----------|-------------------------------|----------|
| PTE-0608 | 6"x8"/8"x8" w/T-890 STAND     | \$720.00 |
| PTE-1012 | 10"x10"/12"x10" w/T-890 STAND | 786.50   |
| PTE-1314 | 13"x11"/14"x12" w/T-890 STAND | 845.00   |
| PTE-1516 | 15"x14"/16"x14" w/T-890 STAND | 995.00   |

# ORCHESTRAL STANDS

## CONCERT SNARE STANDS / CYMBAL STANDS / CONCERT TOM STANDS / TIMPANI THRONE





















|          |  |          |                     |                                   |          |          |   |          |
|----------|--|----------|---------------------|-----------------------------------|----------|----------|---|----------|
| S-1030LS | GYRO-LOCK SGL. BRACED LEGS 24.8"-31.89"  | \$219.00 | C-1000SC            | GOOSE NECK STAND SGL. BRACED LEGS | \$205.00 | D-3000TC | HYDRAULIC TIMPANI THRONE                | \$515.50 |
| S-1030L  | GYRO-LOCK DBL. BRACED LEGS 25.39"-32.48" | 269.00   | <b>NEW</b> C-1030SC | GOOSE NECK STAND SGL. BRACED LEGS | 205.00   | T-1030   | DBL TOM STAND 2xTH-1030S w/DBL BR. LEGS | 389.00   |
| S-700L   | GEAR SGL. BRACED LEGS 23.62"-33.46"      | 129.00   | <b>NEW</b> C-1030AC | CYMBAL CRADLE COMPLETE STAND      | 239.00   | T-930    | DBL TOM STAND 2xTH-900S w/DBL BR. LEGS  | 279.00   |
|          |  |          | <b>NEW</b> C-103AA  | CYMBAL CRADLE ONLY                | 169.00   |          |   |          |

### BASS DRUM STANDS

|         |  |          |          |  |            |        |  |        |
|---------|--|----------|----------|--|------------|--------|--|--------|
| CBS-15  | FOLDING STAND  | \$205.00 | STBD-28  | SUSPENDED STAND - 28"                    | \$1,230.00 | BD-014 | EYE HOOK FOR SUSPENDED BD STAND (1)    | \$7.00 |
| CBS-38C | TILTING STAND w/FOOTREST & CASTERS   | 540.00   | STBD-32  | SUSPENDED STAND - 32"                    | 1,230.00   | BD-015 | RUBBER BAND FOR SUSPENDED BD STAND (1) | 6.00   |
| CBS-80S | TILTING STAND - DIRECT DRUM MOUNT - 32"  | 980.00   | STBD-36  | SUSPENDED STAND - 36"                    | 1,230.00   | 250    | SET OF 19 BD-015 RUBBER BANDS          | 90.00  |
| CBS-80M | TILTING STAND - DIRECT DRUM MOUNT - 36"  | 980.00   | STBD-36F | SUSPENDED STAND - 36" w/IFL FRAME WHEELS | 1,253.00   |        |  |        |
| PMBDL3  | MULTI-FIT BASS DRUM LEGS SUSPENDS BASS DRUMS (3 EA)<br>HORIZONTALLY, HEIGHT/TILT ADJ. STANDING HEIGHT VERSION- NO DRILLING | 279.00   | STBD-40  | SUSPENDED STAND - 40"                    | 1,230.00   |        |  |        |
| PMBDL3C | MULTI-FIT BASS DRUM LEGS SUSPENDS BASS DRUMS (3 EA)<br>HORIZONTALLY, HEIGHT/TILT ADJ. SEATED HEIGHT VERSION- NO DRILLING   | 332.00   |          |  |            |        |  |        |





# ADAMS TIMPANI

## REVOLUTION

|   |                  |   |                   |
|---|------------------|---|-------------------|
|  | <b>RVFI20</b>    | 20" REVOLUTION FIBERGLASS BOWLS .....                   | <b>\$3,032.00</b> |
|  | <b>RVFI23</b>    | 23" REVOLUTION FIBERGLASS BOWLS .....                   | <b>3,032.00</b>   |
|  | <b>RVFI26</b>    | 26" REVOLUTION FIBERGLASS BOWLS .....                   | <b>3,092.00</b>   |
|  | <b>RVFI29</b>    | 29" REVOLUTION FIBERGLASS BOWLS .....                   | <b>3,166.00</b>   |
|  | <b>RVFI32</b>    | 32" REVOLUTION FIBERGLASS BOWLS .....                   | <b>3,392.00</b>   |
|  | <b>RVFI20FT*</b> | 20" REVOLUTION FIBERGLASS BOWLS w/FINE TUNER .....      | <b>3,280.00</b>   |
|  | <b>RVFI23FT*</b> | 23" REVOLUTION FIBERGLASS BOWLS w/FINE TUNER .....      | <b>3,280.00</b>   |
|  | <b>RVFI26FT*</b> | 26" REVOLUTION FIBERGLASS BOWLS w/FINE TUNER .....      | <b>3,342.00</b>   |
|  | <b>RVFI29FT*</b> | 29" REVOLUTION FIBERGLASS BOWLS w/FINE TUNER .....      | <b>3,414.00</b>   |
|  | <b>RVFI32FT*</b> | 32" REVOLUTION FIBERGLASS BOWLS w/FINE TUNER .....      | <b>3,642.00</b>   |
|  | <b>RVKG20FT</b>  | 20" REVOLUTION POLISHED COPPER BOWLS w/FINE TUNER ..... | <b>3,778.00</b>   |
|  | <b>RVKG23FT</b>  | 23" REVOLUTION POLISHED COPPER BOWLS w/FINE TUNER ..... | <b>3,778.00</b>   |
|  | <b>RVKG26FT</b>  | 26" REVOLUTION POLISHED COPPER BOWLS w/FINE TUNER ..... | <b>3,838.00</b>   |
|  | <b>RVKG29FT</b>  | 29" REVOLUTION POLISHED COPPER BOWLS w/FINE TUNER ..... | <b>3,914.00</b>   |
|  | <b>RVKG32FT</b>  | 32" REVOLUTION POLISHED COPPER BOWLS w/FINE TUNER ..... | <b>4,138.00</b>   |
|  | <b>RVKH20FT</b>  | 20" REVOLUTION HAMMERED COPPER BOWLS w/FINE TUNER ..    | <b>4,546.00</b>   |
|  | <b>RVKH23FT</b>  | 23" REVOLUTION HAMMERED COPPER BOWLS w/FINE TUNER ..    | <b>4,546.00</b>   |
|  | <b>RVKH26FT</b>  | 26" REVOLUTION HAMMERED COPPER BOWLS w/FINE TUNER ..    | <b>4,610.00</b>   |
|  | <b>RVKH29FT</b>  | 29" REVOLUTION HAMMERED COPPER BOWLS w/FINE TUNER ..    | <b>4,700.00</b>   |
|  | <b>RVKH32FT</b>  | 32" REVOLUTION HAMMERED COPPER BOWLS w/FINE TUNER ..    | <b>5,310.00</b>   |



\*SPECIAL ORDER: 4 TO 6 MONTHS DELIVERY TIME

## REVOLUTION TIMPANI PACKAGES

| PACKAGE #   | SIZES              | TYPE  | MSRP              |
|---|--------------------|---|-------------------|
|  | <b>RVFISET2</b>    | 26, 29 FIBERGLASS                               | <b>\$6,258.00</b> |
|  | <b>RVFISET4</b>    | 23, 26, 29, 32 FIBERGLASS                       | <b>12,682.00</b>  |
|  | <b>RVFISET5</b>    | 20, 23, 26, 29, 32 FIBERGLASS                   | <b>15,714.00</b>  |
|  | <b>RVFISET2FT*</b> | 26, 29 FIBERGLASS w/FINE TUNER                  | <b>6,756.00</b>   |
|  | <b>RVFISET4FT*</b> | 23, 26, 29, 32 FIBERGLASS w/FINE TUNER          | <b>13,678.00</b>  |
|  | <b>RVFISET5FT*</b> | 20, 23, 26, 29, 32 FIBERGLASS w/FINE TUNER      | <b>16,958.00</b>  |
|  | <b>RVKGSET2FT</b>  | 26, 29 POLISHED COPPER w/FINE TUNER             | <b>7,752.00</b>   |
|  | <b>RVKGSET4FT</b>  | 23, 26, 29, 32 POLISHED COPPER w/FINE TUNER     | <b>15,668.00</b>  |
|  | <b>RVKGSET5FT</b>  | 20, 23, 26, 29, 32 POLISHED COPPER w/FINE TUNER | <b>19,446.00</b>  |
|  | <b>RVKHSET2FT</b>  | 26, 29 HAMMERED COPPER w/FINE TUNER             | <b>9,310.00</b>   |
|  | <b>RVKHSET4FT</b>  | 23, 26, 29, 32 HAMMERED COPPER w/FINE TUNER     | <b>19,166.00</b>  |
|  | <b>RVKHSET5FT</b>  | 20, 23, 26, 29, 32 HAMMERED COPPER w/FINE TUNER | <b>23,712.00</b>  |

- \* PATENTED FOLDING BASE & BOWL COME APART WITHOUT TOOLS
- \* RENAISSANCE TIMPANI HEADS WITH ALUMINUM INSERT RINGS
- \* PATENTED WIDE-RANGE HAND FINE TUNER
- \* PATENTED BALANCED-ACTION PEDAL SYSTEM
- \* PATENTED HEIGHT ADJUSTMENT SYSTEM
- \* PATENTED TENSION MECHANISM
- \* SHORT COVERS, MUTES & TUNING KEY INCLUDED
- \* FIXED THIRD WHEEL w/BRAKE
- \* DOUBLE-LOCKING WHEELS
- \* TUNING GAUGE

























## BAROQUE TIMPANI

|   |                |                                 |                   |
|---|----------------|---------------------------------|-------------------|
|  | <b>BPKH23*</b> | 23" HAMMERED COPPER BOWLS ..... | <b>\$4,546.00</b> |
|  | <b>BPKH26*</b> | 26" HAMMERED COPPER BOWLS ..... | <b>4,780.00</b>   |















\*SPECIAL ORDER: 4 TO 6 MONTHS DELIVERY TIME

- \* HAMMERED COPPER BOWLS
- \* FINE THREAD TUNING SCREW
- \* KALFO CALFSKIN HEADS
- \* STAND INCLUDED

## PROFESSIONAL GENERATION II

|   |                 |  |                   |
|---|-----------------|--|-------------------|
|    | <b>P2FI20</b>   | 20" GEN II FIBERGLASS .....                            | <b>\$3,390.00</b> |
|   | <b>P2FI23</b>   | 23" GEN II FIBERGLASS .....                            | <b>3,390.00</b>   |
|  | <b>P2FI26</b>   | 26" GEN II FIBERGLASS .....                            | <b>3,436.00</b>   |
|  | <b>P2FI29</b>   | 29" GEN II FIBERGLASS .....                            | <b>3,626.00</b>   |
|  | <b>P2FI32</b>   | 32" GEN II FIBERGLASS .....                            | <b>3,742.00</b>   |
|  | <b>P2KG20</b>   | 20" GEN II POLISHED COPPER .....                       | <b>4,424.00</b>   |
|  | <b>P2KG23</b>   | 23" GEN II POLISHED COPPER .....                       | <b>4,656.00</b>   |
|  | <b>P2KG26</b>   | 26" GEN II POLISHED COPPER .....                       | <b>4,724.00</b>   |
|  | <b>P2KG29</b>   | 29" GEN II POLISHED COPPER .....                       | <b>5,216.00</b>   |
|  | <b>P2KG32</b>   | 32" GEN II POLISHED COPPER .....                       | <b>5,358.00</b>   |
|  | <b>P2KH20</b>   | 20" GEN II HAMMERED COPPER .....                       | <b>4,692.00</b>   |
|  | <b>P2KH23</b>   | 23" GEN II HAMMERED COPPER .....                       | <b>4,826.00</b>   |
|  | <b>P2KH26</b>   | 26" GEN II HAMMERED COPPER .....                       | <b>5,080.00</b>   |
|  | <b>P2KH29</b>   | 29" GEN II HAMMERED COPPER .....                       | <b>5,530.00</b>   |
|  | <b>P2KH32</b>   | 32" GEN II HAMMERED COPPER .....                       | <b>5,808.00</b>   |
|  | <b>P2DH20*</b>  | 20" GEN II HAMMERED CAMBERED COPPER .....              | <b>5,912.00</b>   |
|  | <b>P2DH23*</b>  | 23" GEN II HAMMERED CAMBERED COPPER .....              | <b>5,978.00</b>   |
|  | <b>P2DH26*</b>  | 26" GEN II HAMMERED CAMBERED COPPER .....              | <b>6,056.00</b>   |
|  | <b>P2DH29*</b>  | 29" GEN II HAMMERED CAMBERED COPPER .....              | <b>6,270.00</b>   |
|  | <b>P2DH32*</b>  | 32" GEN II HAMMERED CAMBERED COPPER .....              | <b>6,940.00</b>   |
|  | <b>P2DH20FT</b> | 20" GEN II HAMMERED CAMBERED COPPER w/FINE TUNER ..... | <b>6,198.00</b>   |
|  | <b>P2DH23FT</b> | 23" GEN II HAMMERED CAMBERED COPPER w/FINE TUNER ..... | <b>6,264.00</b>   |
|  | <b>P2DH26FT</b> | 26" GEN II HAMMERED CAMBERED COPPER w/FINE TUNER ..... | <b>6,342.00</b>   |
|  | <b>P2DH29FT</b> | 29" GEN II HAMMERED CAMBERED COPPER w/FINE TUNER ..... | <b>6,556.00</b>   |
|  | <b>P2DH32FT</b> | 32" GEN II HAMMERED CAMBERED COPPER w/FINE TUNER ..... | <b>7,226.00</b>   |

## GENERATION II TIMPANI PACKAGES

| PACKAGE #   | SIZES             | TYPE   | MSRP              |
|---|-------------------|--|-------------------|
|  | <b>P2FISET2</b>   | 26, 29 FIBERGLASS  | <b>\$7,062.00</b> |
|  | <b>P2FISET4</b>   | 23, 26, 29, 32 FIBERGLASS                                | <b>14,194.00</b>  |
|  | <b>P2FISET5</b>   | 20, 23, 26, 29, 32 FIBERGLASS                            | <b>17,584.00</b>  |
|  | <b>P2KGSET2</b>   | 26, 29 SMOOTH COPPER                                     | <b>9,940.00</b>   |
|  | <b>P2KGSET4</b>   | 23, 26, 29, 32 SMOOTH COPPER                             | <b>19,954.00</b>  |
|  | <b>P2KGSET5</b>   | 20, 23, 26, 29, 32 SMOOTH COPPER                         | <b>24,378.00</b>  |
|  | <b>P2KHSET2</b>   | 26, 29 HAMMERED COPPER                                   | <b>10,610.00</b>  |
|  | <b>P2KHSET4</b>   | 23, 26, 29, 32 HAMMERED COPPER                           | <b>21,244.00</b>  |
|  | <b>P2KHSET5</b>   | 20, 23, 26, 29, 32 HAMMERED COPPER                       | <b>25,936.00</b>  |
|  | <b>P2DHSET2*</b>  | 26, 29 HAMMERED CAMBERED COPPER                          | <b>12,326.00</b>  |
|  | <b>P2DHSET4*</b>  | 23, 26, 29, 32 HAMMERED CAMBERED COPPER                  | <b>25,244.00</b>  |
|  | <b>P2DHSET5*</b>  | 20, 23, 26, 29, 32 HAMMERED CAMBERED COPPER              | <b>31,156.00</b>  |
|  | <b>P2DHSET2FT</b> | 26, 29 HAMMERED CAMBERED COPPER w/FINE TUNER             | <b>12,898.00</b>  |
|  | <b>P2DHSET4FT</b> | 23, 26, 29, 32 HAMMERED CAMBERED COPPER w/FINE TUNER     | <b>26,388.00</b>  |
|  | <b>P2DHSET5FT</b> | 20, 23, 26, 29, 32 HAMMERED CAMBERED COPPER w/FINE TUNER | <b>32,586.00</b>  |











## GENERATION II ENDURANCE FIELD WHEELS

**PR302F WHEEL SET FOR 1 DRUM ..... \$704.00**

- \* SINGLE-FLANGE CHROME SUSPENSION RING FOR MAXIMUM PROJECTION
- \* RENAISSANCE TIMPANI HEADS WITH INSERT RINGS
- \* SUSPENDED BOWL FOR TONAL CLARITY
- \* SHORT COVERS, MUTES AND TUNING KEY INCLUDED
- \* PATENTED BALANCED SPRING PEDAL SYSTEM
- \* DOUBLE-LOCKING WHEELS
- \* TUNING GAUGE
- \* FIXED 3RD WHEEL w/BRAKE

## SYMPHONIC

EUROPEAN TOE-BLOCK PEDAL  
WRATCHET FREE LEG OPERATED DESIGN

|   |                |  |                   |
|---|----------------|--|-------------------|
|  | <b>SYKH20*</b> | 20" SYMPHONIC HAMMERED COPPER .....          | <b>\$6,844.00</b> |
|  | <b>SYKH23*</b> | 23" SYMPHONIC HAMMERED COPPER .....          | <b>6,912.00</b>   |
|  | <b>SYKH26*</b> | 26" SYMPHONIC HAMMERED COPPER .....          | <b>6,988.00</b>   |
|  | <b>SYKH29*</b> | 29" SYMPHONIC HAMMERED COPPER .....          | <b>7,114.00</b>   |
|  | <b>SYKH32*</b> | 32" SYMPHONIC HAMMERED COPPER .....          | <b>7,896.00</b>   |
| *SPECIAL ORDER: 4 TO 6 MONTHS DELIVERY TIME                                       |                |  |                   |
|  | <b>SYDH20*</b> | 20" SYMPHONIC HAMMERED CAMBERED COPPER ..... | <b>\$8,820.00</b> |
|  | <b>SYDH23*</b> | 23" SYMPHONIC HAMMERED CAMBERED COPPER ..... | <b>8,884.00</b>   |
|  | <b>SYDH26*</b> | 26" SYMPHONIC HAMMERED CAMBERED COPPER ..... | <b>8,954.00</b>   |
|  | <b>SYDH29*</b> | 29" SYMPHONIC HAMMERED CAMBERED COPPER ..... | <b>9,380.00</b>   |
|  | <b>SYDH32*</b> | 32" SYMPHONIC HAMMERED CAMBERED COPPER ..... | <b>10,154.00</b>  |

\*SPECIAL ORDER: 4 TO 6 MONTHS DELIVERY TIME

- \* HAMMERED COPPER BOWLS FOR CLEAR, PURE TONE
- \* RENAISSANCE TIMPANI HEADS w/INSERT RINGS
- \* SUSPENSION RING MAINTAINS KETTLE ROUNDNESS, ENSURES STABILITY DURING TRANSPORT
- \* LINEAR-FEEL PEDAL ACTION
- \* THREE WHEELS w/BRAKES
- \* FINE TUNER
- \* TUNING GAUGE
- \* COVERS INCLUDED



# PHILHARMONIC LIGHT

DRESDEN-STYLE PEDAL  
W/INFINITELY ADJUSTABLE CLUTCH FORMERLY KNOWN AS THE  
CLOYD DUFF DRESDEN SERIES

|          |                                       |             |
|----------|---------------------------------------|-------------|
| PLCD20   | 20" DRESDEN-STYLE w/RENAISSANCE HEADS | \$13,102.00 |
| PLCD23   | 23" DRESDEN-STYLE w/RENAISSANCE HEADS | 13,102.00   |
| PLCD25*  | 25" DRESDEN-STYLE w/RENAISSANCE HEADS | 13,240.00   |
| PLCD26   | 26" DRESDEN-STYLE w/RENAISSANCE HEADS | 13,378.00   |
| PLCD28*  | 28" DRESDEN-STYLE w/RENAISSANCE HEADS | 13,662.00   |
| PLCD29   | 29" DRESDEN-STYLE w/RENAISSANCE HEADS | 14,010.00   |
| PLCD30*  | 30" DRESDEN-STYLE w/RENAISSANCE HEADS | 14,298.00   |
| PLCD32   | 32" DRESDEN-STYLE w/RENAISSANCE HEADS | 14,564.00   |
| PLCD20C* | 20" DRESDEN-STYLE w/CALF HEADS        | 14,298.00   |
| PLCD23C* | 23" DRESDEN-STYLE w/CALF HEADS        | 14,428.00   |
| PLCD25C* | 25" DRESDEN-STYLE w/CALF HEADS        | 14,354.00   |
| PLCD26C* | 26" DRESDEN-STYLE w/CALF HEADS        | 14,706.00   |
| PLCD28C* | 28" DRESDEN-STYLE w/CALF HEADS        | 14,994.00   |
| PLCD29C* | 29" DRESDEN-STYLE w/CALF HEADS        | 15,266.00   |
| PLCD30C* | 30" DRESDEN-STYLE w/CALF HEADS        | 15,546.00   |
| PLCD32C* | 32" DRESDEN-STYLE w/CALF HEADS        | 15,822.00   |

NOTE: GERMAN-STYLE AVAILABLE ON REQUEST. BERLIN PEDAL AVAILABLE ON REQUEST.  
\*SPECIAL ORDER: 4 TO 6 MONTHS DELIVERY TIME

## PHILHARMONIC LIGHT TIMPANI PACKAGES

| PACKAGE # | SIZES              | TYPE     | MSRP        |
|-----------|--------------------|----------|-------------|
| PLCDSET2  | 26, 29             | AMERICAN | \$27,388.00 |
| PLCDSET4  | 23, 26, 29, 32     | AMERICAN | 55,054.00   |
| PLCDSET5  | 20, 23, 26, 29, 32 | AMERICAN | 68,156.00   |

- PATENTED SPLIT ROCKER ARM FOR SUPER-SMOOTH & SILENT PEDAL ACTION
- CHROME PLATED COUNTERHOOPS, TENSION RODS & CENTERING DEVICES
- COPPER HAMMERED CAMBERED BOWLS
- EXTREMELY ACCURATE TUNING GAUGES
- ADJUSTABLE PEDAL PRESSURE
- ADJUSTABLE TILTING MECHANISM
- COVERS & MUTES INCLUDED
- CASTERS w/BRAKES
- FINE TUNER

# PHILHARMONIC "DRESDEN CLASSIC"

DRESDEN-STYLE PEDAL  
W/RATCHET CLUTCH

|            |   |             |
|------------|---|-------------|
| PHDCW20L   | 20" w/WHEELS (AMERICAN SET-UP)              | \$13,102.00 |
| PHDCW23L   | 23" w/WHEELS (AMERICAN SET-UP)              | 13,102.00   |
| PHDCW26L   | 26" w/WHEELS (AMERICAN SET-UP)              | 13,378.00   |
| PHDCW29L   | 29" w/WHEELS (AMERICAN SET-UP)              | 14,010.00   |
| PHDCW32L   | 32" w/WHEELS (AMERICAN SET-UP)              | 14,564.00   |
| PHDC20*    | 20" (AMERICAN SET-UP)                       | 13,102.00   |
| PHDC23*    | 23" (AMERICAN SET-UP)                       | 13,102.00   |
| PHDC26*    | 26" (AMERICAN SET-UP)                       | 13,378.00   |
| PHDC29*    | 29" (AMERICAN SET-UP)                       | 14,010.00   |
| PHDC32*    | 32" (AMERICAN SET-UP)                       | 14,564.00   |
| PHDCW20LC* | 20" w/WHEELS & CALF HEADS (AMERICAN SET-UP) | 14,298.00   |
| PHDCW23LC* | 23" w/WHEELS & CALF HEADS (AMERICAN SET-UP) | 14,428.00   |
| PHDCW26LC* | 26" w/WHEELS & CALF HEADS (AMERICAN SET-UP) | 14,706.00   |
| PHDCW29LC* | 29" w/WHEELS & CALF HEADS (AMERICAN SET-UP) | 15,266.00   |
| PHDCW32LC* | 32" w/WHEELS & CALF HEADS (AMERICAN SET-UP) | 15,822.00   |

NOTE: GERMAN-STYLE AVAILABLE ON REQUEST. BERLIN PEDAL AVAILABLE ON REQUEST.  
\*SPECIAL ORDERS: 4 TO 6 MONTHS DELIVERY TIME

## PHILHARMONIC "DRESDEN CLASSIC" TIMPANI PACKAGES

| PACKAGE #  | SIZES                       | TYPE     | MSRP        |
|------------|-----------------------------|----------|-------------|
| PHDCWSET2L | 26, 29 w/WHEELS             | AMERICAN | \$27,388.00 |
| PHDCWSET4L | 23, 26, 29, 32 w/WHEELS     | AMERICAN | 55,054.00   |
| PHDCWSET5L | 20, 23, 26, 29, 32 w/WHEELS | AMERICAN | 68,156.00   |

- NICKEL-PLATED COUNTER HOOPS, TENSION RODS & CENTERING DEVICES
- SPLIT ROCKER ARM FOR SUPER-SMOOTH SILENT PEDAL ACTION
- RENAISSANCE TIMPANI HEADS w/INSERT RINGS
- EXTREMELY ACCURATE TUNING GAUGES
- PURE AND QUICK RESPONSE WITH A WIDE COLOR RANGE
- SPECIAL DESIGN STRONG CAST STEEL STRUTS
- COPPER HAMMERED CAMBERED BOWLS
- COVERS & MUTES INCLUDED

# SCHNELLAR

DRESDEN-STYLE PEDAL  
SCHNELLAR BOWL-ACTIVATED TUNING SYSTEM

|           |  |             |
|-----------|--|-------------|
| PLSD20L*  | 20" DRESDEN PEDAL w/CALF HEADS & ROAD CASE - AMERICAN    | \$17,516.00 |
| PLSD23L*  | 23" DRESDEN PEDAL w/CALF HEADS & ROAD CASE - AMERICAN    | 18,068.00   |
| PLSD25L*  | 25" DRESDEN PEDAL w/CALF HEADS & ROAD CASE - AMERICAN    | 18,068.00   |
| PLSD26L*  | 26" DRESDEN PEDAL w/CALF HEADS & ROAD CASE - AMERICAN    | 18,610.00   |
| PLSD28L*  | 28" DRESDEN PEDAL w/CALF HEADS & ROAD CASE - AMERICAN    | 18,610.00   |
| PLSD29L*  | 29" DRESDEN PEDAL w/CALF HEADS & ROAD CASE - AMERICAN    | 19,162.00   |
| PLSD32L*  | 32" DRESDEN PEDAL w/CALF HEADS & ROAD CASE - AMERICAN    | 19,704.00   |
| PLSD20LP* | 20" DRESDEN PEDAL w/PLASTIC HEADS & ROAD CASE - AMERICAN | 17,516.00   |
| PLSD23LP* | 23" DRESDEN PEDAL w/PLASTIC HEADS & ROAD CASE - AMERICAN | 18,068.00   |
| PLSD25LP* | 25" DRESDEN PEDAL w/PLASTIC HEADS & ROAD CASE - AMERICAN | 18,068.00   |
| PLSD26LP* | 26" DRESDEN PEDAL w/PLASTIC HEADS & ROAD CASE - AMERICAN | 18,610.00   |
| PLSD28LP* | 28" DRESDEN PEDAL w/PLASTIC HEADS & ROAD CASE - AMERICAN | 18,610.00   |
| PLSD29LP* | 29" DRESDEN PEDAL w/PLASTIC HEADS & ROAD CASE - AMERICAN | 19,162.00   |
| PLSD32LP* | 32" DRESDEN PEDAL w/PLASTIC HEADS & ROAD CASE - AMERICAN | 19,704.00   |

NOTE: GERMAN-STYLE AVAILABLE ON REQUEST  
\*SPECIAL ORDER: 4 TO 6 MONTHS DELIVERY TIME

|          |   |             |
|----------|---|-------------|
| PLSD20K* | 20" KURBEL (CRANK) w/CALF HEADS & ROAD CASE | \$16,202.00 |
| PLSD23K* | 23" KURBEL (CRANK) w/CALF HEADS & ROAD CASE | 16,754.00   |
| PLSD25K* | 25" KURBEL (CRANK) w/CALF HEADS & ROAD CASE | 16,754.00   |
| PLSD26K* | 26" KURBEL (CRANK) w/CALF HEADS & ROAD CASE | 17,296.00   |
| PLSD28K* | 28" KURBEL (CRANK) w/CALF HEADS & ROAD CASE | 17,296.00   |
| PLSD29K* | 29" KURBEL (CRANK) w/CALF HEADS & ROAD CASE | 17,848.00   |
| PLSD32K* | 32" KURBEL (CRANK) w/CALF HEADS & ROAD CASE | 18,390.00   |

NOTE: GERMAN-STYLE AVAILABLE ON REQUEST  
\*SPECIAL ORDER: 4 TO 6 MONTHS DELIVERY TIME

- KALFO CALF HEADS w/RECTANGULAR FLESH HOOPS FOR CLAW TENSION RODS
- COPPER HAMMERED POINTED BOWLS
- BOWL ACTIVATED TUNING SYSTEM
- THREE-LEG BASE SYSTEM
- NICKEL PLATED METAL PARTS
- COVERS & MUTES INCLUDED

# TIMPANI KEY / MUFFLER

|        |                            |         |
|--------|----------------------------|---------|
| PBA-02 | ADAMS TIMPANI MUTE MUFFLER | \$24.00 |
| PM-100 | ADAMS TIMPANI KEY          | 67.50   |

# TIMPANI BAGS & COVERS

|          |                           |         |        |                                |          |          |                                   |          |
|----------|---------------------------|---------|--------|--------------------------------|----------|----------|-----------------------------------|----------|
| TPCV-20  | 20" TIMPANI COVER - SHORT | \$82.00 | TPRV20 | 20" REVOLUTION BOWL BAG        | \$340.00 | TRAPPH20 | WOOD HEAD COVER FOR 20" PHIL TIMP | \$236.00 |
| TPCV-23  | 23" TIMPANI COVER - SHORT | 82.00   | TPRV23 | 23" REVOLUTION BOWL BAG        | 340.00   | TRAPPH21 | WOOD HEAD COVER FOR 21" PHIL TIMP | 236.00   |
| TPCV-25  | 25" TIMPANI COVER - SHORT | 82.00   | TPRV26 | 26" REVOLUTION BOWL BAG        | 340.00   | TRAPPH23 | WOOD HEAD COVER FOR 23" PHIL TIMP | 236.00   |
| TPCV-26  | 26" TIMPANI COVER - SHORT | 82.00   | TPRV29 | 29" REVOLUTION BOWL BAG        | 340.00   | TRAPPH25 | WOOD HEAD COVER FOR 25" PHIL TIMP | 236.00   |
| TPCV-28  | 28" TIMPANI COVER - SHORT | 82.00   | TPRV32 | 32" REVOLUTION BOWL BAG        | 340.00   | TRAPPH26 | WOOD HEAD COVER FOR 26" PHIL TIMP | 236.00   |
| TPCV-29  | 29" TIMPANI COVER - SHORT | 82.00   | TPRVB  | BAG FOR BASE w/HANDLE & WHEELS | 372.00   | TRAPPH28 | WOOD HEAD COVER FOR 28" PHIL TIMP | 236.00   |
| TPCV-30  | 30" TIMPANI COVER - SHORT | 82.00   |        |                                |          | TRAPPH29 | WOOD HEAD COVER FOR 29" PHIL TIMP | 236.00   |
| TPCV-32  | 32" TIMPANI COVER - SHORT | 82.00   |        |                                |          | TRAPPH30 | WOOD HEAD COVER FOR 30" PHIL TIMP | 236.00   |
| TPCV-20L | 20" TIMPANI COVER - LONG  | 128.00  |        |                                |          | TRAPPH32 | WOOD HEAD COVER FOR 32" PHIL TIMP | 236.00   |
| TPCV-23L | 23" TIMPANI COVER - LONG  | 128.00  |        |                                |          |          |                                   |          |
| TPCV-25L | 25" TIMPANI COVER - LONG  | 128.00  |        |                                |          |          |                                   |          |
| TPCV-26L | 26" TIMPANI COVER - LONG  | 128.00  |        |                                |          |          |                                   |          |
| TPCV-28L | 28" TIMPANI COVER - LONG  | 128.00  |        |                                |          |          |                                   |          |
| TPCV-29L | 29" TIMPANI COVER - LONG  | 128.00  |        |                                |          |          |                                   |          |
| TPCV-30L | 30" TIMPANI COVER - LONG  | 128.00  |        |                                |          |          |                                   |          |
| TPCV-32L | 32" TIMPANI COVER - LONG  | 128.00  |        |                                |          |          |                                   |          |

# ADAMS MALLET INSTRUMENTS

## MARIMBAS

|  |   |            |   |
|--|---|------------|---|
|  | <b>AMPD-30</b> ACADEMY 3.0 OCTAVE PADOUK w/X-STYLE STAND .....                                  | \$1,995.00 | * CAN BE USED ON A TABLE TOP OR WITH THE INCLUDED HEIGHT-ADJUSTABLE X-STYLE STAND<br>* INTEGRATED RESONATOR/RAIL SYSTEM * COVER & MALLETS INCLUDED  |
|  | <b>AMPD-33R</b> ACADEMY 3.3 OCTAVE PADOUK w/RESONATORS & X-STYLE STAND .....                    | 2,495.00   |   |
|  | <b>MSHV-43</b> SOLOIST 4.3 OCTAVE ROSEWOOD w/VOYAGER FRAME - BARS: 2.3"-1.6" .....              | 9,126.00   | * A=442 HZ TUNED THROUGH THE SIXTH OVERTONE<br>* GRADUATED NARROW BAR CONFIGURATION<br>* GOLD POWDER COATED ESSENTIAL TUBE RESONATORS<br>* HEIGHT-ADJUSTABLE VOYAGER FRAME<br>* COVER & MALLETS INCL  |
|  | <b>MSPV-43</b> SOLOIST 4.3 OCTAVE PADOUK w/VOYAGER FRAME, BARS: 2.3"-1.6" .....                 | 5,272.00   |   |
|  | <b>MSPVJ-30</b> SOLOIST 3.0 OCTAVE PADOUK w/VOYAGER FRAME, BARS: 2.2"-1.6" .....                | 3,416.00   |   |
|  | <b>MCHV-43</b> CONCERT SERIES 4.3 OCTAVE ROSEWOOD w/VOYAGER FRAME .....                         | 10,418.00  | * A=442 HZ TUNED THROUGH THE SIXTH OVERTONE<br>* GRADUATED WIDE BAR CONFIGURATION 2.6"-1.6"<br>* HEIGHT-ADJUSTABLE VOYAGER OR ENDURANCE FIELD FRAME<br>* GOLD POWDER COATED ESSENTIAL TUBE RESONATORS<br>* COVER & MALLETS INCLUDED   |
|  | <b>MCKF-43</b> CONCERT SERIES 4.3 OCTAVE SYNTHETIC w/ENDURANCE FIELD FRAME .....                | 7,560.00   |   |
|  | <b>MCKV-43</b> CONCERT SERIES 4.3 OCTAVE SYNTHETIC w/VOYAGER FRAME .....                        | 6,904.00   |   |
|  | <b>MCPV-43</b> CONCERT SERIES 4.3 OCTAVE PADOUK w/VOYAGER FRAME .....                           | 5,476.00   |   |
|  | <b>MCRWS-43</b> SET ROSEWOOD BARS FOR CONCERT 4.3 MARIMBAS .....                                | 6,653.00   |   |
|  | <b>MCSYS-43</b> SET SYNTHETIC BARS FOR CONCERT 4.3 MARIMBAS .....                               | 6,653.00   |   |
|  | <b>MCPDS-43</b> SET PADOUK BARS FOR CONCERT 4.3 MARIMBAS .....                                  | 4,066.00   |   |
|  | <b>MAHV-50*</b> ARTIST SERIES 5.0 OCTAVE ARTIST ROSEWOOD BARS w/VOYAGER FRAME .....             | 20,596.00  | * HONDURAS ROSEWOOD BARS 2.75"-1.6"<br>* A=442 HZ TUNED THROUGH THE SIXTH OVERTONE<br>* HEIGHT-ADJUSTABLE VOYAGER OR ENDURANCE FIELD FRAME<br>* GREY POWDERCOAT ARTIST TUNABLE RESONATORS<br>* HEIGHT-ADJUSTABLE VOYAGER OR ENDURANCE FIELD FRAME<br>* COVER & MALLETS INCLUDED |
|  | <b>MAHF-50*</b> ARTIST SERIES 5.0 OCTAVE ARTIST ROSEWOOD BARS w/ENDURANCE FIELD FRAME .....     | 22,368.00  |   |
|  | <b>MAKF-50</b> ARTIST SERIES 5.0 OCTAVE ARTIST SYNTHETIC BARS w/ENDURANCE FIELD FRAME .....     | 20,596.00  |   |
|  | <b>MAHV-46*</b> ARTIST SERIES 4.6 OCTAVE ARTIST ROSEWOOD BARS w/VOYAGER FRAME .....             | 15,590.00  |   |
|  | <b>MAHF-46*</b> ARTIST SERIES 4.6 OCTAVE ARTIST ROSEWOOD BARS w/ENDURANCE FIELD FRAME .....     | 19,776.00  |   |
|  | <b>MAKF-46</b> ARTIST SERIES 4.6 OCTAVE ARTIST SYNTHETIC BARS w/ENDURANCE FIELD FRAME .....     | 17,322.00  |   |
|  | <b>MAHV-43*</b> ARTIST SERIES 4.3 OCTAVE ARTIST ROSEWOOD BARS w/VOYAGER FRAME .....             | 11,414.00  |   |
|  | <b>MAHF-43*</b> ARTIST SERIES 4.3 OCTAVE ARTIST ROSEWOOD BARS w/ENDURANCE FIELD FRAME .....     | 14,626.00  |   |
|  | <b>MAKF-43</b> ARTIST SERIES 4.3 OCTAVE ARTIST SYNTHETIC BARS w/ENDURANCE FIELD FRAME .....     | 13,922.00  |   |
|  | <b>MAHR-AC*</b> ARTIST SERIES "A TO C" CONVERSION KIT .....                                     | 10,272.00  |   |
|  | <b>MAHR-CA*</b> ARTIST SERIES "C TO A" CONVERSION KIT .....                                     | 1,456.00   | * SPECIAL ORDER   |
|  | <b>MAHC-55*</b> ARTIST CLASSIC 5.5 OCTAVE C2-G7 ROSEWOOD BARS w/VOYAGER FRAME .....             | 23,202.00  | * HONDURAS ROSEWOOD BARS 2.75"-1.6"<br>* A=442 HZ TUNED THROUGH THE SIXTH OVERTONE<br>* ARTIST TUNABLE RESONATORS - BLACK POWDERCOAT<br>* HEIGHT-ADJUSTABLE VOYAGER OR ENDURANCE FIELD FRAME<br>* COVER & MALLETS INCLUDED  |
|  | <b>MAHC-50*</b> ARTIST CLASSIC 5.0 OCTAVE ROSEWOOD BARS w/VOYAGER FRAME .....                   | 20,596.00  |   |
|  | <b>MAHC-43*</b> ARTIST CLASSIC 4.3 OCTAVE ROSEWOOD BARS w/VOYAGER FRAME .....                   | 11,414.00  |   |
|  | <b>MAHC-AC*</b> ARTIST CLASSIC "A TO C" CONVERSION KIT .....                                    | 10,272.00  |   |
|  | <b>MAHC-CA*</b> ARTIST CLASSIC "C TO A" CONVERSION KIT .....                                    | 1,456.00   | * SPECIAL ORDER   |
|  | <b>MACC-50</b> ARTIST CLASSIC CUSTOM 5.0 OCTAVE w/VOYAGER FRAME .....                           | 23,620.00  | * HONDURAS ROSEWOOD BARS 2.75"-1.6"<br>* A=442 HZ TUNED THROUGH THE SIXTH OVERTONE<br>* DESERT POWDERCOAT ARTIST TUNABLE RESONATORS<br>* HEIGHT-ADJUSTABLE OAK VOYAGER FRAME<br>* COVER & MALLETS INCLUDED  |
|  | <b>MACC-43</b> ARTIST CLASSIC CUSTOM 4.3 OCTAVE w/VOYAGER FRAME .....                           | 12,254.00  |   |
|  | <b>MAHA43</b> ALPHA SERIES 4.3 OCTAVE ROSEWOOD MARIMBA (PLEASE SPECIFY ALPHA FINISH CODE) ..... | 11,414.00  |   |
|  | <b>MAHA50</b> ALPHA SERIES 5.0 OCTAVE ROSEWOOD MARIMBA (PLEASE SPECIFY ALPHA FINISH CODE) ..... | 20,596.00  |   |
|  | <b>MAHA-AC*</b> ALPHA ROSEWOOD "A TO C" CONVERSION KIT (PLEASE SPECIFY ALPHA FINISH CODE) ..... | 10,272.00  |   |
|  | <b>MAHA-CA*</b> ALPHA ROSEWOOD "C TO A" CONVERSION KIT (PLEASE SPECIFY ALPHA FINISH CODE) ..... | 1,456.00   |   |
|  | * SPECIAL ORDER   |            |   |

| ALPHA FINISH CODES        | ALPHA FINISH CODES      | ALPHA FINISH CODES          |
|---------------------------|-------------------------|-----------------------------|
| # RAILS / RESONATORS      | # RAILS / RESONATORS    | # RAILS / RESONATORS        |
| 9G1 GRAPHITE / BLACK      | 9T1 WALNUT / BLACK      | 9W1 WHITE WASH / BLACK      |
| 9G2 GRAPHITE / DESERT     | 9T2 WALNUT / DESERT     | 9W2 WHITE WASH / DESERT     |
| 9G3 GRAPHITE / SATIN GOLD | 9T3 WALNUT / SATIN GOLD | 9W3 WHITE WASH / SATIN GOLD |

## XYLOPHONES

|  |   |            |   |
|--|---|------------|---|
|  | <b>AXLD-35</b> ACADEMY SERIES 3.5 OCTAVE LIGHT ROSEWOOD w/X-STYLE STAND .....           | \$1,595.00 | * CAN BE USED ON A TABLE TOP OR WITH THE INCLUDED HEIGHT-ADJUSTABLE X-STYLE STAND<br>* INTEGRATED RESONATOR/RAIL SYSTEM * COVER & MALLETS INCLUDED  |
|  | <b>XSKV-35</b> SOLOIST 3.5 OCTAVE SYNTHETIC BARS w/VOYAGER FRAME .....                  | 3,390.00   | * SYNTHETIC BARS FEATURE SUPERIOR DURABILITY - IDEAL FOR SCHOOLS<br>* BARS: 1.5" (3.5 OCTAVE)<br>* BARS: 1.7"-1.5" (4.0 OCTAVE)<br>* TUNING: A=442 HZ<br>* HEIGHT-ADJUSTABLE VOYAGER OR ENDURANCE FIELD FRAME<br>* COVER & MALLETS INCLUDED |
|  | <b>XSKF-35</b> SOLOIST 3.5 OCTAVE SYNTHETIC BARS w/ENDURANCE FIELD FRAME .....          | 4,272.00   |   |
|  | <b>XSHV-40</b> SOLOIST 4.0 OCTAVE ROSEWOOD BARS w/VOYAGER FRAME .....                   | 5,476.00   |   |
|  | <b>XSHV-35</b> SOLOIST 3.5 OCTAVE ROSEWOOD BARS w/VOYAGER FRAME .....                   | 4,240.00   |   |
|  | <b>XCHV-40</b> CONCERT SERIES 4.0 OCTAVE ROSEWOOD BARS w/VOYAGER FRAME .....            | 6,778.00   | * TUNING: A=442 HZ, BARS: 1.9"-1.5"<br>* HEIGHT-ADJUSTABLE VOYAGER FRAME<br>* RAILS/RESONATORS FOLD IN HALF FOR EASE OF TRANSPORT<br>* COVER & MALLETS INCLUDED   |
|  | <b>XAHA40</b> ALPHA SERIES 4.0 OCTAVE ROSEWOOD (PLEASE SPECIFY ALPHA FINISH CODE) ..... | 7,666.00   |   |
|  |   |            |   |

| ALPHA FINISH CODES        | ALPHA FINISH CODES      | ALPHA FINISH CODES          |
|---------------------------|-------------------------|-----------------------------|
| # RAILS / RESONATORS      | # RAILS / RESONATORS    | # RAILS / RESONATORS        |
| 9G1 GRAPHITE / BLACK      | 9T1 WALNUT / BLACK      | 9W1 WHITE WASH / BLACK      |
| 9G2 GRAPHITE / DESERT     | 9T2 WALNUT / DESERT     | 9W2 WHITE WASH / DESERT     |
| 9G3 GRAPHITE / SATIN GOLD | 9T3 WALNUT / SATIN GOLD | 9W3 WHITE WASH / SATIN GOLD |

## VIBRAPHONES

|  |  |            |   |
|--|--|------------|---|
|  | <b>VSSV31M</b> SOLOIST - SILVER BARS 3.1 OCTAVE w/VOYAGER FRAME WITH MOTOR, E3-F6 .....      | \$6,248.00 | * TUNING: A=442 HZ<br>* MOTOR WITH SILENT PAUSE CONTROL<br>* GRADUATED ANODIZED SILVER BARS, OR GOLD BARS<br>* COVERED MOTOR & RUBBER BANDS FOR PROTECTION AGAINST OUTSIDE ELEMENTS<br>* ADVANCED DAMPENING SYSTEM w/PEDAL TENSION, DAMPER & HEIGHT ADJUSTMENT<br>* HEIGHT-ADJUSTABLE TRAVELER, VOYAGER OR ENDURANCE FIELD FRAME<br>* TOP-MOUNTED ON/OFF SWITCH & SPEED ADJUSTMENT CONTROL<br>* DUAL CLOSED/OPEN RESONATOR FAN SWITCH CONTROL<br>* COVER & MALLETS INCLUDED |
|  | <b>VSGV31M</b> SOLOIST - GOLD BARS 3.1 OCTAVE w/VOYAGER FRAME WITH MOTOR, E3-F6 .....        | 6,248.00   |   |
|  | <b>VCSV30M</b> CONCERT SERIES - SILVER BARS 3 OCTAVE w/VOYAGER FRAME WITH MOTOR, F3-F6 ..... | 6,686.00   |   |
|  | <b>VCGV30M</b> CONCERT SERIES - GOLD BARS 3 OCTAVE w/VOYAGER FRAME WITH MOTOR, F3-F6 .....   | 6,686.00   |   |
|  | <b>VCSF30M</b> CONCERT SERIES - SILVER BARS 3 OCTAVE w/FIELD FRAME WITH MOTOR, F3-F6 .....   | 7,524.00   |   |
|  | <b>VCGF30M</b> CONCERT SERIES - GOLD BARS 3 OCTAVE w/FIELD FRAME WITH MOTOR, F3-F6 .....     | 7,524.00   |   |
|  | <b>VCSF30</b> CONCERT SERIES - SILVER BARS 3 OCTAVE w/FIELD FRAME NO MOTOR, F3-F6 .....      | 6,686.00   |   |
|  | <b>VCGF30</b> CONCERT SERIES - GOLD BARS 3 OCTAVE w/FIELD FRAME NO MOTOR, F3-F6 .....        | 6,686.00   |   |
|  | <b>4VBBP01</b> LONG PEDAL EXTENSION ACCESSORY ADD-ON FOR TRAVELER & FIELD FRAMES .....       | 550.00     |   |
|  | <b>4VBBP02</b> LONG PEDAL EXTENSION ACCESSORY ADD-ON FOR VOYAGER .....                       | 550.00     |   |
|  | <b>VAST30M</b> ALPHA SERIES 3.0 OCTAVE w/SILVER BARS, MOTOR AND TRAVELER FRAME .....         | 7,248.00   |   |
|  | <b>VAGT30M</b> ALPHA SERIES 3.0 OCTAVE w/GOLD BARS, MOTOR AND TRAVELER FRAME .....           | 7,248.00   |   |
|  |  |            |   |

| ALPHA FINISH CODES        | ALPHA FINISH CODES      | ALPHA FINISH CODES          |
|---------------------------|-------------------------|-----------------------------|
| # RAILS / RESONATORS      | # RAILS / RESONATORS    | # RAILS / RESONATORS        |
| 9G1 GRAPHITE / BLACK      | 9T1 WALNUT / BLACK      | 9W1 WHITE WASH / BLACK      |
| 9G2 GRAPHITE / DESERT     | 9T2 WALNUT / DESERT     | 9W2 WHITE WASH / DESERT     |
| 9G3 GRAPHITE / SATIN GOLD | 9T3 WALNUT / SATIN GOLD | 9W3 WHITE WASH / SATIN GOLD |

## ADAMS CONCERT BASS DRUMS

### MAHOGANY w/ CLEAR LACQUER FINISH

### \*SPECIAL ORDER - EXTRA DELIVERY TIME REQUIRED

|  |   |            |  |   |            |  |  |            |
|--|---|------------|--|---|------------|--|--|------------|
|  | <b>ABDS2818*</b> 28"x18" w/STBD SUSPENDED STAND ..... | \$3,058.00 |  | <b>ABDS3222*</b> 32"x22" w/STBD SUSPENDED STAND ..... | \$3,538.00 |  | <b>ABDS4018</b> 40"x18" w/STBD SUSPENDED STAND ..... | \$4,180.00 |
|  | <b>ABDS2822*</b> 28"x22" w/STBD SUSPENDED STAND ..... | 3,058.00   |  | <b>ABDS3618*</b> 36"x18" w/STBD SUSPENDED STAND ..... | 3,748.00   |  | <b>ABDS4022</b> 40"x22" w/STBD SUSPENDED STAND ..... | 4,180.00   |
|  | <b>ABDS3218*</b> 32"x18" w/STBD SUSPENDED STAND ..... | 3,538.00   |  | <b>ABDS3622</b> 36"x22" w/STBD SUSPENDED STAND .....  | 3,748.00   |  | <b>ABDF4022</b> 40"x22" w/STBD & FIELD WHEELS .....  | 4,374.00   |

## BELLS & GLOCKENSPIELS

|               |  |                   |   |
|---------------|--|-------------------|---|
| <b>GCO-26</b> | <b>CONCERT SERIES 2.6 OCTAVE ORCHESTRA BELLS w/TOLEX CASE .....</b>                  | <b>\$3,390.00</b> | <ul style="list-style-type: none"> <li>• 1.25" HIGH-GRADE ROUND TOP BARS</li> <li>• 3.3 OCTAVE C-E</li> <li>• TUNING: AF=442 HZ</li> <li>• PATENT PENDING REVERSIBLE DAMPER SYSTEM</li> <li>• NICKEL PLATED STEEL RESONATORS</li> <li>• COVER &amp; MALLETS INCLUDED</li> </ul> |
| <b>GCV-33</b> | <b>CONCERT SERIES 3.3 OCTAVE (BLACK FRAME) - NO DAMPER PEDAL .....</b>               | <b>6,388.00</b>   |   |
| <b>GCF-33</b> | <b>CONCERT SERIES 3.3 OCTAVE (BLACK FRAME) w/FIELD FRAME - NO DAMPER PEDAL .....</b> | <b>6,832.00</b>   |   |
| <b>GAT-33</b> | <b>ARTIST SERIES 3.3 OCTAVE w/TRAVELER FRAME &amp; REVERSIBLE DAMPER PEDAL .....</b> | <b>6,804.00</b>   |   |
| <b>GAF-33</b> | <b>ARTIST SERIES 3.3 OCTAVE w/FIELD FRAME &amp; REVERSIBLE DAMPER PEDAL .....</b>    | <b>7,430.00</b>   |   |
| <b>GAN-33</b> | <b>ARTIST SERIES 3.3 OCTAVE GLOCKENSPIEL w/VINTAGE TUBE FRAME .....</b>              | <b>7,816.00</b>   |   |

## CHIMES

|                  |  |                   |   |
|------------------|--|-------------------|---|
| <b>BK-2001C</b>  | <b>STANDARD 1.5 OCTAVE (1.25" DIA TUBES) - CHROME PLATED .....</b>                         | <b>\$5,558.00</b> | <b>CHIME COMMON FEATURES:</b> <ul style="list-style-type: none"> <li>• PROPRIETARY BRASS ALLOY TUBES</li> <li>• HEIGHT-ADJUSTABLE ALUMINUM FRAME</li> <li>• DIRECT DAMPING</li> <li>• LARGE WHEELS &amp; BRAKES</li> <li>• COVER AND CHIME HAMMER INCLUDED</li> </ul>   |
| <b>BK-3003C</b>  | <b>SYMPHONIC 1.5 OCTAVE (1.5" DIA TUBES) - CHROME PLATED .....</b>                         | <b>7,274.00</b>   |   |
| <b>BK-3003CF</b> | <b>SYMPHONIC 1.5 OCTAVE (1.5" DIA TUBES) - CHROME PLATED w/ENDURANCE FIELD FRAME .....</b> | <b>8,186.00</b>   |   |
| <b>BK-3000C</b>  | <b>SYMPHONIC .5 OCTAVE EXTENDED RANGE (F4-B4) - CHROME PLATED - SPECIAL ORDER .....</b>    | <b>6,044.00</b>   |   |
| <b>BK-5003C</b>  | <b>PHILHARMONIC 1.5 OCTAVE - CHROME PLATED .....</b>                                       | <b>9,178.00</b>   |   |
| <b>BK-5003S</b>  | <b>*PHILHARMONIC 1.5 OCTAVE - SATIN PLATED - SPECIAL ORDER .....</b>                       | <b>9,178.00</b>   |   |
| <b>BK-5000C</b>  | <b>PHILHARMONIC .5 OCTAVE EXTENDED RANGE (F4-B4) - CHROME PLATED .....</b>                 | <b>6,752.00</b>   | <b>PHILHARMONIC EXCLUSIVE FEATURES:</b> <ul style="list-style-type: none"> <li>• EXTRA THICK TUBES PRODUCE CHURCH BELL QUALITY SOUND</li> <li>• PERFECT INTONATION UNRIVALED TONE QUALITY</li> <li>• AVAILABLE IN EITHER CHROME PLATING OR BRASS SATIN FINISH FOR ULTIMATE RESONANCE AND SOUND QUALITY</li> </ul> |
| <b>BK-5000S</b>  | <b>*PHILHARMONIC .5 OCTAVE EXTENDED RANGE (F4-B4) - SATIN PLATED - SPECIAL ORDER .....</b> | <b>6,752.00</b>   |   |
| <b>2BKFO5H</b>   | <b>ACCESSORY CHIME RACK - ADJ. HEIGHT, NO DAMPER-HOLDS 7x1.5" CHIME TUBES .....</b>        | <b>1,486.00</b>   |   |
| <b>BKF-05</b>    | <b>ACCESSORY CHIME RACK - NO DAMPER-HOLDS 7x1.5" CHIME TUBES .....</b>                     | <b>1,148.00</b>   |   |
| <b>MLBK</b>      | <b>ADAMS CHIME Mallet .....</b>  | <b>78.00</b>      |   |
| <b>213</b>       | <b>ENDURANCE FIELD FRAME ADD-ON BASE - FITS ALL ADAMS CHIMES .....</b>                     | <b>1,560.00</b>   |   |

\* SPECIAL ORDER

## BELL PLATES

|              |                                    |                   |
|--------------|------------------------------------|-------------------|
| <b>PKG-3</b> | <b>BERLIOZ BELL PLATE G3 .....</b> | <b>\$2,108.50</b> |
| <b>PKC-4</b> | <b>BERLIOZ BELL PLATE C4 .....</b> | <b>1,962.00</b>   |

## UNIVERSITY FRAMES

|                    |  |                   |                    |  |            |
|--------------------|--|-------------------|--------------------|--|------------|
| <b>NEW UFMAC50</b> | <b>RETRO-FIT FRAME FOR 5.0 ARTIST CLASSIC MARIMBA FRENCH OAK.....</b>  | <b>\$2,916.00</b> | <b>NEW UFMAH43</b> | <b>RETRO-FIT FRAME FOR 4.3 ARTIST CLASSIC MARIMBA BLACK TOLEX.....</b> | <b>TBD</b> |
| <b>NEW UFMAH50</b> | <b>RETRO-FIT FRAME FOR 5.0 ARTIST SERIES MARIMBA BLACK TOLEX.....</b>  | <b>2,916.00</b>   | <b>NEW UFMAC43</b> | <b>RETRO-FIT FRAME FOR 4.3 CLASSIC SERIES MARIMBA FRENCH OAK.....</b>  | <b>TBD</b> |
| <b>NEW UFMAH46</b> | <b>RETRO-FIT FRAME FOR 4.6 ARTIST SERIES MARIMBA BLACK TOLEX .....</b> | <b>TBD</b>        |                    |  |            |

REPLACES EXISTING VOYAGER OR ENDURANCE FIELD FRAME LEGS AND END CAPS

## ENDURANCE FIELD FRAMES

|               |  |                   |               |   |                   |
|---------------|--|-------------------|---------------|---|-------------------|
| <b>FFMS40</b> | <b>FIELD FRAME FOR SOLOIST 4.0 MARIMBA .....</b> | <b>\$1,690.00</b> | <b>FFXS35</b> | <b>FIELD FRAME - SOLOIST 3.5 XYLOPHONE .....</b>  | <b>\$1,482.00</b> |
| <b>FFMS43</b> | <b>FIELD FRAME FOR SOLOIST 4.3 MARIMBA .....</b> | <b>1,690.00</b>   | <b>FFXS40</b> | <b>FIELD FRAME - SOLOIST 4.0 XYLOPHONE .....</b>  | <b>1,482.00</b>   |
| <b>FFMC43</b> | <b>FIELD FRAME FOR CONCERT 4.3 MARIMBA .....</b> | <b>1,690.00</b>   | <b>FFXC40</b> | <b>FIELD FRAME - CONCERT 4.0 XYLOPHONE .....</b>  | <b>1,482.00</b>   |
| <b>FFMA43</b> | <b>FIELD FRAME FOR ARTIST 4.3 MARIMBA .....</b>  | <b>1,690.00</b>   | <b>FFVC30</b> | <b>FIELD FRAME - CONCERT 3.0 VIBRAPHONE .....</b> | <b>1,690.00</b>   |
| <b>FFMA46</b> | <b>FIELD FRAME FOR ARTIST 4.6 MARIMBA .....</b>  | <b>1,898.00</b>   | <b>FFGA33</b> | <b>FIELD FRAME - ARTIST 3.3 GLOCK .....</b>       | <b>1,695.00</b>   |
| <b>FFMA50</b> | <b>FIELD FRAME FOR ARTIST 5.0 MARIMBA .....</b>  | <b>1,898.00</b>   | <b>FFGC33</b> | <b>FIELD FRAME - CONCERT 3.3 GLOCK .....</b>      | <b>1,595.00</b>   |

## ENDURANCE FIELD FRAME PERCUSSION RACK SYSTEM

|                 |  |                   |                  |   |                 |
|-----------------|--|-------------------|------------------|---|-----------------|
| <b>FFRS-610</b> | <b>FIXED SIDE PANELS w/FIELD FRAME WHEELS &amp; PR 614 BRACES - SET OF 2 .....</b> | <b>\$1,304.00</b> | <b>FFRS-CLCR</b> | <b>ANGLE BRACES FOR EXTENSION ARMS - SET OF 2 .....</b> | <b>\$204.00</b> |
| <b>FFRSB-10</b> | <b>100CM FIXED CROSSBARS - SET OF 3 .....</b>                                      | <b>376.00</b>     | <b>FFRS-4</b>    | <b>40CM EXTENSION ARMS - SET OF 2 .....</b>             | <b>132.00</b>   |
| <b>FFRSB-15</b> | <b>150CM FIXED CROSSBARS - SET OF 3 .....</b>                                      | <b>460.00</b>     | <b>FFRS-6</b>    | <b>60CM EXTENSION ARMS - SET OF 2 .....</b>             | <b>152.00</b>   |
| <b>FFRSB-20</b> | <b>200CM FIXED CROSSBARS - SET OF 3 .....</b>                                      | <b>544.00</b>     | <b>FFRS-8</b>    | <b>80CM EXTENSION ARMS - SET OF 2 .....</b>             | <b>174.00</b>   |

## RACK SYSTEM ATTACHMENTS

|                  |   |                 |                |   |                 |
|------------------|---|-----------------|----------------|---|-----------------|
| <b>PTT1523MP</b> | <b>MALLET/STICK/TRAP TRAY w/CLAMP 15"x23" .....</b> | <b>\$229.00</b> | <b>CH-1030</b> | <b>CYMBAL HOLDER w/UNI-LOCK TILTER, 7/8" POST .....</b>     | <b>\$149.00</b> |
| <b>PTT1215MP</b> | <b>MALLET/STICK/TRAP TRAY w/CLAMP 12"x15" .....</b> | <b>219.00</b>   | <b>CH-930</b>  | <b>CYMBAL HOLDER w/UNI-LOCK TILTER, 7/8" POST .....</b>     | <b>99.00</b>    |
| <b>PCX-100</b>   | <b>PIPE CLAMP w/ADJUSTABLE JAWS .....</b>           | <b>49.00</b>    | <b>CH-830</b>  | <b>CYMBAL HOLDER w/GEAR TILTER, 7/8" POST .....</b>         | <b>69.00</b>    |
| <b>PCX-200</b>   | <b>PIPE CLAMP w/TILTING CLAMP .....</b>             | <b>55.00</b>    | <b>ADP-20</b>  | <b>CLAMP w/2 QUICK RELEASE JAWS (5/8" - 1 1/8") .....</b>   | <b>49.00</b>    |
|                  |   |                 | <b>AX-25</b>   | <b>CLAMP w/2 REVOLVING Q/R CLAMPS (1/2" - 1 1/8") .....</b> | <b>58.00</b>    |
|                  |   |                 | <b>AX-25L</b>  | <b>LONG VERSION OF THE AX-25 .....</b>                      | <b>65.00</b>    |

## ADAMS GONG STAND

|             |  |                 |
|-------------|--|-----------------|
| <b>ASGS</b> | <b>GONG STAND w/WHEELS - 2 ADJUSTABLE HANGING HOOKS &amp; BUILT-IN MALLET HOOK .....</b> | <b>\$652.00</b> |
| <b>626</b>  | <b>HANGING HOOKS FOR ASGS - 2 COMPLETE ASSEMBLIES .....</b>                              | <b>90.00</b>    |
| <b>627</b>  | <b>MALLET HOOK FOR ASGS - 1 COMPLETE ASSEMBLY .....</b>                                  | <b>45.00</b>    |

## BAGS / COVERS / CORDS

|                 |   |                 |                  |  |                   |
|-----------------|---|-----------------|------------------|--|-------------------|
| <b>MACV55</b>   | <b>SHORT COVER - 5.5 ARTIST CUSTOM MARIMBA MAHV55/MAHC55 .....</b>    | <b>\$126.00</b> | <b>CSAB-43</b>   | <b>ADAMS SOFT BAGS - 4.3 ARTIST MARIMBA - 2011 SPEC .....</b>        | <b>\$2,244.00</b> |
| <b>MACV50CC</b> | <b>SHORT COVER - 5.0 ARTIST CUSTOM MARIMBA MACC50 .....</b>           | <b>116.00</b>   | <b>CSAB-46</b>   | <b>ADAMS SOFT BAGS - 4.6 ARTIST MARIMBA - 2011 SPEC .....</b>        | <b>2,680.00</b>   |
| <b>MACV43CC</b> | <b>SHORT COVER - 4.3 ARTIST CUSTOM MARIMBA MACC43 .....</b>           | <b>84.00</b>    | <b>CSAB-50</b>   | <b>ADAMS SOFT BAGS - 5.0 ARTIST MARIMBA - 2011 SPEC .....</b>        | <b>2,814.00</b>   |
| <b>MACV-50</b>  | <b>SHORT COVER - 5.0 ARTIST MARIMBA MAHV50 / MAHC50 .....</b>         | <b>188.00</b>   | <b>CSCB-43</b>   | <b>ADAMS SOFT BAGS - 4.3 CONCERT MARIMBA - 2011 SPEC .....</b>       | <b>2,208.00</b>   |
| <b>MACV-46</b>  | <b>SHORT COVER - 4.6 ARTIST MARIMBA MAHV46 .....</b>                  | <b>188.00</b>   | <b>CSSB-43</b>   | <b>ADAMS SOFT BAGS - 4.3 SOLOIST MARIMBA - 2011 SPEC .....</b>       | <b>2,030.00</b>   |
| <b>MACV-43</b>  | <b>SHORT COVER - 4.3 ARTIST MARIMBA MAHV43 / MAHC43 .....</b>         | <b>188.00</b>   | <b>CSMBSA-30</b> | <b>ADAMS ACADEMY MARIMBA SOFT CASE w/WHEELS .....</b>                | <b>470.00</b>     |
| <b>MCCF-43</b>  | <b>SHORT COVER - 4.3 CONCERT MARIMBA w/FIELD FRAME MCKF43 .....</b>   | <b>142.00</b>   | <b>CSXBC-40</b>  | <b>ADAMS SOFT BAGS - 4.0 CONCERT XYLO - 2011 SPEC .....</b>          | <b>1,374.00</b>   |
| <b>MCCV-43</b>  | <b>SHORT COVER - 4.3 CONCERT MARIMBA MCHV43 / MCPV43 .....</b>        | <b>142.00</b>   | <b>CSXB-40</b>   | <b>ADAMS SOFT BAGS - 3.5 OR 4.0 SOLOIST XYLO - 2011 SPEC .....</b>   | <b>1,482.00</b>   |
| <b>MSCV-43</b>  | <b>SHORT COVER - 4.3 SOLOIST MARIMBA MSPV43 .....</b>                 | <b>142.00</b>   | <b>CSXB-35</b>   | <b>ADAMS SOFT BAGS - 3.5 SOLOIST XYLO - NEW 2011 .....</b>           | <b>1,504.00</b>   |
| <b>MSCV-40</b>  | <b>SHORT COVER - 4.0 SOLOIST MARIMBA MSPV40 .....</b>                 | <b>142.00</b>   | <b>CSXFSA-35</b> | <b>ADAMS ACADEMY XYLOPHONE SOFT CASE w/WHEELS .....</b>              | <b>414.00</b>     |
| <b>XCCV-40</b>  | <b>SHORT COVER - 4.0 CONCERT XYLOPHONE XCHV40 .....</b>               | <b>132.00</b>   | <b>CSVAC-30</b>  | <b>ADAMS SOFT BAGS - 3.0 ARTIST/CONCERT VIBES - NEW 2011 .....</b>   | <b>1,462.00</b>   |
| <b>XSCV-40</b>  | <b>SHORT COVER - 4.0 SOLOIST XYLOPHONE XSHV40 .....</b>               | <b>132.00</b>   | <b>CD-300</b>    | <b>CORD &amp; SPRINGS - XSHV35 .....</b>                             | <b>\$18.00</b>    |
| <b>XSCV-35</b>  | <b>SHORT COVER - 3.5 SOLOIST XYLOPHONE XSKV35 / XSHV35 .....</b>      | <b>132.00</b>   | <b>CD-301</b>    | <b>CORD &amp; SPRINGS - SYNTHETIC XYLO XSKF35 &amp; XSKV35 .....</b> | <b>18.00</b>      |
| <b>XSCF-35</b>  | <b>SHORT COVER - 3.5 SOLOIST XYLOPHONE w/FIELD FRAME XSKF35 .....</b> | <b>132.00</b>   | <b>CD-320</b>    | <b>CORD &amp; SPRINGS - MSPVJ30 .....</b>                            | <b>18.00</b>      |
| <b>CHCV-ST</b>  | <b>LONG COVER - 1.5 BK-2001C CHIME .....</b>                          | <b>320.00</b>   | <b>CD-350</b>    | <b>CORD &amp; SPRINGS - XSHV40 .....</b>                             | <b>24.00</b>      |
| <b>CHCV-SY</b>  | <b>LONG COVER - 1.5 BK-3003 / BK-5003 CHIMES .....</b>                | <b>320.00</b>   | <b>CD-351</b>    | <b>CORD &amp; SPRINGS - 3.0 VIBRAPHONE .....</b>                     | <b>30.00</b>      |
| <b>HC-501</b>   | <b>LONG COVER - 0.5 BK-3000 / BK-5000 CHIMES .....</b>                | <b>272.00</b>   | <b>CD-370</b>    | <b>CORD &amp; SPRINGS - MSPVJ40 OR XC2HV40 .....</b>                 | <b>30.00</b>      |
| <b>VBCV-30</b>  | <b>SHORT COVER - 3.0 CONCERT/ARTIST VIBE CV1 / AV1 .....</b>          | <b>148.00</b>   | <b>CD-390</b>    | <b>CORD &amp; SPRINGS - XCHV40 .....</b>                             | <b>30.00</b>      |
| <b>VBCF-30</b>  | <b>SHORT COVER - 3.0 CONCERT VIBE w/FIELD FRAME CV1F / CV2F .....</b> | <b>148.00</b>   | <b>CD-420</b>    | <b>CORD &amp; SPRINGS - MSPV43 OR MSHV43 .....</b>                   | <b>30.00</b>      |
| <b>HS-214</b>   | <b>SHORT COVER - 3.3 GAV / GAC GLOCK .....</b>                        | <b>100.00</b>   | <b>CD-470</b>    | <b>CORD &amp; SPRINGS - 4.3 ARTIST/CONCERT MARIMBAS .....</b>        | <b>42.00</b>      |
|                 |   |                 | <b>CD-471</b>    | <b>CORD &amp; SPRINGS - 4.3 SYNTHETIC MCKF43 &amp; MCKV43 .....</b>  | <b>42.00</b>      |
|                 |   |                 | <b>CD-530</b>    | <b>CORD &amp; SPRINGS - 4.6 ARTIST MARIMBAS .....</b>                | <b>42.00</b>      |
|                 |   |                 | <b>CD-570</b>    | <b>CORD &amp; SPRINGS - 5.0 ARTIST MARIMBAS .....</b>                | <b>42.00</b>      |

# ED KITS & COMPONENTS

**PL-900C PERC. LEARNING CENTER w/PLBC-9 NYLON CARRYING CASE w/WHEELS ..... \$599.00**

• SK-1335P 13"x3.5" WOOD SNARE • 8" REMO TUNEABLE PRACTICE PAD • MUSIC RACK • PKB-32 BELL STAND  
• 2.5 OCTAVE BELLS (F5-C8) • MALLETS w/25MM HEADS & WOOD HANDLES • S-70A SNARE BASKET • 5A STICKS

**PK-900 PERCUSSION KIT w/PKB-9 NYLON BACKPACK-STYLE CARRYING CASE ..... \$379.00**

• 2.5 OCTAVE BELLS (F5-C8) • 8" REMO TUNEABLE PRACTICE PAD • 5A STICKS  
• MALLETS w/25MM HEADS & WOOD HANDLES • PKB-32 BELL/PAD STAND • MUSIC RACK

**SK-900 SNARE KIT w/SKB-9 NYLON BACKPACK-STYLE CARRYING CASE ..... \$329.00**

• SK-1455 14"x5.5" STEEL SNARE • "GLADSTONE" STYLE PRACTICE PAD  
• S-700L SNARE STAND • 5A STICKS

**SK-900C SNARE KIT w/SKBC-9 NYLON BACKPACK-STYLE CARRYING CASE w/WHEELS ..... 369.00**

## BELLS & BELL ACCESSORIES

**PKB-32 (F5-C8) 32 NOTE BELL SECTION COMPLETE ... \$217.50**  
**PR702A MUSIC RACK ..... 12.50**

## PRACTICE PADS

**RT08PL 8" REMO TUNABLE PRACTICE PAD ..... \$51.00**  
**RPG-14 14" 2-LEVEL PRACTICE PAD ..... 35.00**

\*SEE PG 17 FOR REPLACEMENT PAD HEADS

## CARRYING BAGS/CASES & PARTS

**SKB-9 SK-900 CARRYING BAG (ALSO FITS SK-800) ..... \$106.00**  
**SKBC-9 SK-900C BAG w/WHEELS (ALSO FITS SK-800C) ..... 149.50**  
**PKB-9 PK-900 CARRYING BAG (ALSO FITS PK-800) ..... 118.00**  
**PKBC-9 PK-900C BAG w/WHEELS (ALSO FITS PK-800C) ..... 161.50**  
**PLBC-9 PL-900C BAG w/WHEELS ..... 174.00**  
**CRT-100 WHEELED CART ONLY ..... 65.00**

## SNARE DRUMS

**SK-1335P 13"x3.5" WOOD - #31 JET BLACK ..... \$154.50**  
**SK-1455 14"x5.5" STEEL w/0 MUTE - HAIRLINE NICKEL ..... 223.00**

## STICKS & MALLETS

**SPK-5A 5A STICKS ..... \$19.00**  
**PXB-5N BELL MALLETS (WOOD HANDLE) ..... 15.50**

## STANDS

**PK-800ST BELL/PRACTICE PAD STAND - PK-800 & PL-800 .. \$56.50**  
**S-700L SNARE DRUM STAND ..... 129.00**  
**S-70A SNARE STAND BASKET (ONLY) ..... 93.50**

# REPLACEMENT HEADS - MARCHING / CONCERT / LOGO STICKERS

## MARCHING BASS HEADS - PEARL LOGO

**14" BR-1214PL SMOOTH WHITE ..... \$62.00**  
**16" BR-1216PL SMOOTH WHITE ..... 64.30**  
**18" BR-1218PL SMOOTH WHITE ..... 66.10**  
**20" BR-1220PL SMOOTH WHITE ..... 68.90**  
**22" BR-1222PL SMOOTH WHITE ..... 73.30**  
**24" BR-1224PL SMOOTH WHITE ..... 78.20**  
**26" BR-1226PL SMOOTH WHITE ..... 87.40**  
**28" BR-1228PL SMOOTH WHITE ..... 94.30**  
**30" BR-1230PL SMOOTH WHITE ..... 102.00**  
**32" BR-1232PL SMOOTH WHITE ..... 109.20**  
**14" ES-1014-00\* EBONY ..... 63.60**  
**16" ES-1016-00\* EBONY ..... 67.00**  
**18" ES-1018-00\* EBONY ..... 70.50**  
**20" ES-1020-00\* EBONY ..... 75.50**  
**22" ES-1022-00\* EBONY ..... 79.50**  
**24" ES-1024-00\* EBONY ..... 83.80**  
**26" ES-1026-00\* EBONY ..... 89.70**  
**28" ES-1028-00\* EBONY ..... 95.80**  
**30" ES-1030-00\* EBONY ..... 109.00**  
**32" ES-1032-00\* EBONY ..... 114.00**

\*SPECIAL ORDER

## CONCERT BASS HEADS - PEARL LOGO

**28" FA-1528-PL FIBERSKYN III ..... \$112.50**  
**32" FA-1532-PL FIBERSKYN III ..... 139.70**  
**36" FA-1536-PL FIBERSKYN III ..... 169.10**  
**40" FA-1540-PL FIBERSKYN III ..... 205.30**  
**28" N3-3028-PL\* NUSKYN ..... 115.80**  
**32" N3-3032-PL\* NUSKYN ..... 148.10**  
**36" N3-3036-PL\* NUSKYN ..... 188.00**  
**40" N3-3040-PL\* NUSKYN ..... 325.50**

## PEARL LOGO STICKERS

**PHD1BMP BLACK DECAL 13"x5.5" ..... \$3.50**  
**PHD1WMP WHITE DECAL 13"x5.5" ..... 3.50**  
**PHD1B BLACK DECAL 9"x4" ..... 3.50**  
**PHD1W WHITE DECAL 9"x4" ..... 3.50**  
**CP1 WHITE DIE-CUT 6"x2.5" ..... 3.50**  
**CP2 BLACK DIE-CUT 6"x2.5" ..... 3.50**  
**CP3 REFLECTIVE DIE-CUT 6"x2.5" ..... 3.50**  
**CP4 GLOW-IN-THE-DARK 6"x2.5" ..... 3.50**  
**CP1MP WHITE DIE-CUT 7.25"x3" ..... 3.50**  
**CP2MP BLACK DIE-CUT 7.25"x3" ..... 3.50**  
**CP1S WHITE DIE-CUT 5.7"x2" ..... 3.50**  
**CP2S BLACK DIE-CUT 5.7"x2" ..... 3.50**

## MARCHING TOM HEADS

**6" PS-0306MP PINSTRIPE ..... \$29.50**  
**8" PS-0308MP PINSTRIPE ..... 32.30**  
**10" PS-0310MP PINSTRIPE ..... 33.60**  
**12" PS-0312MP PINSTRIPE ..... 35.60**  
**13" PS-0313MP PINSTRIPE ..... 37.40**  
**14" PS-0314MP PINSTRIPE ..... 39.00**  
**6" CT-6 PEARL CLEAR ..... 15.50**  
**8" CT-8 PEARL CLEAR ..... 16.50**  
**10" CT-10 PEARL CLEAR ..... 17.50**  
**12" CT-12 PEARL CLEAR ..... 18.50**  
**13" CT-13 PEARL CLEAR ..... 19.50**  
**14" CT-14 PEARL CLEAR ..... 20.50**  
**15" CT-15 PEARL CLEAR ..... 21.00**  
**16" CT-16 PEARL CLEAR ..... 22.00**

## MARCHING SNARE HEADS - KEVLAR

**13" KS-0213-C2 FALAM II w/CLEAR DOT ... \$80.00**  
**14" KS-0214-C2 FALAM II w/CLEAR DOT ..... 81.70**  
**13" KS-0613-00 BLACK MAX ..... 96.60**  
**14" KS-0614-00 BLACK MAX ..... 98.90**  
**13" KS-2613-00 WHITE MAX ..... 96.60**  
**14" KS-2614-00 WHITE MAX ..... 98.90**  
**14" KS-0524-00 CYBERMAX ..... 103.80**  
**13" KL-0213-SA SNARE HEAD ..... 73.80**  
**14" KL-0214-SA SNARE HEAD ..... 75.60**

## MARCHING SNARE HEADS - PEARL

**13" CC-13 CLEAR BATTER w/CLEAR DOT ... \$17.50**  
**14" CC-14 CLEAR BATTER w/CLEAR DOT ..... 20.50**  
**13" ST-13 CLEAR SNARE HEAD ..... 14.50**  
**14" ST-14 CLEAR SNARE HEAD ..... 15.50**

# REPLACEMENT HEADS - TIMPANI

## TIMPANI - PHILHARMONIC

| BOWL SIZE | RENAISSANCE         | CALFSKIN SKIN ONLY | CALFSKIN COMPLETE SQUARE FLESH HOOP |
|-----------|---------------------|--------------------|-------------------------------------|
| 20"       | RC-2300-RA \$173.70 | -                  | 4NVLVP20 \$1,816.00                 |
| 23"       | RC-2508-RA 183.70   | CATH-23 1,212.00   | 4NVLVP23 1,834.00                   |
| 25"       | RC-2708-RA 191.40   | -                  | 4NVLVP25 1,934.00                   |
| 26"       | RC-2808-RA 195.80   | CATH-26 1,288.00   | 4NVLVP26 1,934.00                   |
| 28"       | RC-3008-RA 208.80   | -                  | 4NVLVP28 2,246.00                   |
| 29"       | RC-3200-RA 213.50   | CATH-29 1,600.00   | 4NVLVP29 2,246.00                   |
| 30"       | RC-3300-RA 215.30   | -                  | 4NVLVP30 2,264.00                   |
| 32"       | RC-3412-RA 220.90   | CATH-32 1,896.00   | 4NVLVP32 2,560.00                   |

## TIMPANI - SYMPHONIC / PROFESSIONAL / UNIVERSAL / REVOLUTION

| BOWL SIZE | RENAISSANCE         | WEATHERKING HAZY   |
|-----------|---------------------|--------------------|
| 20"       | RC-2200-RA \$169.40 | TI-2200-00 \$78.70 |
| 23"       | RC-2500-RA 182.50   | TI-2500-00 87.60   |
| 26"       | RC-2800-RA 193.50   | TI-2800-00 93.00   |
| 29"       | RC-3100-RA 210.40   | TI-3100-00 98.90   |
| 32"       | RC-3400-RA 219.40   | TI-3400-00 115.30  |

## TIMPANI - SYMPHONIC / REVOLUTION

| BOWL SIZE | CALFSKIN COMPLETE SQUARE FLESH HOOP |
|-----------|-------------------------------------|
| 20"       | 4NVPV20 \$1,786.00                  |
| 23"       | 4NVPV23 1,802.00                    |
| 26"       | 4NVPV26 1,808.00                    |
| 29"       | 4NVPV29 2,214.00                    |
| 32"       | 4NVPV32 2,520.00                    |

# REPLACEMENT HOOPS - MARCHING / CONCERT / PIPE BAND

## CHAMPIONSHIP BASS DRUMS

**14" RIM-14PB 2" WIDE MATTE BLACK .. \$77.00**  
**16" RIM-16PB 2" WIDE MATTE BLACK .... 79.00**  
**18" RIM-18PB 2" WIDE MATTE BLACK ... 85.00**  
**20" RIM-20PB 2" WIDE MATTE BLACK .... 90.50**  
**22" RIM-22PB 2" WIDE MATTE BLACK ... 101.50**  
**24" RIM-24PB 2" WIDE MATTE BLACK ... 113.00**  
**26" RIM-26PB 2" WIDE MATTE BLACK ... 124.50**  
**28" RIM-28PB 2" WIDE MATTE BLACK ... 147.00**  
**30" RIM-30PB 2" WIDE MATTE BLACK ... 163.50**  
**32" RIM-32PB 2" WIDE MATTE BLACK ... 192.00**  
**14" RIM-14PBJ 2" WIDE GLOSS BLACK .. 90.00**  
**16" RIM-16PBJ 2" WIDE GLOSS BLACK ... 97.00**  
**18" RIM-18PBJ 2" WIDE GLOSS BLACK ... 104.00**  
**20" RIM-20PBJ 2" WIDE GLOSS BLACK ... 111.00**  
**22" RIM-22PBJ 2" WIDE GLOSS BLACK ... 124.50**  
**24" RIM-24PBJ 2" WIDE GLOSS BLACK ... 138.00**  
**26" RIM-26PBJ 2" WIDE GLOSS BLACK ... 152.00**  
**28" RIM-28PBJ 2" WIDE GLOSS BLACK ... 179.50**  
**30" RIM-30PBJ 2" WIDE GLOSS BLACK ... 200.00**  
**32" RIM-32PBJ 2" WIDE GLOSS BLACK ... 234.50**

## COMPETITOR BASS DRUMS

**14" RIM-14CB 1.5" WIDE MATTE BLACK .. \$67.00**  
**16" RIM-16CB 1.5" WIDE MATTE BLACK ... 69.50**  
**18" RIM-18CB 1.5" WIDE MATTE BLACK ... 79.50**  
**20" RIM-20CB 1.5" WIDE MATTE BLACK ... 85.00**  
**22" RIM-22CB 1.5" WIDE MATTE BLACK ... 90.00**  
**24" RIM-24CB 1.5" WIDE MATTE BLACK ... 97.50**  
**26" RIM-26CB 1.5" WIDE MATTE BLACK ... 113.00**  
**28" RIM-28CB 1.5" WIDE MATTE BLACK ... 128.50**  
**14" RIM-14CBJ 1.5" WIDE GLOSS BLACK ... 79.50**  
**16" RIM-16CBJ 1.5" WIDE GLOSS BLACK ... 83.50**  
**18" RIM-18CBJ 1.5" WIDE GLOSS BLACK ... 90.00**  
**20" RIM-20CBJ 1.5" WIDE GLOSS BLACK ... 97.00**  
**22" RIM-22CBJ 1.5" WIDE GLOSS BLACK ... 104.00**  
**24" RIM-24CBJ 1.5" WIDE GLOSS BLACK ... 117.50**  
**26" RIM-26CBJ 1.5" WIDE GLOSS BLACK ... 131.50**  
**28" RIM-28CBJ 1.5" WIDE GLOSS BLACK ... 145.50**

## CONCERT BASS DRUMS

**28" RIM-28PB 2" WIDE MATTE BLACK .. \$143.00**  
**32" RIM-32PB 2" WIDE MATTE BLACK .... 187.00**  
**36" RIM-36PB 2" WIDE MATTE BLACK .... 190.00**

## FFX / FFXP DIE CAST HOOPS

**13" DA-13T 10 LUG BATTER ..... \$97.50**  
**13" DA-13B 10 LUG SNARE w/ME-262NA STEEL GUARDS 97.50**  
**13" DA-13BNN 10 LUG SNARE w/AL-93A ALUM. GUARDS ... 97.50**  
**14" DA-14T 12 LUG BATTER ..... 97.50**  
**14" DA-14B 12 LUG SNARE w/ME-262NA STEEL GUARDS 97.50**  
**14" DA-14BNN 12 LUG SNARE w/AL-93A ALUM. GUARDS ... 97.50**  
**ME-262NA STEEL GUARD (1) ..... 6.00**  
**AL-93A ALUMINUM GUARD (1) ..... 11.50**

## PIPE TENOR 1" WOOD HOOPS

**14" RIM-14TDP ..... \$108.00**  
**15" RIM-15TDP ..... 113.00**  
**16" RIM-16TDP ..... 118.00**  
**18" RIM-18TDP ..... 133.50**

**NOTE - PLEASE REFER TO PAGE 23 FOR:  
CONCERT DIE CAST  
SUPERHOOP II  
SINGLE FLANGE  
1.6MM HOOPS**

## REPLACEMENT SNARES - MARCHING / CONCERT / PIPE BAND

### PHILHARMONIC

|          |  |         |
|----------|--|---------|
| S-052    | 14" 6 STRAND LIGHT CABLE w/CORDS                   | \$25.00 |
| S-064    | 14" 4 STRAND SNAPPY                                | 12.50   |
| S-065Y   | 14" 5 STRAND HEAVY YELLOW CABLE - GRAD. TENSION    | 76.00   |
| S-065YE  | 14" 5 STRAND HEAVY YELLOW CABLE - EVEN TENSION     | 81.50   |
| S-067YT  | 14" 7 STRAND LIGHT YELLOW CABLE - GRAD. TENSION    | 92.50   |
| S-068S   | 14" 8 STRAND STAINLESS STEEL CABLE - EVEN TENSION  | 92.50   |
| S-068SGT | 14" 8 STRAND STAINLESS STEEL CABLE - GRAD. TENSION | 90.50   |
| C-1505SG | 15" 5 STRAND SYNTHETIC GUT                         | 39.00   |
| C1505GT  | 15" 5 STRAND HEAVY YELLOW - GRAD. TENSION          | 76.00   |
| S-165Y   | 16" 5 STRAND HEAVY YELLOW CABLE - GRAD. TENSION    | 81.50   |
| S-165YE  | 16" 5 STRAND HEAVY YELLOW CABLE - EVEN TENSION     | 81.50   |
| S-168S   | 16" 8 STRAND STAINLESS STEEL CABLE - EVEN TENSION  | 92.50   |
| S-368SGT | 13" 8 STRAND UNCOATED STAINLESS CABLE - GT         | 79.00   |
| S-352    | 13" 6 STRAND LIGHT CABLE - EVEN TENSION            | 25.50   |
| S-368S   | 13" 8 STRAND UNCOATED STAINLESS CABLE - ET         | 79.00   |
| DC-534A  | SNARE CABLE CLAMP - SR-500 STRAINER                | 5.50    |
| SGR1/2   | SNARE GUIDE (PR) - DIE CAST HOOPS                  | 6.00    |

### SYMPHONIC

|       |                                  |         |
|-------|----------------------------------|---------|
| S-051 | 14" 6 STRAND SNAPPY w/CORDS      | \$12.50 |
| S-052 | 14" 6 STRAND LIGHT CABLE w/CORDS | 25.00   |
| S-053 | 14" 6 STRAND HEAVY BLUE CABLE    | 43.00   |

### CONCERT

|       |                           |          |
|-------|---------------------------|----------|
| S-077 | CRP SNARE DRUM SNARE UNIT | \$141.00 |
|-------|---------------------------|----------|

### MARCHING

|         |                                      |         |
|---------|--------------------------------------|---------|
| GS-416A | 16 STRAND GUT - 14" FFX1412          | \$92.50 |
| GS-316A | 16 STRAND GUT - 13" FFX1311/FFXS1309 | 92.50   |
| GS-142  | SYNTHETIC GUT - 14" CMS/CMSX1412     | 61.50   |
| GS-132  | SYNTHETIC GUT - 13" CMS/CMSX1311     | 61.50   |

### PIPE DRUM

|            |                                  |         |
|------------|----------------------------------|---------|
| S-505TCPRC | 28 STRAND TOP - PREMIER STYLE    | \$27.00 |
| S-505SPRC  | 20 STRAND BOTTOM - PREMIER STYLE | 24.00   |

## REPLACEMENT PARTS - MARCHING / CONCERT / PIPE BAND

### CHAMPIONSHIP FFX SNARES

|             |                                       |         |
|-------------|---------------------------------------|---------|
| S-115RA     | STRAINER - THROWOFF SIDE COMPLETE     | \$51.50 |
| S-115BA     | STRAINER - BUTT SIDE COMPLETE         | 31.00   |
| ER-14       | EDGE RING - 14" FFX                   | 138.50  |
| ER-13       | EDGE RING - 13" FFX                   | 138.50  |
| TSP-102N    | TENSION POST - FFX1412 w/STD. FINISH  | 6.50    |
| TSP-102N/K  | TSP-102N w/SHINY ANODIZED FINISH      | 15.50   |
| TSP-1020A/K | FOR FFX1410 w/SHINY ANODIZED FINISH   | 15.50   |
| TSP-103N    | TENSION POST - FFX1311 w/STD. FINISH  | 6.50    |
| TSP-103N/K  | TSP-103N w/SHINY ANODIZED FINISH      | 15.50   |
| TSP-1039A/K | FOR FFX1309 w/SHINY ANODIZED FINISH   | 15.50   |
| T-054/6     | TENSION ROD w/WASHER 6MMx54MM (6/PK)  | 7.00    |
| RG-56/24    | ROD GUARDS 6MM (24/PK)                | 7.00    |
| ME-262      | BOTTOM SNARE GUARD w/HEX NUTS - STEEL | 6.50    |
| NEW AL-93A  | BOTTOM SNARE GUARD w/HEX NUTS - ALUM  | 11.50   |

### CHAMPIONSHIP BASS DRUMS

|           |   |         |
|-----------|---|---------|
| C-072AL   | LUG - FITS ALL CHAMPIONSHIP BD SIZES          | \$12.50 |
| DC-5FN/12 | SWIVEL NUT (12/PK)                            | 8.50    |
| T-066     | TEN. ROD w/WASHER 16"-28" BD 6MMx115MM        | 4.50    |
| T-067/2   | TEN. ROD w/WASHER 30"-32" BD 6MMx130MM (2/PK) | 5.00    |
| RG-56/24  | ROD GUARDS 6MM (24/PK)                        | 7.00    |
| D-042     | CLAW  | 4.00    |
| EB-1      | EYE BOLT ASSY. COMPLETE                       | 6.50    |

### CHAMPIONSHIP TOMS

|           |                                      |        |
|-----------|--------------------------------------|--------|
| C-055AL   | LUG COMPLETE                         | \$8.00 |
| DC-5FN/12 | SWIVEL NUT (12/PK)                   | 8.50   |
| T-054/6   | TENSION ROD w/WASHER 6MMx54MM (6/PK) | 7.00   |
| RG-56/24  | ROD GUARDS 6MM (24/PK)               | 7.00   |
| TS-150    | TOM SPACER ASSY. COMPLETE            | 18.50  |
| MTT-100   | TOM TRIM 15"                         | 27.50  |
| NP-246A/4 | TOM TRIM END BRACKETS (4/PK)         | 4.50   |

### COMPETITOR SNARE DRUMS

|            |  |         |
|------------|--|---------|
| S-14MRA    | STRAINER - THROWOFF SIDE COMPLETE                | \$36.00 |
| S-14MBA    | STRAINER - BUTT SIDE COMPLETE                    | 36.00   |
| ER-14      | EDGE RING - CMX1412/C                            | 138.50  |
| ER-13      | EDGE RING - CMX1311/C                            | 138.50  |
| TSP-102N/K | TENSION POST - CMX1412/C w/SHINY ANODIZED FINISH | 15.50   |
| TSP-103N/K | TENSION POST - CMX1311/C w/SHINY ANODIZED FINISH | 15.50   |
| T-054/6    | TEN. ROD w/WASHER - CMX1412/C & 1311/C (6/PK)    | 7.00    |
| HLN-12S    | 3PC TENSION LUG COMPLETE - CMX1412/C             | 15.50   |
| HLN-11S    | 3PC TENSION LUG COMPLETE - CMS1311/C             | 15.50   |
| DC-6FE/12  | SWIVEL NUT - HLN-12S/HLN-11S (12/PK)             | 9.50    |
| T-056/6    | TEN. ROD w/WASHER - CMS1412/C & 1311/C (6/PK)    | 5.50    |
| CT-1216    | CLIP BRACKET ASSY. COMPLETE                      | 15.50   |

### COMPETITOR BASS DRUMS

|         |                                |         |
|---------|--------------------------------|---------|
| HLN-14B | 3PC TENSION LUG COMPLETE       | \$14.50 |
| DC-5FE  | SWIVEL NUT (1 @)               | 3.00    |
| T-066   | TENSION ROD w/WASHER 6MMx115MM | 4.50    |
| D-042   | CLAW                           | 4.00    |
| EB-1    | EYE BOLT ASSY. COMPLETE        | 6.50    |

### COMPETITOR TOMS

|           |  |         |
|-----------|--|---------|
| SLN-10T   | LUG COMPLETE                           | \$14.50 |
| DC-6FE/12 | SWIVEL NUT (12/PK)                     | 9.50    |
| T-056/6   | TENSION ROD w/WASHER 5.8MMx56MM (6/PK) | 5.50    |
| TS-150    | TOM SPACER ASSY. COMPLETE              | 18.50   |
| MTT-100   | TOM TRIM 15"                           | 20.50   |
| NP-246A/4 | TOM TRIM END BRACKETS (4/PK)           | 4.50    |

### PIPE SNARE DRUMS

|            |  |          |
|------------|--|----------|
| SR-505T    | TOP SNARE UNIT COMPLETE                    | \$113.00 |
| SR-505B    | BOTTOM SNARE UNIT COMPLETE (ONE SIDE ONLY) | 72.00    |
| ER-14PBP   | EDGE RING                                  | 138.50   |
| TSP-102N/K | TENSION POST LONG w/SHINY ANODIZED FINISH  | 15.50    |
| TSP-102S/K | TENSION POST SHORT w/SHINY ANODIZED FINISH | 15.50    |
| T-054/6    | TENSION ROD w/WASHER 6MMx54MM (6/PK)       | 7.00     |
| RG-56/24   | ROD GUARDS 6MM (24/PK)                     | 7.00     |
| ME-262     | BOTTOM SNARE GUARD w/HEX NUTS              | 6.50     |
| AL-93A     | BOTTOM SNARE GUARD w/HEX NUTS - ALUM       | 11.50    |

### BDP & PB PIPE BASS DRUMS

|           |  |         |
|-----------|--|---------|
| TSP-12P   | T-POST - 12" & 14" DEPTH - STD. FINISH           | \$18.00 |
| TSP-16P   | T-POST - 16" DEPTH - STD. FINISH                 | 20.00   |
| TSP-12P/K | T-POST - 12" & 14" DEPTH - SHINY ANODIZED FINISH | 20.50   |
| TSP-16P/K | T-POST - 16" DEPTH - SHINY ANODIZED FINISH       | 21.50   |
| HLN-12B   | 3PC TENSION LUG COMPLETE - 12" DEPTH PB          | 12.50   |
| HLN-14B   | 3PC TENSION LUG COMPLETE - 14" DEPTH PB          | 14.50   |
| HLN-16B   | 3PC TENSION LUG COMPLETE - 16" DEPTH PB          | 24.00   |
| DC-5FE    | SWIVEL NUT (1 @) - HLN-12B/14B/16B               | 3.00    |
| T-066     | TENSION ROD w/WASHER 6MMx115MM - 12" ~ 16"       | 4.50    |
| T-067/2   | TENSION ROD w/WASHER 6MMx135MM - 14" (2/PK)      | 5.00    |
| D-054     | CLAW - BDP BASS DRUM                             | 8.00    |
| D-042     | CLAW - PB BASS DRUM                              | 4.00    |
| RG-56/24  | ROD GUARDS 6MM (24/PK)                           | 7.00    |
| EB-1      | EYE BOLT ASSY. COMPLETE                          | 6.50    |

### TDP PIPE TENOR DRUMS

|           |  |         |
|-----------|--|---------|
| TSP-12P   | T-POST - 12" DEPTH - STD. FINISH           | \$18.00 |
| TSP-12P/K | T-POST - 12" DEPTH - SHINY ANODIZED FINISH | 20.50   |
| T-065     | TENSION ROD w/WASHER 6MMx90MM FOR 1" HOOP  | 4.50    |
| D-054     | CLAW                                       | 8.00    |
| PR-495A   | SLING HOOK w/SPACER                        | 2.50    |

### PTD PIPE TENOR DRUMS

|           |                                      |         |
|-----------|--------------------------------------|---------|
| HL-312T   | 3PC TENSION LUG COMPLETE             | \$10.00 |
| DC-6FE/12 | SWIVEL NUT (12/PK)                   | 9.50    |
| T-054/6   | TENSION ROD w/WASHER 6MMx54MM (6/PK) | 7.00    |
| PR-495    | SLING HOOK                           | 1.50    |

## REPLACEMENT PARTS - PHILHARMONIC / SYMPHONIC / CONCERT SNARE DRUMS

### PHILHARMONIC

|         |   |          |
|---------|---|----------|
| SR-500  | TRIAD SILENT STRAINER COMPLETE          | \$113.00 |
| SR-500A | TRIAD SILENT STRAINER RELEASE SIDE ONLY | 68.00    |
| SR-500E | TRIAD SILENT STRAINER BUTT SIDE ONLY    | 45.50    |

### SYMPHONIC

|         |   |          |
|---------|---|----------|
| SR-300  | MULTI-TIMBRE STRAINER COMPLETE          | \$101.50 |
| SR-300A | MULTI-TIMBRE STRAINER RELEASE SIDE ONLY | 88.50    |
| SR-300E | MULTI-TIMBRE STRAINER BUTT SIDE ONLY    | 14.00    |

### CONCERT

|        |                   |         |
|--------|-------------------|---------|
| SR-017 | STRAINER COMPLETE | \$50.00 |
| SR-17A | RELEASE SIDE ONLY | 33.00   |
| SR-18E | BUTT SIDE ONLY    | 16.50   |

# MARCHING & CONCERT COLORS

## COMPETITOR SERIES

- 33 PURE WHITE
- 46 MIDNIGHT BLACK

## CARBONPLY SERIES

- 301 CARBON MATTE FINISH

## CARBONCORE SERIES

- 368 BLACK SILVER BURST

PLUS: ALL MARCHING  
SPECIAL ORDER LACQUER  
FINISHES

## CHAMPIONSHIP MAPLE

### Standard Wrap

- 33 PURE WHITE
- 46 MIDNIGHT BLACK

### \*Standard Lacquer Finish

- 360 SILVER SPARKLE LACQUER  
\* FOR NEW SPEC ONLY

### Special Order Wrap

- 21 SMOKEY CHROME
- 26 BRUSHED SILVER
- 42 IVORY
- 91 RED WINE
- 92 AURORA BLUE
- 94 CANDY APPLE
- 400 WHITE MARINE PEARL\*
- 402 ABALONE\*
- 404 AMETHYST\*
- 406 BRONZE GLASS\*
- 407 RED GLASS\*
- 408 PEWTER GLASS\*
- 409 DIAMOND GLITTER\*

PLUS: ALL MARCHING  
SPECIAL ORDER LACQUER  
FINISHES

\*ALL "400" COVERED  
FINISHES ARE SUBJECT TO  
LACQUER PRICING.

## MARCHING SPECIAL ORDER LACQUERS

- 100 WINE RED LACQUER
- 101 WALNUT LACQUER
- 102 NATURAL MAPLE
- 103 PIANO BLACK
- 109 ARCTIC WHITE
- 110 SEQUOIA RED
- 111 MATTE NATURAL MAPLE
- 113 SHEER BLUE
- 122 BLACK MIST
- 124 MATTE BLACK MIST
- 125 TEAL BLUE
- 126 EMERALD MIST
- 128 VINTAGE SUNBURST
- 142 ROOTBEER FADE
- 143 TWILIGHT FADE
- 148 EMERALD FADE
- 151 PLATINUM MIST
- 152 ANTIQUE GOLD
- 153 SUNRISE FADE
- 154 MIDNIGHT FADE
- 155 SCARLET FADE
- 197 RHYTHM BLUE
- 201 MATTE WALNUT
- 230 CLEAR BIRCH
- 232 RUBY FADE
- 234 BLACK ICE
- 235 CONCORD FADE
- 238 BLACK BURST
- 239 GRAPHITE
- 243 PRUSSIAN BLUE
- 259 CHESTNUT FADE
- 291 CRANBERRY FADE
- 292 MARINE BLUE FADE
- 302 INCA GOLD BURST
- 310 BROOKLYN BURST
- 330 IVORY PEARL
- 331 BLACK PEARL
- 332 RED PEARL
- 333 PURPLE METALLIC
- 334 RED METALLIC
- 335 BLACK CHERRY
- 342 VINTAGE TOBACCO BURST
- 355 ANTIQUE WALNUT
- 356 TANGERINE DREAM
- 363 BLACK SPARKLE FADE
- 368 BLACK SILVER BURST
- 369 PURPLE SPARKLE BURST
- 376 ULTRA BLUE FADE
- 377 SCARLET SPARKLE BURST
- 378 MIDNIGHT SPARKLE
- 388 SHAMROCK GREEN
- 389 MATTE LIQUID AMBER
- 393 PURPLE CRAZE II

## CONCERT SNARE DRUMS

|          |     |                            |
|----------|-----|----------------------------|
| PHM      | 204 | HIGH GLOSS WALNUT BORDEAUX |
| PHP, PHF | 101 | WALNUT LACQUER             |
| PHP, PHF | 103 | PIANO BLACK                |
| PHA      | -   | BRUSHED ALUMINUM           |
| PHB      | -   | BLACK NICKEL BRASS         |
| PHX      | 210 | MATTE WALNUT ( MAHOGANY )  |
| SYP      | 138 | ANTIQUE SUNBURST           |
| CRP      | 102 | NATURAL MAPLE              |
| CRP      | 103 | PIANO BLACK                |

## CONCERT TOMS

|     |     |                           |
|-----|-----|---------------------------|
| PHA | 210 | MATTE WALNUT ( MAHOGANY ) |
| PHM | 201 | MATTE WALNUT (MAPLE)      |
| PTE | 46  | MIDNIGHT BLACK            |

## CONCERT BASS DRUMS

|     |     |                           |
|-----|-----|---------------------------|
| PBA | 210 | MATTE WALNUT ( MAHOGANY ) |
| PBM | 201 | MATTE WALNUT (MAPLE)      |
| PBE | 46  | MIDNIGHT BLACK            |

## VARSITY LACQUER FINISHES SPECIAL ORDER ONLY

|        | FADE TOP | FADE BOTTOM | BURST | SPIRAL |
|--------|----------|-------------|-------|--------|
| BLUE   | #962     | #961        | #960  | #990   |
| YELLOW | #965     | #964        | #963  | #991   |
| RED    | #968     | #967        | #966  | #992   |
| GREEN  | #971     | #970        | #969  | #993   |
| GARNET | #974     | #973        | #972  | #994   |
| PURPLE | #977     | #976        | #975  | #995   |
| ORANGE | #980     | #979        | #978  | #996   |
| BLACK  | #982     | #981        | #368  | #997   |

VARSITY FINISHES USE THE STANDARD SCHOLASTIC COLOR PALETTE. FADES AND BURST ARE DONE OVER A BASE COAT OF #360 SILVER SPARKLE. SPIRAL FINISHES USE A BASE COAT OF BLACK.

---

**IMPORTANT NOTICE**

This price list replaces our August 2014 price list reflecting our line of new products. Please refer to the latest Pearl catalogs for more details. Products listed herein may be limited or discontinued. To improve the design, quality and performance of our instruments the Pearl Corporation reserves the right to change specifications and prices without notice. All merchandise will be shipped at prevailing prices. All prices are F.O.B. Nashville, TN and listed in U.S. Dollars.

Pearl Corporation  
Corporate Headquarters  
549 Metroplex Dr.  
P.O. Box 111240  
Nashville, Tennessee 37211-3140  
(615) 833-4477  
FAX (615) 833-6242



RETPL115